



Single/Dual/Quad, Ultra-High-Speed, +3V/+5V, Beyond-the-Rails Comparators

General Description

The MAX961–MAX964/MAX997/MAX999 are low-power, ultra-high-speed comparators with internal hysteresis. These devices are optimized for single +3V or +5V operation. The input common-mode range extends 100mV Beyond-the-Rails™, and the outputs can sink or source 4mA to within 0.52V of GND and V_{CC}. Propagation delay is 4.5ns (5mV overdrive), while supply current is 5mA per comparator.

The MAX961/MAX963/MAX964 and MAX997 have a shutdown mode in which they consume only 270µA supply current per comparator. The MAX961/MAX963 provide complementary outputs and a latch-enable feature. Latch enable allows the user to hold a valid comparator output. The MAX999 is available in a tiny SOT23-5 package. The single MAX961/MAX997 and dual MAX962 are available in space-saving 8-pin µMAX packages.

Applications

Single 3V/5V Systems
 Portable/Battery-Powered Systems
 Threshold Detectors/Discriminators
 GPS Receivers
 Line Receivers
 Zero-Crossing Detectors
 High-Speed Sampling Circuits

Selector Guide

PART	NO. OF COMPARATORS	COMPLEMENTARY OUTPUT	SHUTDOWN	LATCH ENABLE	PACKAGE
MAX961	1	Yes	Yes	Yes	8 SO/µMAX
MAX962	2	No	No	No	8 SO/µMAX
MAX963	2	Yes	Yes	Yes	14 SO
MAX964	4	No	Yes	No	16 SO/QSOP
MAX997	1	No	Yes	No	8 SO/µMAX
MAX999	1	No	No	No	5 SOT23

Beyond-the-Rails is a trademark of Maxim Integrated Products, Inc.

Features

- ◆ Ultra-Fast, 4.5ns Propagation Delay
- ◆ Ideal for +3V and +5V Single-Supply Applications
- ◆ Beyond-the-Rails Input Voltage Range
- ◆ Low, 5mA Supply Current (MAX997/MAX999)
- ◆ 3.5mV Internal Hysteresis for Clean Switching
- ◆ Output Latch (MAX961/MAX963)
- ◆ TTL/CMOS-Compatible Outputs
- ◆ 270µA Shutdown Current per Comparator (MAX961/MAX963/MAX964/MAX997)
- ◆ Available in Space-Saving Packages:
 - 5-Pin SOT23 (MAX999)
 - 8-Pin µMAX (MAX961/MAX962/MAX997)
 - 16-Pin QSOP (MAX964)

Ordering Information

PART	TEMP RANGE	PIN-PACKAGE	SOT TOP MARK
MAX961ESA	-40°C to +85°C	8 SO	—
MAX961EUA	-40°C to +85°C	8 µMAX	—
MAX962ESA	-40°C to +85°C	8 SO	—
MAX962EUA	-40°C to +85°C	8 µMAX	—
MAX963ESD	-40°C to +85°C	14 SO	—
MAX964ESE	-40°C to +85°C	16 Narrow SO	—
MAX964EEE	-40°C to +85°C	16 QSOP	—
MAX997ESA	-40°C to +85°C	8 SO	—
MAX997EUA	-40°C to +85°C	8 µMAX	—
MAX999EUK-T	-40°C to +85°C	5 SOT23-5	ACAB

Pin Configurations

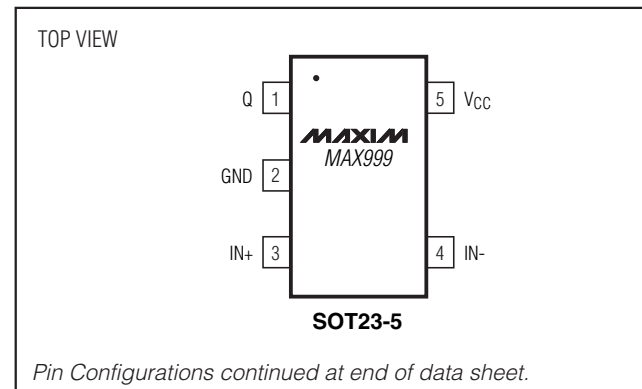

MAX961–MAX964/MAX997/MAX999



Single/Dual/Quad, Ultra-High-Speed, +3V/+5V, Beyond-the-Rails Comparators

ABSOLUTE MAXIMUM RATINGS

Supply Voltage, VCC to GND.....	-0.3V to +6V	14-Pin SO (derate 8.33mW/°C above +70°C).....	667mW/°C
All Other Pins.....	-0.3V to (VCC + 0.3V)	16-Pin SO (derate 8.70mW/°C above +70°C).....	696mW/°C
Duration of Output Short Circuit to GND or VCC	Continuous	16-Pin QSOP (derate 8.33mW/°C above +70°C)....	667mW/°C
Continuous Power Dissipation (TA = +70°C)		Operating Temperature Range	
5-Pin SOT23 (derate 7.1mW/°C above +70°C).....	571mW/°C	MAX96_E/MAX99_E.....	-40°C to +85°C
8-Pin SO (derate 5.88mW/°C above +70°C).....	471mW/°C	Storage Temperature Range	-65°C to +160°C
8-Pin μMAX (derate 4.10mW/°C above +70°C).....	330mW/°C	Lead Temperature (soldering, 10sec).....	+300°C

Stresses beyond those listed under "Absolute Maximum Ratings" may cause permanent damage to the device. These are stress ratings only, and functional operation of the device at these or any other conditions beyond those indicated in the operational sections of the specifications is not implied. Exposure to absolute maximum rating conditions for extended periods may affect device reliability.

ELECTRICAL CHARACTERISTICS

(VCC = +2.7V to +5.5V, VCM = 0V, COUT = 5pF, VSHDN = 0V, VLE = 0V, unless otherwise noted.) (Note 1)

PARAMETER	SYMBOL	CONDITIONS	TA = +25°C			TMIN to TMAX		UNITS
			MIN	TYP	MAX	MIN	MAX	
Supply Voltage	VCC	Inferred by PSRR	2.7		5.5	2.7	5.5	V
Input Common-Mode Voltage Range	VCMR	(Note 2)	-0.1		VCC + 0.1	-0.1	VCC + 0.1	V
Input-Referred Trip Points	VTRIP	VCM = -0.1V or 5.1V, VCC = 5V (Note 3)		±2.0	±3.5		±6.5	mV
		All other packages		±2.0	±3.5		±4.0	
Input-Referred Hysteresis				3.5				mV
Input Offset Voltage	VOS	VCM = -0.1V or 5.1V, VCC = 5V (Note 4)		±0.5	±1.5		±4.5	mV
		All other packages		±0.5	±1.5		±2.0	
Input Bias Current	IB	VIN+ = VIN- = 0V or VCC, VCC = 5V			±15		±30	μA
		All other packages			±15		±15	
Differential Input Clamp Voltage		VCC = 5.5V, VIN- = 0V, IIN+ = 100μA		2.1				V
Input Capacitance				3				pF
Differential Input Impedance	RIND	VCC = 5V		8				kΩ
Common-Mode Input Impedance	RINCM	VCC = 5V		130				kΩ
Common-Mode Rejection Ratio	CMRR	VCC = 5V, VCM = -0.1V to 5.1V (Note 5)		0.1	0.3		1.0	mV/V
		All other packages		0.1	0.3		0.5	
Power-Supply Rejection Ratio	PSRR	VCM = 0V (Note 6)		0.05	0.3		0.3	mV/V
Output High Voltage	VOH	ISOURCE = 4mA		VCC - 0.52			VCC - 0.52	V
Output Low Voltage	VOL	ISINK = 4mA			0.52		0.52	V
Capacitive Slew Current		VOUT = 1.4V, VCC = 2.7V	30	60				mA

Single/Dual/Quad, Ultra-High-Speed, +3V/+5V, Beyond-the-Rails Comparators

MAX961-MAX964/MAX997/MAX999

ELECTRICAL CHARACTERISTICS (continued)

(V_{CC} = +2.7V to +5.5V, V_{CM} = 0V, C_{OUT} = 5pF, V_{SHDN} = 0V, V_{LE} = 0V, unless otherwise noted.) (Note 1)

PARAMETER	SYMBOL	CONDITIONS	T _A = +25°C			T _{MIN} to T _{MAX}		UNITS
			MIN	TYP	MAX	MIN	MAX	
Output Capacitance			4					pF
Supply Current per Comparator	I _{CC}	MAX961/MAX963, V _{CC} = 5V	7.2			11		mA
		MAX962/MAX964, V _{CC} = 5V	5			8		
		MAX997/MAX999, V _{CC} = 5V	5			6.5		
Shutdown Supply Current per Comparator	I _{SHDN}	MAX961/MAX963/MAX964/MAX997, V _{CC} = 5V	0.27			0.5		mA
Shutdown Output Leakage Current		MAX961/MAX963/MAX964/MAX997, V _{OUT} = 0.5V and V _{CC} - 0.5V				1		μA
Rise/Fall Time	t _R , t _F	V _{CC} = 5V	2.3					ns
Logic Input High	V _{IH}		(V _{CC} / 2) + 0.4			(V _{CC} / 2) + 0.4		V
Logic Input Low	V _{IL}					(V _{CC} / 2) - 0.4		V
Logic Input Current	I _{IL} , I _{IH}	V _{LOGIC} = 0V or V _{CC}				±15		μA
Propagation Delay	t _{PD}	5mV overdrive (Note 7)	4.5			7		ns
Differential Propagation Delay	t _{PD}	Between any two channels or outputs (Q/Q̄)	0.3					ns
Propagation-Delay Skew	t _{SKEW}	Between t _{PD-} and t _{PD+}	0.3					ns
Data-to-Latch Setup Time	t _{SU}	MAX961/MAX963 (Note 8)				5		ns
Latch-to-Data Hold Time	t _H	MAX961/MAX963 (Note 8)				5		ns
Latch Pulse Width	t _{LPW}	MAX961/MAX963 (Note 8)				5		ns
Latch Propagation Delay	t _{LPD}	MAX961/MAX963 (Note 8)				10		ns
Shutdown Time	t _{OFF}	Delay until output is high-Z (> 10kΩ)	150					ns
Shutdown Disable Time	t _{ON}	Delay until output is valid	250					ns

Note 1: The MAX961EUA/MAX962EUA/MAX997EUA/MAX999EUK are 100% production tested at T_A = +25°C; all temperature specifications are guaranteed by design.

Note 2: Inferred by CMRR. Either input can be driven to the absolute maximum limit without false output inversion, provided that the other input is within the input voltage range.

Note 3: The input-referred trip points are the extremities of the differential input voltage required to make the comparator output change state. The difference between the upper and lower trip points is equal to the width of the input-referred hysteresis zone. (See Figure 1.)

Note 4: Input offset voltage is defined as the mean of the trip points.

Note 5: CMRR = (V_{OSL} - V_{OSH}) / 5.2V, where V_{OSL} is the offset at V_{CM} = -0.1V and V_{OSH} is the offset at V_{CM} = 5.1V.

Note 6: PSRR = (V_{OS2.7} - V_{OS5.5}) / 2.8V, where V_{OS2.7} is the offset voltage at V_{CC} = 2.7V, and V_{OS5.5} is the offset voltage at V_{CC} = 5.5V.

Note 7: Propagation delay for these high-speed comparators is guaranteed by design characterization because it cannot be accurately measured using automatic test equipment. A statistically significant sample of devices is characterized with a 200mV step and 100mV overdrive over the full temperature range. Propagation delay can be guaranteed by this characterization, since DC tests ensure that all internal bias conditions are correct. For low overdrive conditions, V_{TRIP} is added to the overdrive.

Note 8: Guaranteed by design.

Single/Dual/Quad, Ultra-High-Speed, +3V/+5V, Beyond-the-Rails Comparators

Typical Operating Characteristics

($V_{CC} = +3.0V$, $C_{LOAD} = 5pF$, 5mV of overdrive, $T_A = +25^\circ C$, unless otherwise noted.)

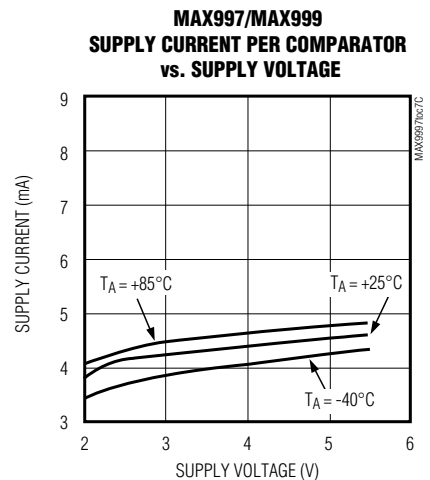
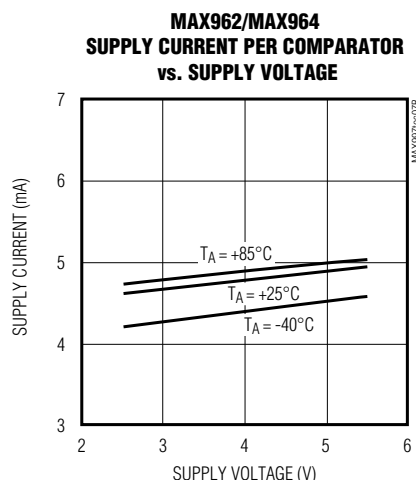
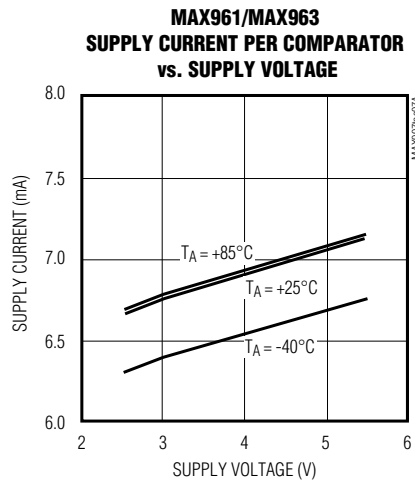
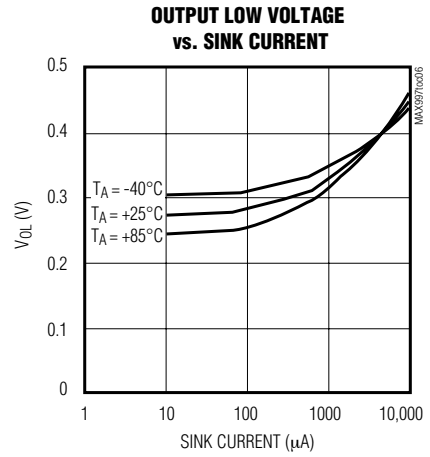
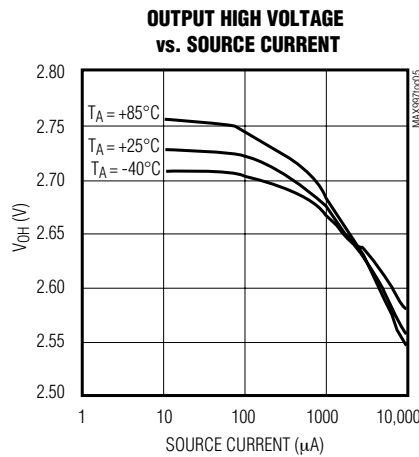
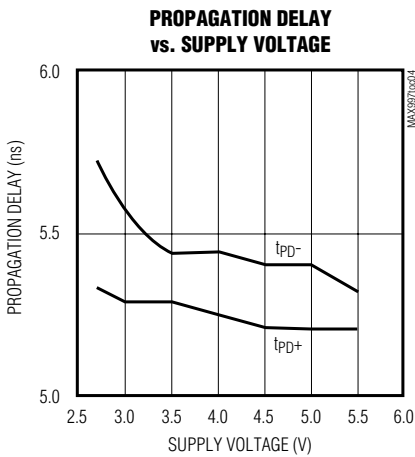
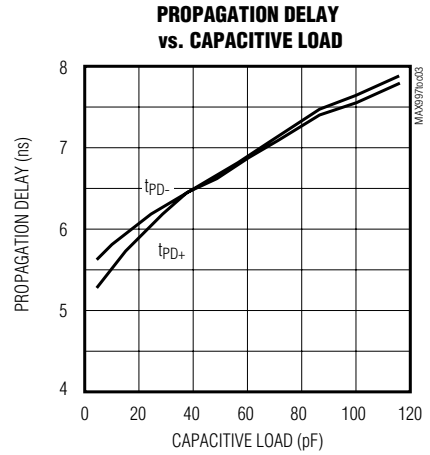
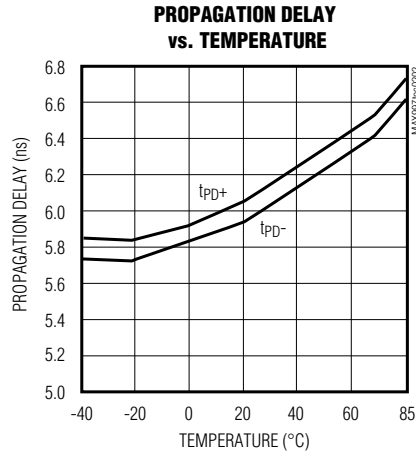
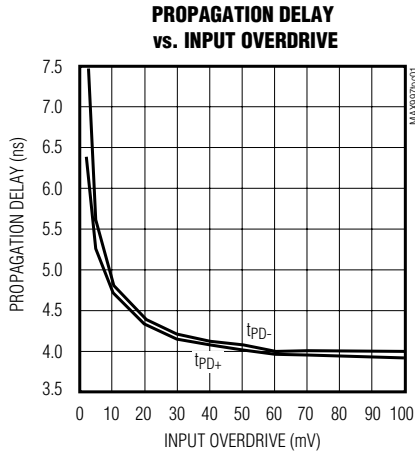

Single/Dual/Quad, Ultra-High-Speed, +3V/+5V, Beyond-the-Rails Comparators

Typical Operating Characteristics (continued)

($V_{CC} = +3.0V$, $C_{LOAD} = 5pF$, 5mV of overdrive, $T_A = +25^\circ C$, unless otherwise noted.)

MAX961-MAX964/MAX997/MAX999

**MAX961/MAX963/MAX964/MAX997
SHUTDOWN SUPPLY CURRENT
vs. TEMPERATURE**

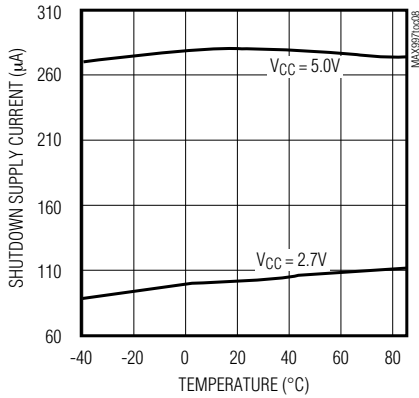

**VOLTAGE TRIP POINT/INPUT OFFSET
VOLTAGE vs. TEMPERATURE**

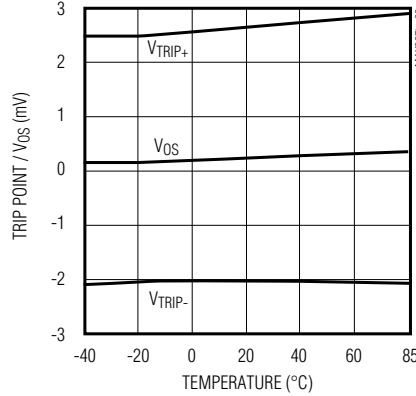

**VOLTAGE TRIP POINT/INPUT OFFSET
VOLTAGE vs. SUPPLY VOLTAGE**

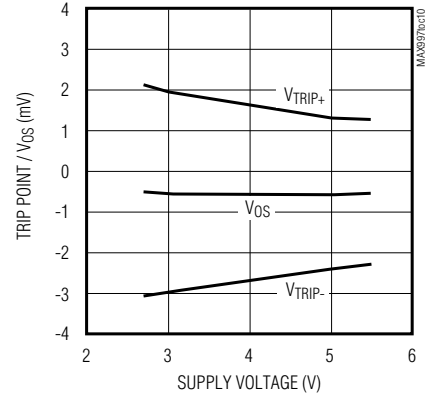

**INPUT BIAS CURRENT (I_{B+} , I_{B-})
vs. COMMON-MODE VOLTAGE**

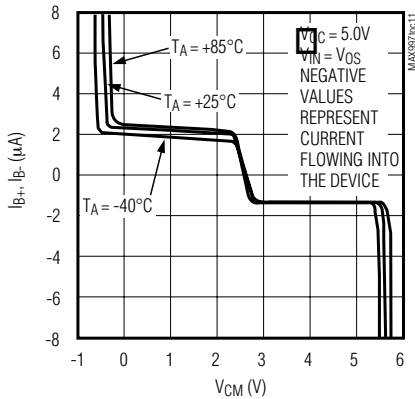

**INPUT BIAS CURRENT/INPUT OFFSET
CURRENT vs. TEMPERATURE**

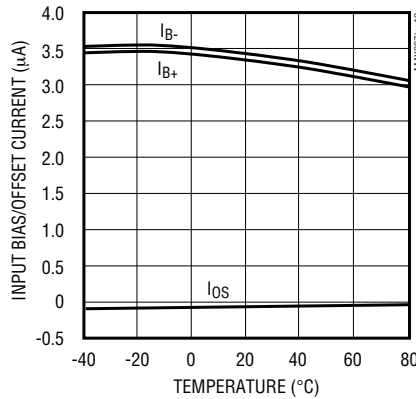

**SHORT-CIRCUIT OUTPUT CURRENT
vs. TEMPERATURE**

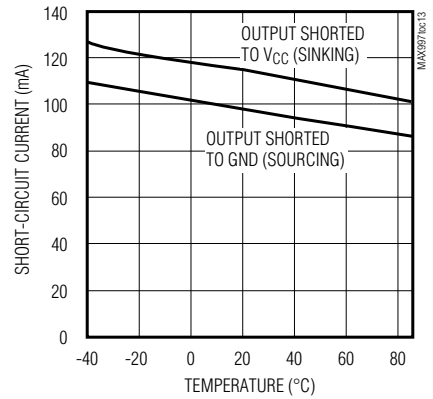

50MHz RESPONSE

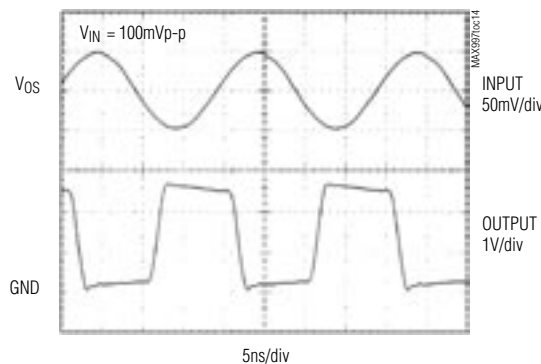

Single/Dual/Quad, Ultra-High-Speed, +3V/+5V, Beyond-the-Rails Comparators

Typical Operating Characteristics (continued)

(V_{CC} = +3.0V, C_{LOAD} = 5pF, 5mV of overdrive, T_A = +25°C, unless otherwise noted.)

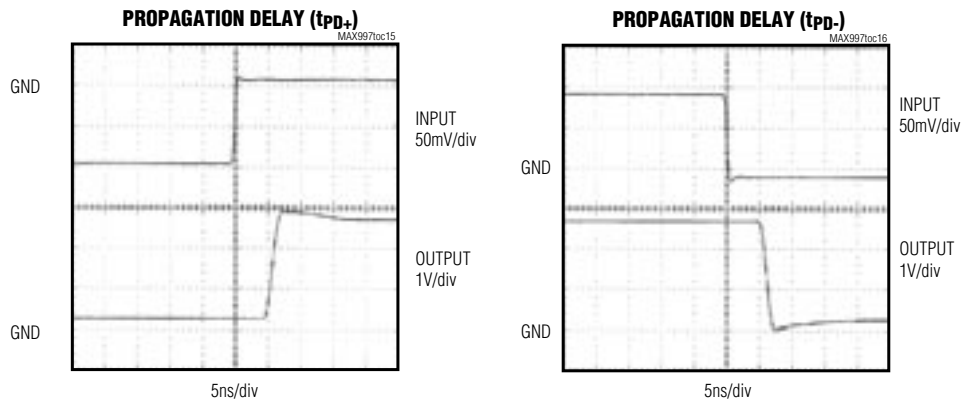

Pin Description

PIN						NAME	FUNCTION
MAX997	MAX999	MAX961	MAX962	MAX963	MAX964		
1, 5	—	—	—	—	—	N.C.	No Connection
2	4	2	2	1	1	IN-, INA-	Comparator A Inverting Input
3	3	1	1	2	2	IN+, INA+	Comparator A Noninverting Input
—	—	4	—	3, 5	—	LE, LEA, LEB	Latch-Enable Input. The output latches when LE_ is high. The latch is transparent when LE_ is low.
4	2	5	5	4, 11	12	GND	Ground
—	—	—	—	—	16	N.C.	No Connect. Connect to GND to prevent parasitic feedback.
—	—	—	4	6	3	INB-	Comparator B Inverting Input
—	—	—	3	7	4	INB+	Comparator B Noninverting Input
—	—	—	—	—	5	INC-	Comparator C Inverting Input
—	—	—	—	—	6	INC+	Comparator C Noninverting Input
—	—	—	—	—	7	IND-	Comparator D Inverting Input
—	—	—	—	—	8	IND+	Comparator D Noninverting Input
8	—	3	—	8	9	SHDN	Shutdown Input. The device shuts down when SHDN is high.
—	—	—	6	9	14	QB	Comparator B Output
—	—	—	—	—	11	QC	Comparator C Output
—	—	—	—	—	10	QD	Comparator D Output
—	—	—	—	10	—	QB̄	Comparator B Complementary Output
7	5	8	8	12	13	V _{CC}	Positive Supply Input (V _{CC} to GND must be ≤5.5V)
6	1	6	7	13	15	Q, QA	Comparator A TTL Output
—	—	7	—	14	—	Q̄, QĀ	Comparator A Complementary Output

Single/Dual/Quad, Ultra-High-Speed, +3V/+5V, Beyond-the-Rails Comparators

Detailed Description

The MAX961-MAX964/MAX997/MAX999 single-supply comparators feature internal hysteresis, ultra-high-speed operation, and low power consumption. Their outputs are guaranteed to pull within 0.52V of either rail without external pull-up or pull-down circuitry. Beyond-the-Rails™ input voltage range and low-voltage, single-supply operation make these devices ideal for portable equipment. These comparators all interface directly to CMOS logic.

Timing

Most high-speed comparators oscillate in the linear region because of noise or undesirable parasitic feedback. This can occur when the voltage on one input is close to or equal to the voltage on the other input. These devices have a small amount of internal hysteresis to counter parasitic effects and noise.

The added hysteresis of the MAX961-MAX964/MAX997/MAX999 creates two trip points: one for the rising input voltage and one for the falling input voltage (Figure 1). The difference between the trip points is the hysteresis. When the comparator's input voltages are equal, the hysteresis effectively causes one comparator input

voltage to move quickly past the other, thus taking the input out of the region where oscillation occurs. Standard comparators require hysteresis to be added with external resistors. The fixed internal hysteresis eliminates these resistors.

The MAX961/MAX963 include internal latches that allow storage of comparison results. LE has a high input impedance. If LE is low, the latch is transparent (i.e., the comparator operates as though the latch is not present). The comparator's output state is stored when LE is pulled high. All timing constraints must be met when using the latch function (Figure 2).

Input Stage Circuitry

The MAX961-MAX964/MAX997/MAX999 include internal protection circuitry that prevents damage to the precision input stage from large differential input voltages. This protection circuitry consists of two groups of three front-to-back diodes between IN+ and IN-, as well as two 200Ω resistors (Figure 3). The diodes limit the differential voltage applied to the comparator's internal circuitry to no more than 3V_F, where V_F is the diode's forward-voltage drop (about 0.7V at +25°C).

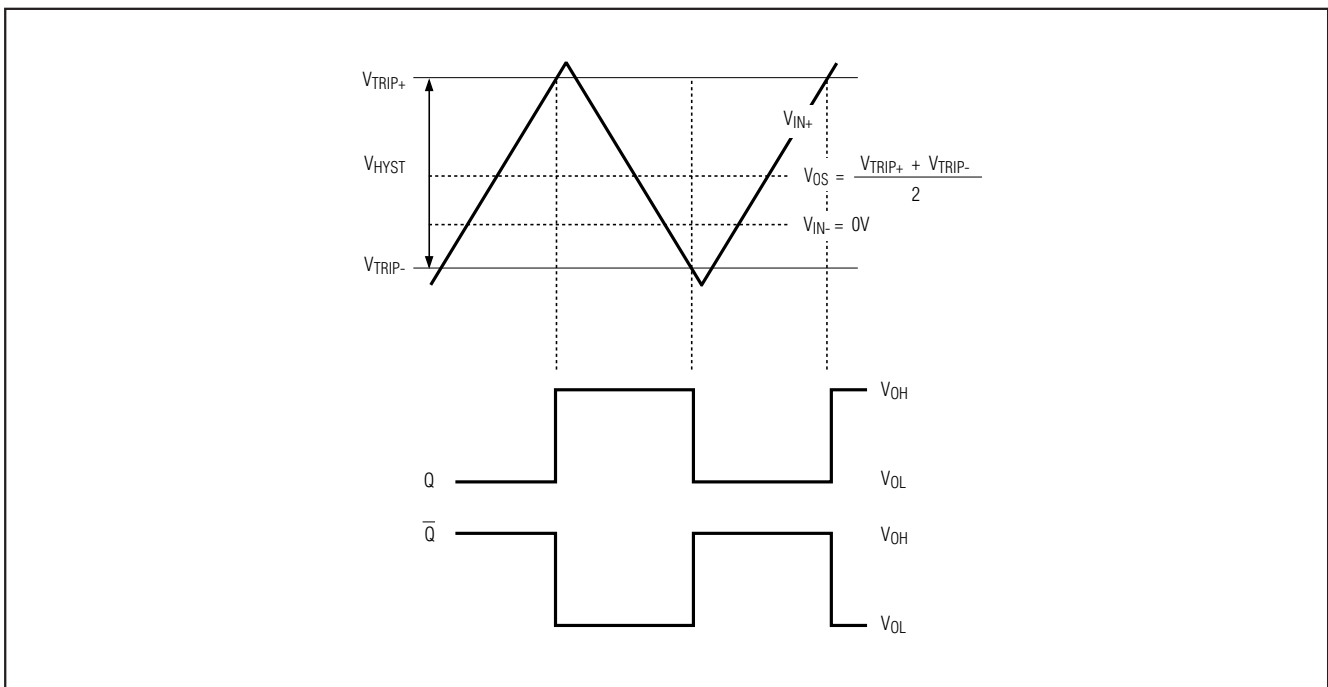

Figure 1. Input and Output Waveforms, Noninverting Input Varied

Single/Dual/Quad, Ultra-High-Speed, +3V/+5V, Beyond-the-Rails Comparators

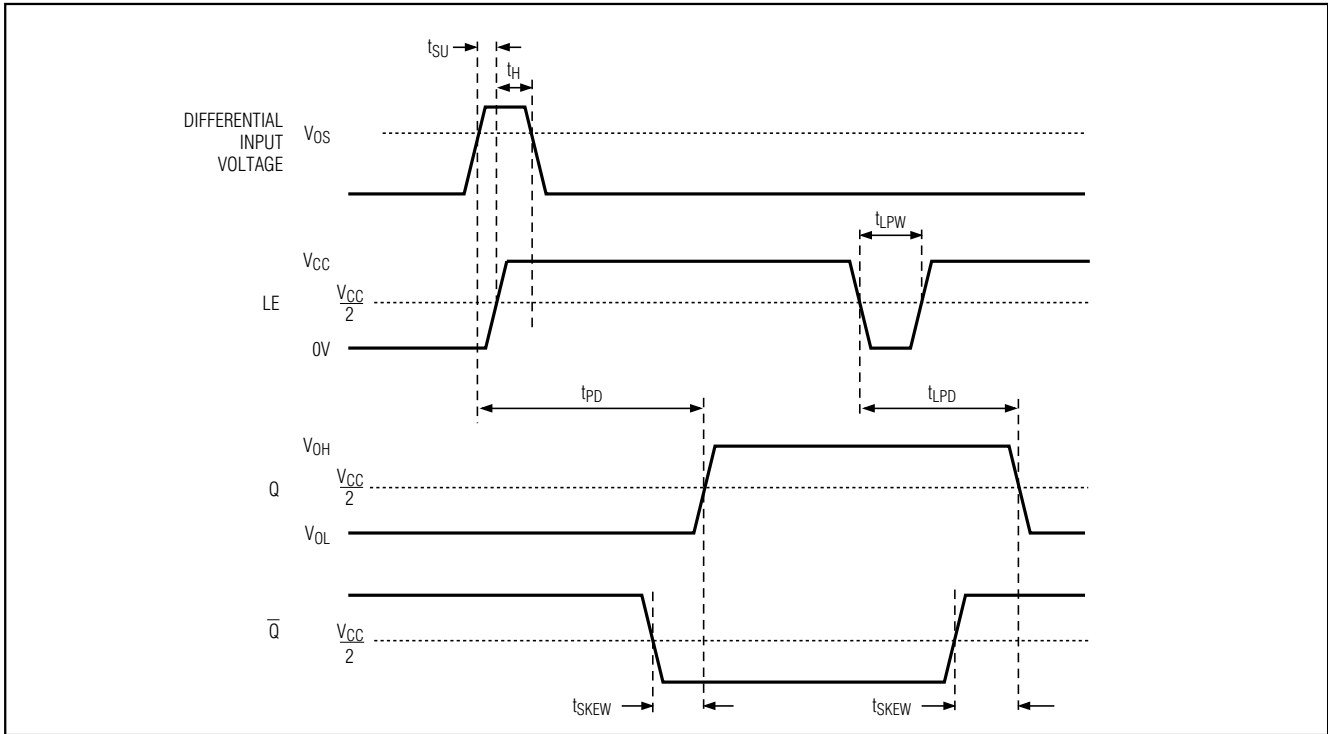

Figure 2. MAX961/MAX963 Timing Diagram

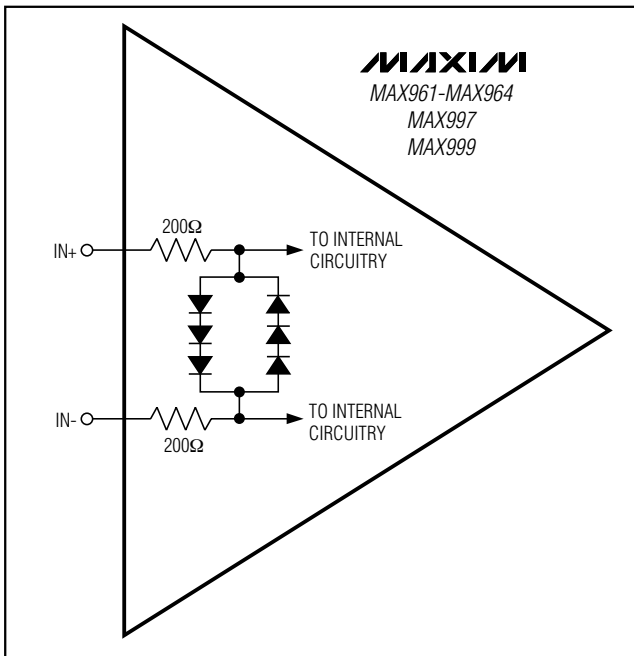

Figure 3. Input Stage Circuitry

For a large differential input voltage (exceeding 3V_F), this protection circuitry increases the input bias current at IN+ (source) and IN- (sink).

$$\text{Input current} = \frac{(\text{IN}+ - \text{IN}-) - 3V_F}{2 \times 200}$$

Input currents with large differential input voltages should not be confused with input bias currents (I_B). As long as the differential input voltage is less than 3V_F, this input current is less than 2I_B.

The input circuitry allows the MAX961-MAX964/MAX997/MAX999's input common-mode range to extend 100mV beyond both power-supply rails. The output remains in the correct logic state if one or both inputs are within the common-mode range. Taking either input outside the common-mode range causes the input to saturate and the propagation delay to increase.

Single/Dual/Quad, Ultra-High-Speed, +3V/+5V, Beyond-the-Rails Comparators

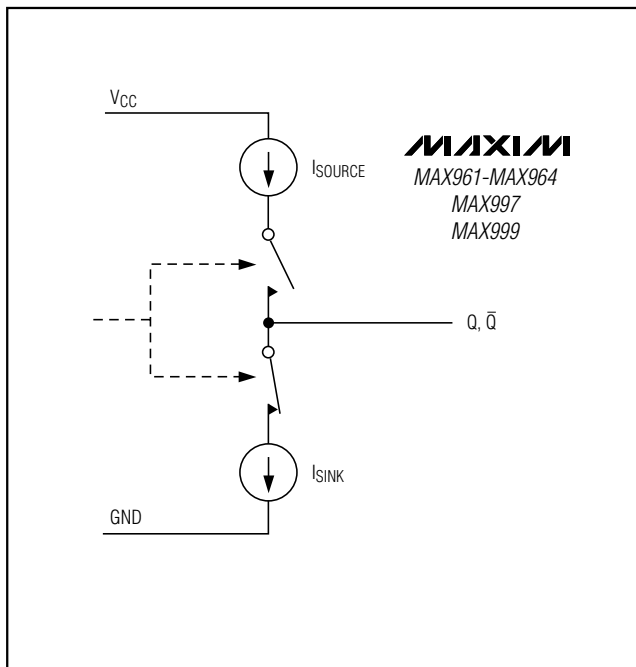

Figure 4. Output Stage Circuitry

Output Stage Circuitry

The MAX961–MAX964/MAX997/MAX999 contain a current-driven output stage, as shown in Figure 4. During an output transition, I_{SOURCE} or I_{SINK} is pushed or pulled to the output pin. The output source or sink current is high during the transition, creating a rapid slew rate. Once the output voltage reaches V_{OH} or V_{OL} , the source or sink current decreases to a small value, capable of maintaining the V_{OH} or V_{OL} in static condition. This decrease in current conserves power after an output transition has occurred.

One consequence of a current-driven output stage is a linear dependence between the slew rate and the load capacitance. A heavy capacitive load slows down the voltage output transition.

Shutdown Mode

When SHDN is high, the MAX961/MAX963/MAX964/MAX997 shut down. When shut down, the supply current drops to 270 μ A per comparator, and the outputs become high impedance. SHDN has a high input impedance. Connect SHDN to GND for normal operation. Exit shutdown with LE low; otherwise, the output is indeterminate.

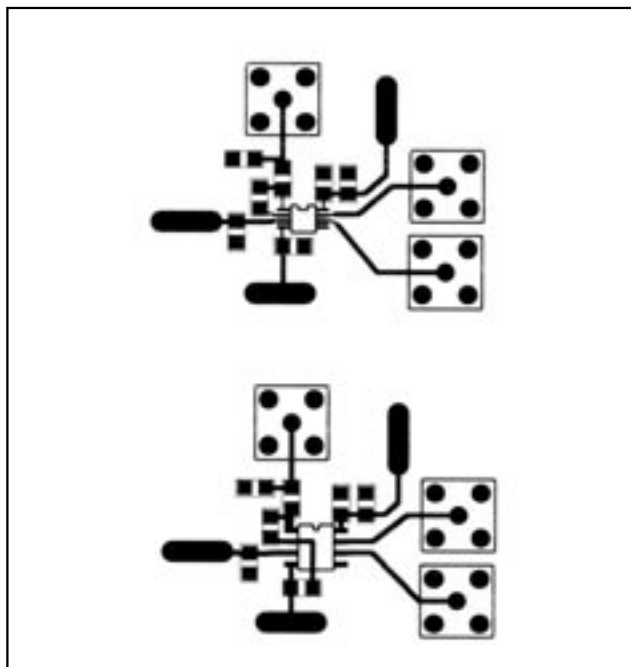

Figure 5. MAX961 PC Board Layout

Applications Information

Circuit Layout and Bypassing

The MAX961–MAX964/MAX997/MAX999's high bandwidth requires a high-speed layout. Follow these layout guidelines:

- 1) Use a printed circuit board with a good, unbroken, low-inductance ground plane.
- 2) Place a decoupling capacitor (a 0.1 μ F ceramic surface-mount capacitor is a good choice) as close to V_{CC} as possible.
- 3) On the inputs and outputs, keep lead lengths short to avoid unwanted parasitic feedback around the comparators. Keep inputs away from outputs. Keep impedance between the inputs low.
- 4) Solder the device directly to the printed circuit board rather than using a socket.
- 5) Refer to Figure 5 for a recommended circuit layout.
- 6) For slow-moving input signals, take care to prevent parasitic feedback. A small capacitor (100pF or less) placed between the inputs can help eliminate oscillations in the transition region. This capacitor causes negligible degradation to t_{PD} when the source impedance is low.

Single/Dual/Quad, Ultra-High-Speed, +3V/+5V, Beyond-the-Rails Comparators

Pin Configurations

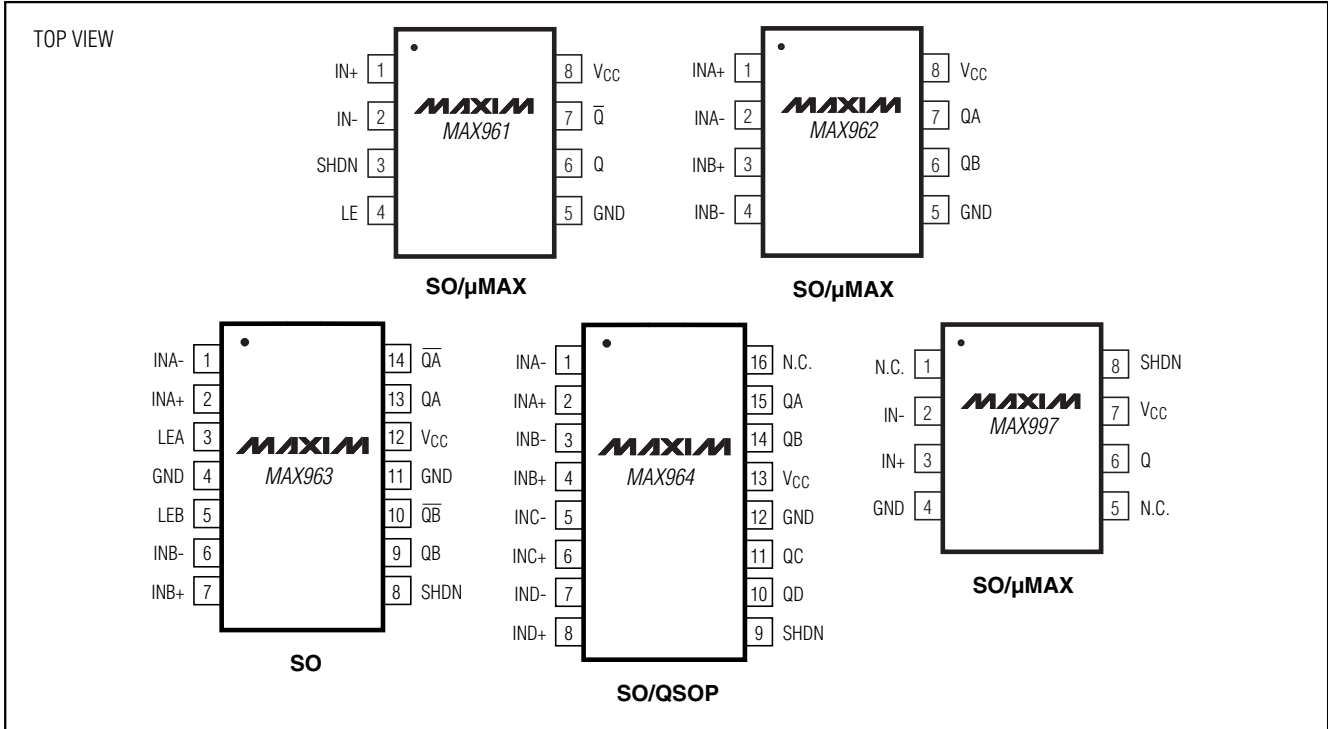

Chip Information

MAX961/MAX962 TRANSISTOR COUNT: 286

MAX963/MAX964 TRANSISTOR COUNT: 607

MAX997/MAX999 TRANSISTOR COUNT: 142

Single/Dual/Quad, Ultra-High-Speed, +3V/+5V, Beyond-the-Rails Comparators

Package Information

(The package drawing(s) in this data sheet may not reflect the most current specifications. For the latest package outline information go to www.maxim-ic.com/packages.)

MAX961-MAX964/MAX997/MAX999

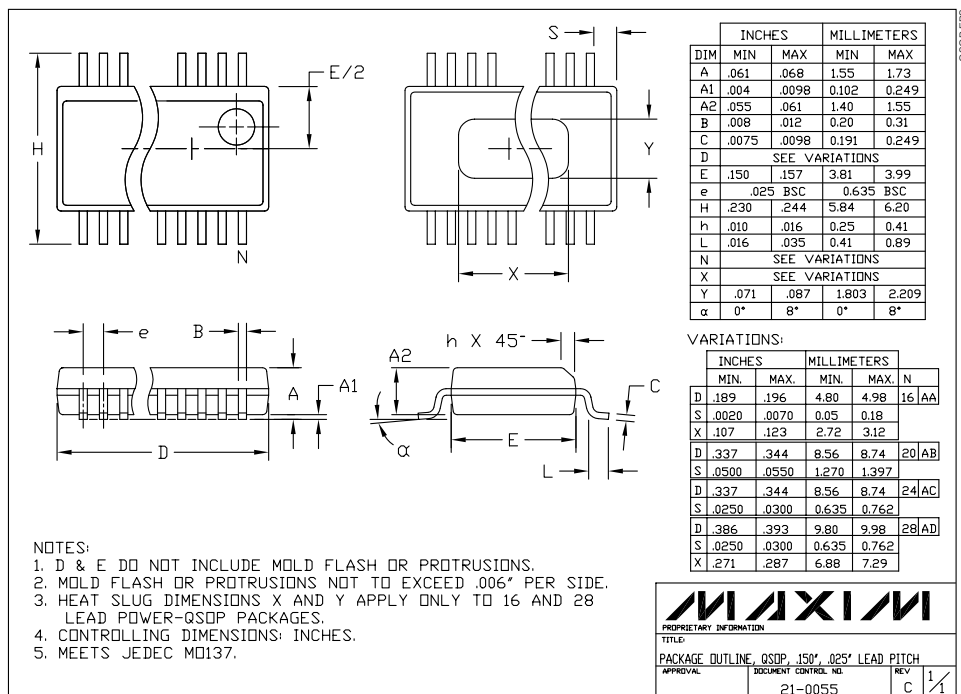
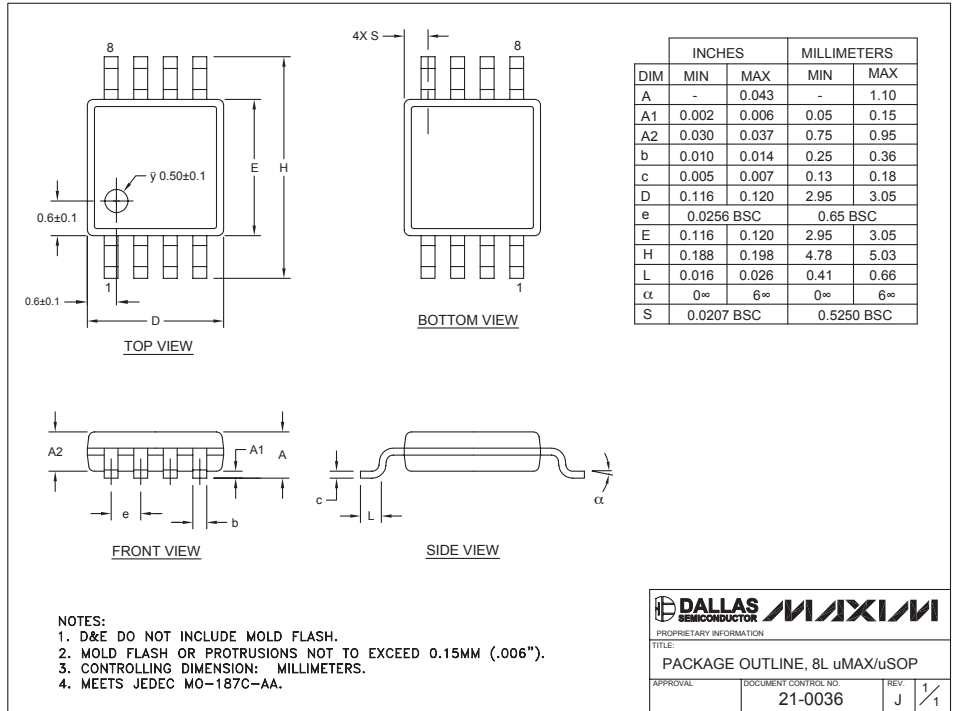

Single/Dual/Quad, Ultra-High-Speed, +3V/+5V, Beyond-the-Rails Comparators

Package Information (continued)

(The package drawing(s) in this data sheet may not reflect the most current specifications. For the latest package outline information go to www.maxim-ic.com/packages.)

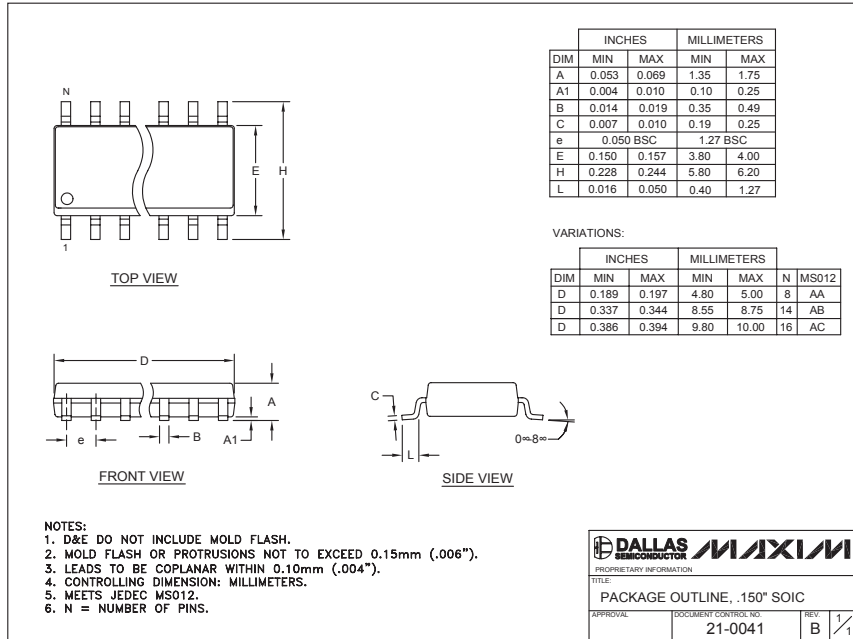

SOT-23, 5L EPS

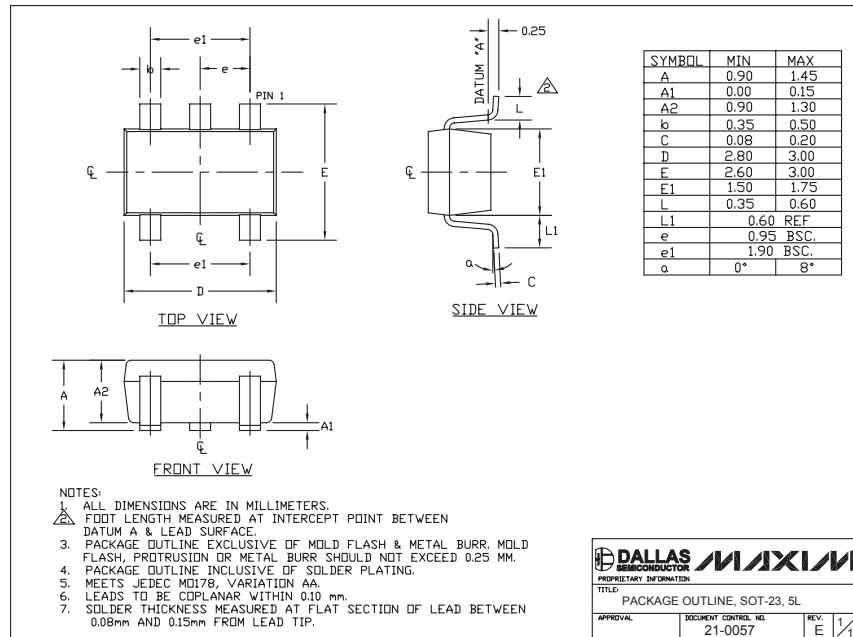

SOT-23, 5L EPS

Maxim cannot assume responsibility for use of any circuitry other than circuitry entirely embodied in a Maxim product. No circuit patent licenses are implied. Maxim reserves the right to change the circuitry and specifications without notice at any time.