

Ordering number C11425
Description 1

Family	Strada-T	FWHM	Asym degrees
Type	Lens	Efficiency	93 %
LED	Oslon SSL 80	cd/lm	-
Color	Clear	Gerber File	Available
Diameter	19.6 x 15.5 mm		
Height	10.7 mm		
Style	Rectang		
Optic Material	PMMA		
Holder Material	-		
Fastening	-		
Status	Ready		

Ordering number CA11426
Description 1

Family	Strada-T	FWHM	Asym degrees
Type	Assembly	Efficiency	92 %
LED	Oslon SSL 80	cd/lm	-
Color	Clear	Gerber File	Available
Diameter	19.6 x 15.5 mm		
Height	10.7 mm		
Style	Rectang		
Optic Material	PMMA		
Holder Material	-		
Fastening	-		
Status	Ready		



PRODUCT DATASHEET
Strada-T series
last update 14/11/2012



NOTE: The typical divergence will be changed by different color, chip size and chip position tolerance. The typical total divergence is the full angle measured where the luminous intensity is half of the peak value.

D C B A

4

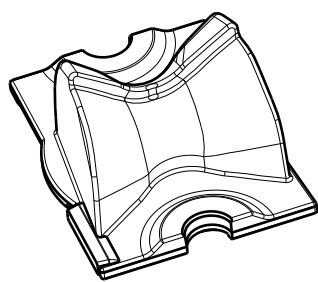

Isometric view

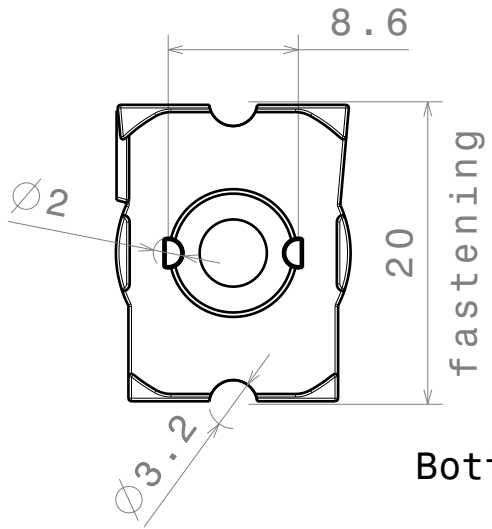

Bottom view

3

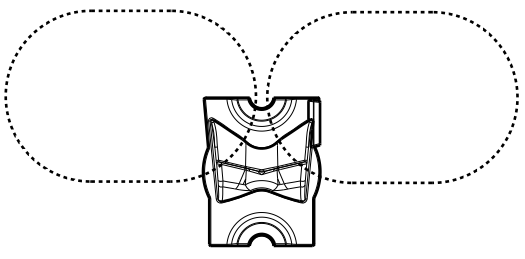

Beam direction

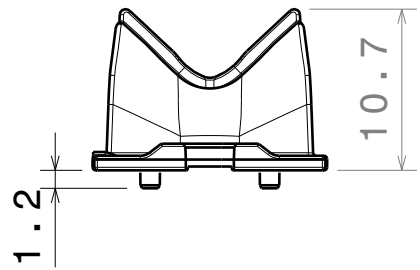

Front view

2

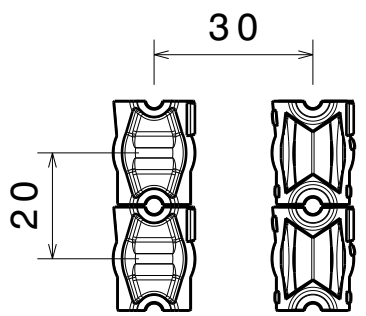

Strada lens arrangement recommendation

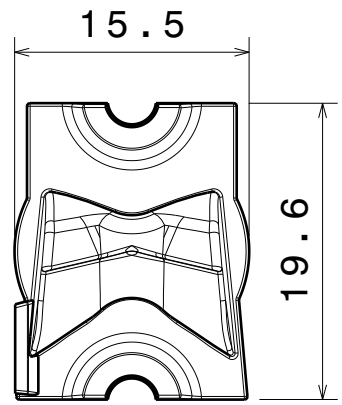

Top view

MATERIALS
 Lens: PMMA
 Tape(optional): PU Foam

Part no. with tape fastening: CA11426_Strada-T-DW

This drawing is our property. It can't be reproduced or communicated without our written agreement.



Ledil Oy
 Tehdaskatu 13
 FIN-24100 SALO
 Finland

DRAWING TITLE

Datasheet Strada-T-DW Lens

DRAWN BY o1	DATE 17.05.2010
CHECKED BY pv	DATE 17.05.2010
DESIGNED BY hh	DATE 17.05.2010

SIZE A4	DRAWING NUMBER C11425	REV 1
SCALE 2:1	WEIGHT (g)	SHEET 1/1

1

1

D A