

Bourdon tube pressure gauge Model 213.53, liquid filling, stainless steel case

WIKA data sheet PM 02.12



Applications

- For measuring points with high dynamic pressure loads or vibrations
- For gaseous and liquid media that are not highly viscous or crystallising and will not attack copper alloy parts
- Hydraulics
- Compressors, shipbuilding

Special features

- Vibration and shock resistant
- Especially sturdy design
- NS 63 and 100 with German Lloyd and Gosstandart approval
- Scale ranges up to 0 ... 1000 bar



Bourdon tube pressure gauge, model 213.53.100,
lower mount

Description

Design

EN 837-1

Nominal size in mm

50, 63, 100

Accuracy class

NS 50, 63: 1.6

NS 100: 1.0

Scale ranges

NS 50: 0 ... 1 to 0 ... 400 bar

NS 63, 100: 0 ... 0.6 to 0 ... 1000 bar

or all other equivalent vacuum or combined pressure and vacuum ranges

Pressure limitation

NS 50, 63: Steady: 3/4 x full scale value

Fluctuating: 2/3 x full scale value

Short time: Full scale value

NS 100: Steady: Full scale value

Fluctuating: 0.9 x full scale value

Short time: 1.3 x full scale value

Permissible temperature

Ambient: -20 ... +60 °C

Medium: +60 °C maximum

Temperature effect

When the temperature of the measuring system deviates from the reference temperature (+20 °C):

Max. ±0.4 %/10 K of the span

Ingress protection

IP 65 per EN 60529 / IEC 529

Process connection

Cu-alloy,
lower mount (LM) or back mount (BM),
NS 50, 63: G ¼ B (male), 14 mm flats
NS 100: G ½ B (male), 22 mm flats

Pressure element

NS 50, 63:
< 60 bar: Cu-alloy, C-type
≥ 60 bar: Cu-alloy, helical type
NS 100:
< 100 bar: Cu-alloy, C-type
≥ 100 bar: Stainless steel 316L, helical type

Movement

Cu-alloy

Dial

NS 50, 63: Plastic ABS, white, with pointer stop pin
NS 100: Aluminium, white, black lettering

Pointer

NS 50, 63: Plastic, black
NS 100: Aluminium, black

Window

Plastic, crystal-clear

Case

Natural finish stainless steel, with pressure relief at case circumference, 12 o'clock.
O-ring seal between case and connection.
Scale ranges ≤ 0 ... 16 bar with compensating valve to vent case.

Bezel ring

Crimp ring, glossy finish stainless steel, triangular bezel

Filling liquid

Glycerine 99.7 %

Options

- Measuring system and movement from stainless steel (model 233.53)
- NS 100: Zero adjustment (in front)
- Increased medium temperature with special soft solder
 - NS 50, 63: 100 °C
 - NS 100: 150 °C
- Ambient temperature resistant -40 ... +60 °C with silicone oil filling
- Panel mounting flange, stainless steel, for back connection
- Surface mounting flange, stainless steel (not NS 50)
- Mounting clamp (for back connection)

Dimensions in mm

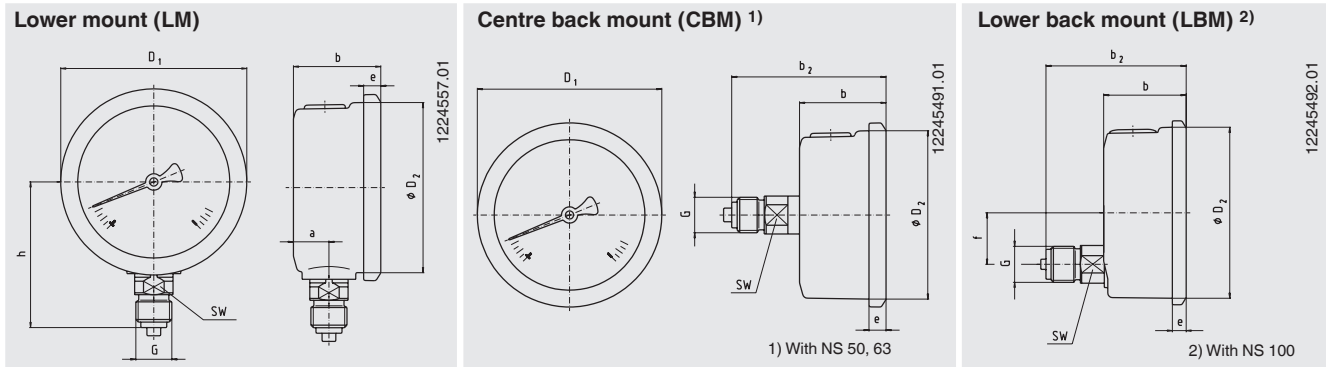

NS	Dimensions in mm										Weight in kg
	a	b ± 0.5	b ₂ ± 0.5	D ₁	D ₂	e	f	G	h ± 1	SW	
50	12	30	55	55	50	5.5	-	G ¼ B	48	14	0.15
63	13	32	56	68	62	6.5	-	G ¼ B	54	14	0.21
100	15.5	48	81.5	107	100	8	30	G ½ B	87	22	0.80

Process connection per EN 837-1 / 7.3

Ordering information

Model / Nominal size / Scale range / Connection size / Connection location / Options

© 2008 WIKA Alexander Wiegand SE & Co. KG, all rights reserved.
The specifications given in this document represent the state of engineering at the time of publishing.
We reserve the right to make modifications to the specifications and materials.



WIKAL Alexander Wiegand SE & Co. KG
Alexander-Wiegand-Straße 30
63911 Klingenberg/Germany
Tel. (+49) 9372/132-0
Fax (+49) 9372/132-406
E-mail info@wika.de
www.wika.de