

Installation Instructions

Original Instructions



440G-MZ Guardmaster Safety Switches

Catalog Number 440G-MZS20SNRJ, 440G-MZS20SNRJE, 440G-MZS20UNRJ, 440G-MZS20UNRJE, 440G-MZS20SNLJ, 440G-MZS20SNLJE, 440G-MZS20UNLJ, 440G-MZS20UNLJE



ATTENTION: Read this document and the documents that are listed in [Additional Resources on page 6](#) about installation, configuration, and operation of this equipment before you install, configure, operate, or maintain this product. Users are required to familiarize themselves with installation and wiring instructions, and requirements of all applicable codes, laws, and standards.

Only suitably trained personnel must perform activities including installation, adjustments, commissioning, use, assembly, disassembly, and maintenance in accordance with applicable code of practice.

If this equipment is used in a manner that the manufacturer does not specify, the protection that is provided by the equipment may be impaired.

Introduction



ATTENTION: Do not attempt to install this device unless the installation instructions have been studied and understood. This document acts as a guide for a typical installation and translations are available at rok.auto/literature. A user manual is also available (see [Additional Resources on page 6](#)).

Figure 1 - Assembly Overview

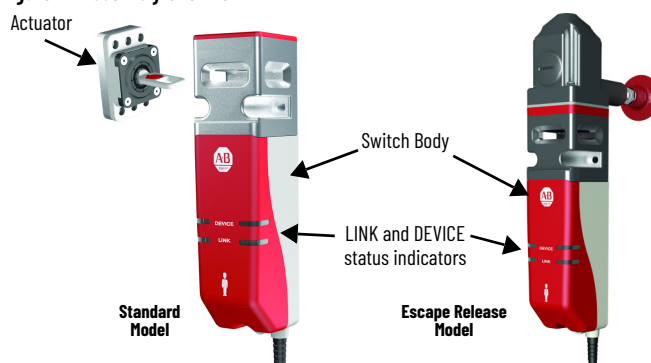

The 440G-MZ Guardmaster® Guard Locking Switch locks a guard door in the closed position and does not release it until the hazardous machine functions that are covered by the guard are in a safe condition. The safety control system only allows the hazardous machine functions to operate when the guard is closed and locked.

Qualified personnel must install the switch in accordance with these instructions.



ATTENTION: This device is intended to be part of the safety-related control system of a machine. Before installation, a risk assessment must be performed to determine whether the specifications of this device are suitable for all foreseeable operational and environmental characteristics of the application. See [Specifications on page 5](#) for certification information and ratings.

Use appropriate screws, bolts, or nuts that are fitted by tools to mount the switch and actuators to avoid the risk of tampering. Do not over torque the mounting hardware.

Topic	Page
Summary of Changes	1
Introduction	1
Installation	1
Commissioning – Unique Coded Models	2
Auxiliary Release	3
Approximate Dimensions	4
Pin Assignment	4
Connection in a GuardLink System	4
Specifications	5
Status Indicators	5
Lock Command	6
Catalog Number Explanation	6
Accessories	6
Additional Resources	6

Summary of Changes

This publication contains the following new or updated information. This list includes substantive updates only and is not intended to reflect all changes.

Topic	Page
Updated Catalog Number list.	1
Added Escape Release model to Figure 1 .	1
Updated Figure 4 .	2
Updated Minimum Distance Between Switches section.	2
Added Figure 9 .	3
Added Attention to Auxiliary Release section.	3
Added Escape Release section.	3
Added Figure 12 .	4
Updated Specifications section.	5
Updated Catalog Number Explanation section.	6
Updated Accessories table.	6

Installation



ATTENTION: Do not defeat, tamper, remove, or bypass this unit. Severe injury to personnel could result. The presence of spare actuators can compromise the integrity of the safety systems. Personal injury or death, property damage, or economic loss can result. Appropriate management controls, working procedures, and alternative protective measures should be introduced to control their use and availability.

Figure 2 - Required Mounting Hardware for Switch and Actuator



IMPORTANT Do not use a washer with the screw at the base of the switch body. The use of a washer causes the plastic to crack. Loctite 242 thread-locking adhesive is known to cause stress cracks in the plastic housing of the 440G-MZ safety switch and should not be used. Lab tests have determined that Loctite 425, a cyanoacrylate adhesive, does not cause cracking and can be considered if the faster cure time is acceptable in the application.

Figure 3 - Actuator Function



The flexible actuator bends, rotates, and slides to accommodate guard door misalignment (Figure 3). For optimal performance, verify that the locking bolt can enter and withdraw from the tongue actuator without binding. A separately mounted door latch is recommended to avoid door misalignment.

Figure 4 - Orientation of Assembled Switch

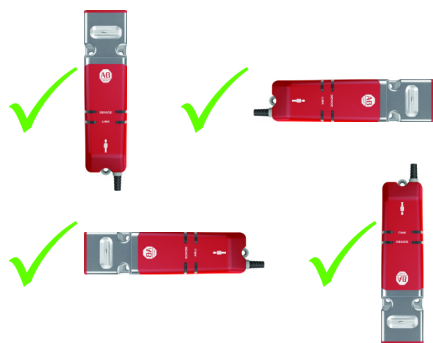

Minimum Distance Between Switches

As shown in Figure 5, a minimum of 100 mm (3.94 in.) must separate a pair of switches to help achieve correct operation.

IMPORTANT If the minimum separation distance is not observed, the electromagnetic fields interact causing crosstalk. Crosstalk can result in nuisance faults and false operation.

This restriction applies to any pair of Guardmaster safety switches that use RFID sensing technology, including 440N-Z SensaGuard™ interlocks, or TLS-Z and 440G-LZ guard locking switches.

Figure 5 - Minimum Distance between Switches [mm (in.)]

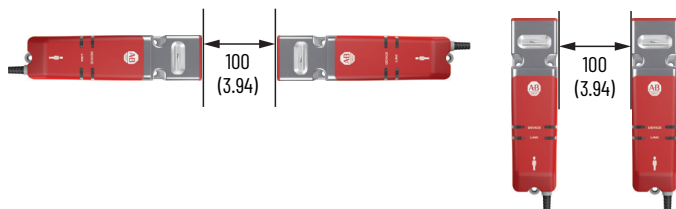
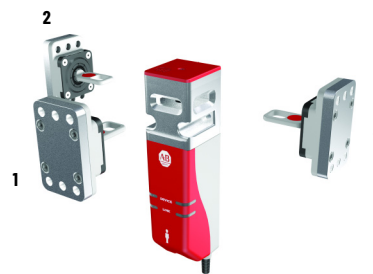

Figure 6 - Three Directions of Approach



Commissioning – Unique Coded Models

The actuator teach process is not performed at the factory and must be performed when the switch is first put into use. After the first-time learn, this process can be repeated up to seven more times with unique coded replacement actuators.

During commissioning, connect the switch as shown in Figure 7.

Figure 7 - Wiring

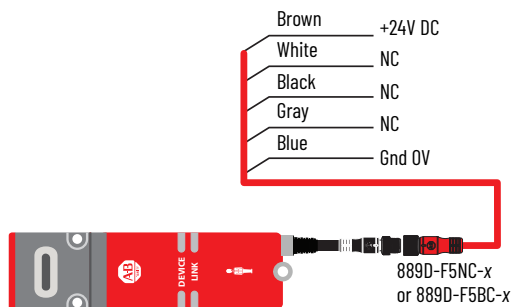

First Time Learn

Apply power to the switch without the actuator present. After the switch completes the power sequence (approximately 8 seconds), the status indicator flashes green eight times, which indicates the total number of times a new actuator can be learned. This status indicator sequence repeats until an actuator is inserted in the switch (in the guard closed position).

Table 1 - Commissioning Process for Unique Coded Switches

Step	State	Approximate Duration	Status Indicators
1	Actuator Present	15 s	<ul style="list-style-type: none"> Flashing 8x green, repeating ⁽¹⁾ Steady red (learning a replacement actuator)
2	Verifying Actuator	15 s	Flashing red/green, slow
3	Programming Switch	15 s	Flashing red/green, fast
4	Program Finalization	15 s	Flashing green (number of times a new actuator can be learned)
5	Run Mode ⁽²⁾	—	Steady red

(1) Out of box condition only.
 (2) When teaching an actuator, the switch must be unlocked to insert the actuator. At the completing program finalization, the switch remains unlocked and in the safe state.

IMPORTANT After teaching a new actuator, a power cycle is required to complete the process.

Learn Additional Replacement Actuators

The switch automatically starts a new teach process (Table 1) when a unique coded replacement actuator is inserted in the switch (in the guard closed position).

IMPORTANT When the switch learns a new actuator, it no longer recognizes previously learned actuators.

Lock the Actuator Code

If the actuator is removed from the switch and then reinserted into the switch during the 15-second Program Finalization stage (see Step 4 in Table 1), this action triggers the switch to LOCK the actuator code. This action can be performed during any of the eight unique coded actuator learn cycles.

IMPORTANT After a unique coded actuator is locked using this method, the switch cannot learn additional replacement actuators for the remaining life of the switch. If the actuator is lost or damaged, the switch must be replaced.

Error Codes

The following indicator patterns repeat until a Power Off/On cycle is completed.

Status/Diagnostic Indicator	Error Code
Red-red-red-green	Cannot learn a standard actuator
Red-red-red-green-green	Actuator already learned
Red-red-red-green-green-green	Bad RFID; actuator moved out of range
Red-red-red-green-green-green-green	Exceeded learning eight actuators
Red-red-red-green-green-green-green-green	Unit locked: cannot learn another actuator

Auxiliary Release

Operation of the auxiliary release causes a fault condition.

To reset the switch, cycle the power or issue a RESET command over the link in a GuardLink® safety system.



ATTENTION:

- For infrequent use only. The auxiliary release is not intended for routine access or maintenance. It is intended to be used in exceptional cases only, such as when power is lost and an emergency release is unavailable.
- Do not operate the machine while the auxiliary tool is attached to the switch.
- To help prevent accumulation of debris inside the switch, return the screw that is removed in step 1 immediately after using the auxiliary release tool and tighten the screw to 0.56 N•m (5 lb•in).

Figure 8 - Auxiliary Release Operation— Standard Model [mm (in.)]

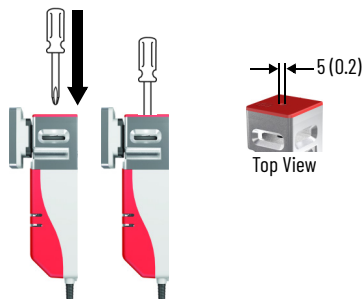
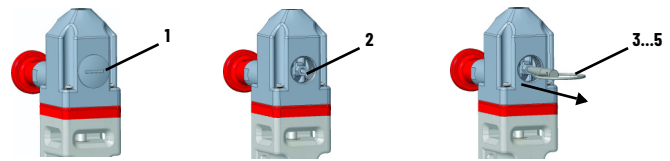

Figure 9 - Auxiliary Release Operation – Escape Release Model [mm (in.)]



Step	Description
1	Remove screw.
2	Engage 2...3 threads of the auxiliary release tool into the release key.
3	Use the tool to pull the release forward to retract the locking bolt.
4	Reset the escape release by pushing the key back to the original position. The actuator can now be removed from the switch. A built-in spring assists with reset of the escape release.
5	Open the guard door. If the guard door does not open, repeat step 3 and step 4.
6	Unscrew the auxiliary release tool and replace the screw that was removed in step 1. Tighten the screw to 0.56 N•m (5 lb•in).

Escape Release

The escape release is used to open a locked safety guard from inside the safe-guarded area without tools.



ATTENTION: Do not remove the M4 screw that seals the opening at the top of the switch.

Figure 10 - Actuate the Escape Release

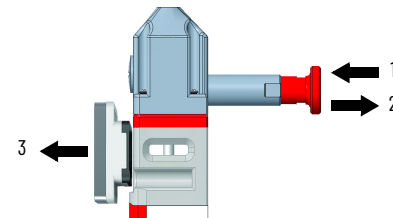

Step	Description
1	Actuate the escape release by pushing the red button to the end stop. This action turns the safety outputs OFF and causes a fault condition.
2	Reset the escape release by pulling out the red button to the original position. The actuator can now be removed from the switch. A built-in spring assists with reset of the escape release.
3	Open the guard door. If the guard door does not open, repeat step 1 and step 2.

- IMPORTANT**
- The escape release meets the requirements of Cat. B according to EN ISO 13849.
 - The escape release must only be accessible from inside the safe-guarded area. The installation must not allow access to the escape release from outside the safe-guarded area.
 - A manual functional test of the escape release is required after installation and after any maintenance or change of components.

Operation of the escape release causes a fault condition. To reset the switch, cycle the power or issue a RESET command over the link in a GuardLink safety system.

Approximate Dimensions

Figure 11 - Switch Body – Standard Model [mm (in.)]

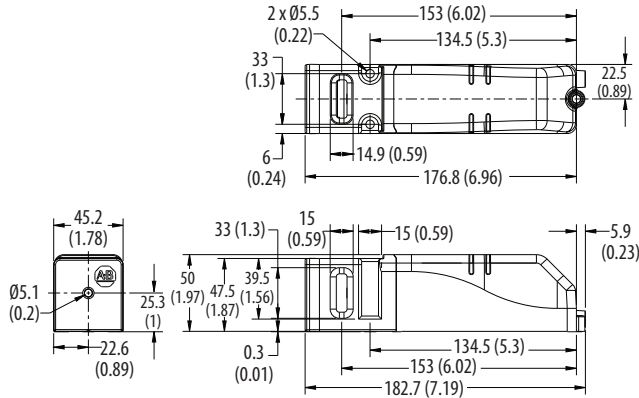

Figure 12 - Switch Body – Escape Release Model [mm (in.)]

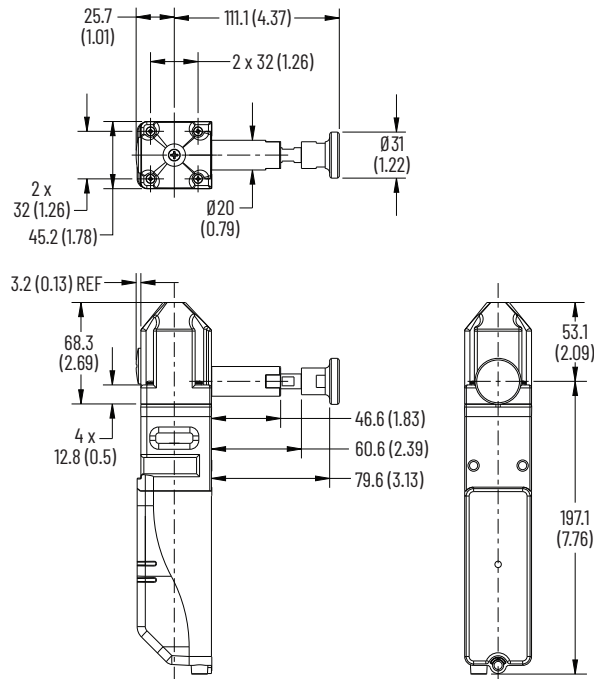
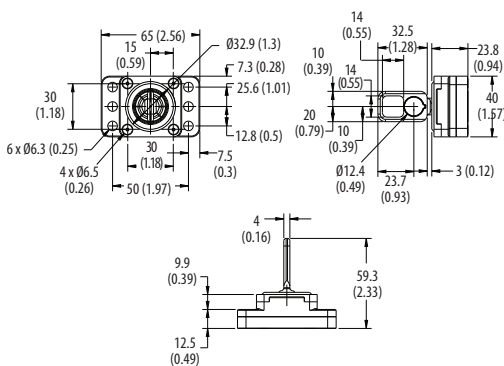

Figure 13 - Actuator [mm (in.)]



Pin Assignment

Table 2 - 5-pin Micro (M12) ⁽¹⁾



Pin	Color	Function	
		OSSD Mode	GuardLink Mode
1	Brown	+24V	+24V
2	White	Safety A	Safety In
3	Blue	0V	0V
4	Black	Safety B	Safety Out
5	Gray	Lock Command	Command, Lock, and Unlock (CLU)

(1) The recommended cordset is Cat. No. 889D-F5AC-2 (2 m [6.5 ft]). For additional lengths, replace the 2 with 5 [5 m (16.4 ft)] or 10 [10 m (32.8 ft)] for standard cable lengths. The recommended patchcord for use with ArmorBlock® Guard Safety I/O is the 2 m (6.5 ft) Cat. No. 889D-F5NCDM-2. Replace the 2 with 0M3 [0.98 ft], 1 [1 m (3.28 ft)], 5 [5 m (16.4 ft)], or 10 [10 m (32.8 ft)] for standard cable lengths.

Connection in a GuardLink System

The 440G-MZ safety switch can be connected to a GuardLink system via a passive tap (catalog number 440S-PF5D shown in Figure 14) or a passive power tap (catalog number 440S-PF5D4).

Figure 14 - Connect 440G-MZ Switch to a GuardLink System with a Passive Tap

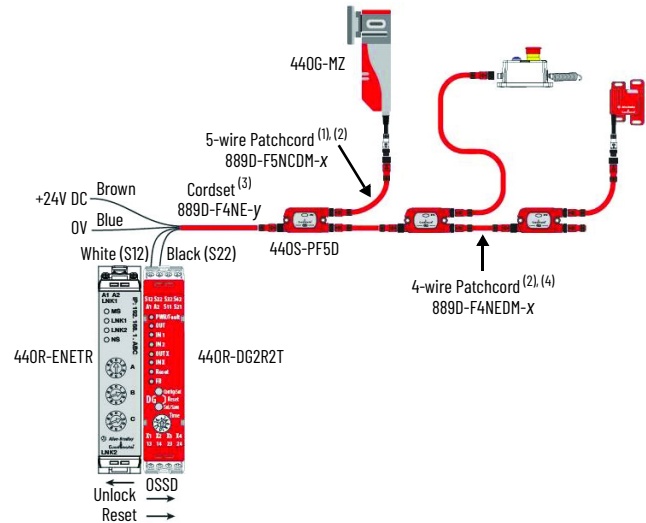

- (1) 10 m (32.8 ft) length, maximum
- (2) Replace x with 0M3 (300 mm [0.98 ft]), 0M6 (600 mm [1.97 ft]), 1 (1 m [3.3 ft]), 2 (2 m [6.6 ft]), 5 (5 m [16.4 ft]), or 10 (10 m [32.8 ft]) for standard cable lengths.
- (3) Replace y in order number with 2 (2 m [6.6 ft]), 5 (5 m [16.4 ft]), 10 (10 m [32.8 ft]), 15 (15 m [49.2 ft]), 20 (20 m [65.6 ft]), or 30 (30 m [98.4 ft]) for standard cable lengths.
- (4) 30 m (98.4 ft) length, maximum

Specifications

Attribute	Value
Standards	IEC 60947-5-3, IEC 61508, ISO 13849-1, IEC 62061, ISO 14119, UL 508
Safety classification	Type 4 interlocking device with guard locking per ISO 14119 with low (standard) and high (unique) coding per ISO 14119 Suitable for use in applications up to and including PLe Cat 4 per ISO 13849-1, SIL CL 3 per IEC 62061, and SIL 3 per IEC 61508.
Functional safety data	OSSD mode ⁽¹⁾ <ul style="list-style-type: none"> • Proof test interval = 20 years • PFHd = 3.17E-09 • PFD = 3.67E-04
	GuardLink® mode ⁽²⁾ <ul style="list-style-type: none"> • Proof test interval = 20 years • PFHd = 2.93E-09 • PFD = 3.59E-04
Certifications	CE Marked for all applicable EU directives, c-UL-us, TÜV

- (1) This data is given for the 440G-MZ safety switch when used in OSSD mode (connected to a safety I/O or safety logic device).
 (2) This data is given for the 440G-MZ safety switch when used in a GuardLink safety system.

Operating Characteristics

Attribute	Value
Torque for M5 mounting of switch and actuator mounting bracket	2 N•m (17.7 lb•in) max
Torque, auxiliary release access screw (escape release model)	0.56 N•m (5 lb•in)
Locking bolt alignment tolerance X, Y, Z	±5 mm (0.2 in.) max
Door radius, min	457.2 mm (18 in.)
Holding force F _{max} (ISO 14119)	3250 N
Holding force F _{zh} (ISO 14119)	2500 N
Output current, max (each output)	200 mA
Quiescent power consumption, locked or unlocked	1.5 W
Lock signal current	1 mA
Peak current and duration, at turn on or after lock/unlock operation	150 mA for approximately 800 ms following lock/unlock operation
Steady state current, max	<ul style="list-style-type: none"> • OSSD mode: 40 mA • GL mode: 50 mA
Operating voltage U _e	24V DC +10% / -15% Class 2 PELV
Operating cycle frequency, max	0.2 Hz
Dwell time between subsequent locking/unlocking	2.5 s
Response time (Off) (IEC 60947-5-3)	275 ms
Start-up time (availability)	8 s
Utilization category (IEC 60947-5-2)	DC-13 24V 200 mA
Insulation voltage U _i (IEC 60947-5-1)	75V
Impulse withstand voltage U _{imp} (IEC 60947-5-1)	1 kV
Pollution degree (IEC 60947-5-1)	3
Auxiliary release	Built in
Escape release	Built-in (select models)
Protection class (IEC 61140)	Class II
Mechanical life	500,000 cycles

Outputs (Guard door is closed and locked)

Attribute	Value
Safety outputs	2 x PNP, 0.2 A max / ON (+24V DC)

Environmental

Attribute	Value
Operating temperature	0...55 °C (32...131 °F)
Storage temperature	-25...+75 °C (-13...+167 °F)
Operating humidity	5...95%, noncondensing
Enclosure ingress rating	<ul style="list-style-type: none"> • IP65 • IP66 • IP67 • IP69 • IP69K
Shock and vibration	<ul style="list-style-type: none"> • IEC 60068-2-27, 30 g (1.1 oz), 11 ms • IEC 60068-2-6, 10...55 Hz, 1 mm (0.4 in.)
Radio frequency/EMC	IEC 60947-5-3, FCC-1 (Parts 18 and 15), RED

General

Attribute	Value	
Materials	Switch	<ul style="list-style-type: none"> • Housing: ABS • Front brace and escape release: SS304 (machined), SS316 (cast)
	Actuator	<ul style="list-style-type: none"> • Housing and housing cover: SS304 • Spring: SS302 • Grommet: nitrile rubber • Screws: stainless steel • Tongue: SS410
	Brackets	High-strength low alloy steel
	Accessories	<ul style="list-style-type: none"> • Padlock: SS410 • Button: Aluminum, powder painted • Auxiliary release tool: SS304 with SS201 key ring • Screw: Steel
Weight [kg (lb)]	<ul style="list-style-type: none"> • Switch: 0.75 (1.7) • Switch with escape release: 1.59 (3.5) • Actuator: 0.27 (0.6) • Actuator L mounting bracket: 0.27 (0.6) • Actuator Z bracket: 0.54 (1.2) • Switch L bracket: 1 (2.2) • Button: 0.025 (0.06) • Auxiliary release tool: 0.018 (0.04) • Screw: 0.014 (0.03) 	
Protection Type	<ul style="list-style-type: none"> • Short-circuit • Current limitation • Overload • Reverse polarity • Overvoltage (up to 60V max) • Thermal shutdown/restart 	

Status Indicators

Table 3 - Output Status and Light-emitting Diode (LED) Indication

Guard Status	Lock Command	Lock Status	Device Indicator ⁽¹⁾	Output Status		State
				OSSD Mode (Safety A and B)	Guardlink Mode (Safety Out)	
Open or Closed	Unlock	Unlocked	Steady red	Off	Off	Safe
Open	Lock	Unlocked	Flashing amber	Off	Off	Ready. Close guard door to lock.
Closed	Lock	Locked	Steady green	On	On	Operational
Open or Closed	Lock or Unlock	Locked or Unlocked	Flashing red	Off	Off	Fault present. Cycle power or issue a RESET command over the link in a Guardlink system ⁽²⁾

- (1) The LINK status indicator is OFF in OSSD mode, and conditional on the status of other devices in Guardlink mode. See publication [440R-UM015](#) in [Additional Resources on page 6](#) for information about the operation of a GuardLink safety system.
 (2) See publication [440G-UM004](#) in [Additional Resources on page 6](#) for more information about diagnostic and fault codes.

Lock Command

Table 4 - Lock Command Function (OSSD mode)







Lock Type	OSSD Mode	Cat. No.
Power to Release	24V = Unlock 0V = Lock	440G-MZS20*NR*
Power to Lock	0V = Unlock 24V = Lock	440G-MZS20*NL*

IMPORTANT In Guardlink mode, LOCK and UNLOCK commands are sent via the GuardLink CLU signal. This function is the same for both Power to Release and Power to Lock models.

Catalog Number Explanation

440G-MZS		20	S	N	R	J	E
		a	b	c	d	e	f
a		b		c			
Outputs (Safety/Auxiliary)		Actuator Code		Auxiliary Type			
Code	Description	Code	Description	Code	Description		
20	Two safety/no aux	S	Standard code	N	No auxiliary		
		U	Unique code				
d		e		f			
Lock Type		Connection Type		Special Features			
Code	Description	Code	Description	Code	Description		
R	Power to Release	J	M12 5-pin	Blank	None		
L	Power to Lock			E	Escape release		

Accessories

Description			Cat. No.
Standard code actuator (Low level to EN ISO 14119)			440G-MZAS
Unique code actuator (High level to EN ISO 14119)			440G-MZAU
	Actuator mounting bracket	L-shaped	440G-MZAM1
		Z-shaped	440G-MZAM2
	Switch mounting bracket		440G-MZAM3
	Padlock accessory		440G-MZAL
	Auxiliary release tool		440G-MZAT
	Replacement screw		440G-MZRSC
	Replacement button		440G-MZRBU

Additional Resources

To download publications, visit rok.auto/literature and search for the following publication numbers.

Resource	Description
440G-MZ Guard Locking Switch User Manual, publication 440G-UM004	Provides general guidelines to install a Rockwell Automation® guard locking switch.
Guardmaster DG Safety Relay and GuardLink System User Manual, publication 440R-UM015	Provides guidelines to configure a Rockwell Automation Guardlink safety system.
Industrial Automation Wiring and Grounding Guidelines, publication 1770-4.1	Provides general guidelines to install a Rockwell Automation industrial system.
Product Certifications website: rok.auto/certifications	Provides declarations of conformity, certificates, and other certification details.

Waste Electrical and Electronic Equipment (WEEE)







At the end of life, this equipment should be collected separately from any unsorted municipal waste.

Rockwell Automation maintains current product environmental compliance information on its website at rok.auto/pec.

Your comments help us serve your documentation needs better. If you have any suggestions on how to improve our content, complete the form at rok.auto/docfeedback.

For technical support, visit rok.auto/support.

Rockwell Otomasyon Ticaret A.Ş. Kar Plaza İş Merkezi E Blok Kat:6 34752, İçerenköy, İstanbul, Tel: +90 (216) 5698400 EEE Yönetmeliğine Uygundur

Connect with us.    

rockwellautomation.com — expanding human possibility®

AMERICAS: Rockwell Automation, 1201 South Second Street, Milwaukee, WI 53204-2496 USA, Tel: (1) 414.382.2000, Fax: (1) 414.382.4444

EUROPE/MIDDLE EAST/AFRICA: Rockwell Automation NV, Pegasus Park, De Kleetlaan 12a, 1831 Diegem, Belgium, Tel: (32) 2 663 0600, Fax: (32) 2 663 0640

ASIA PACIFIC: Rockwell Automation, Level 14, Core F, Cyberport 3, 100 Cyberport Road, Hong Kong, Tel: (852) 2887 4788, Fax: (852) 2508 1846

Allen-Bradley, ArmorBlock, expanding human possibility, GuardLink, Guardmaster, Rockwell Automation, and SensaGuard are trademarks of Rockwell Automation, Inc. Trademarks not belonging to Rockwell Automation are property of their respective companies.

Publication 440G-IN018C-EN-P - September 2021 | Supersedes Publication 440G-IN018B-EN-P - April 2020

Copyright © 2021 Rockwell Automation, Inc. All rights reserved. Printed in the U.S.A.



PN-539600

PN-539600

10005220453 Ver 02