

# LED Work Light PATLED's® User's Manual [ Model : CLK-24 ]

Thank you for purchasing the PATLEDs LED Light Bar for your application. Prior to installation, please read through this manual for proper installation and precautionary steps. In addition, please store this manual for future reference when performing maintenance, repairs or inspections. If you have any questions regarding this product, please contact our PATLITE Sales Representative.

## Safety Precautions

In order to prevent any damage to the user and other personnel or to assets, note the following:

◆ The following symbols classify the following precautions into two categories and explains the level of harm inflicted when caution is disregarded while using this product.

**Warning** Displays the warning "Failure to follow warning may lead to death or severe injury".

**Caution** Displays the warning "Failure to follow caution may lead from light to medium injury or may lead to property loss or injury to others".

◆ The following symbols indicate and explain the nature of the information to be observed.

**Prohibited** This symbol indicates "Prohibited", which should not be carried out by all means.

**Enforced** This symbol indicates "Enforced", which should be observed and carried out by all means.

## 1. For safe application, observe the following:

### Warning

**Prohibited**

- Do not disassemble or modify this product. Failure to comply may result in electric shock or fire.
- After installing this product, be careful not to use this product to climb onto a machine, or to get anything snagged onto this product while it is mounted on equipment, etc. Failure to comply may result in falling off the machinery or product damage may occur.

**Enforced**

- Be sure to disconnect the power when wiring, mounting, exchanging, or repairing the product. Failure to comply may result in damage of the internal circuitry and the danger of electric shock due to short-circuiting.
- Request the installation and wiring to be accompanied by a professional contractor. Failure to comply may result in electric shock, fire, or falling from high places.
- When this product is used for security purposes, it should be inspected daily, and to be used in conjunction with other security products, in case a malfunction should occur.
- Verify the installation location is a firm location which can handle the weight of the product and has no adverse vibrations. If installed in a place where vibration is frequent and/or exceeds the specifications, damage to the product may occur.
- The designated screws should be used for installation. Any parts used that are not specified may result in product damage or personal injury.

### Caution

**Prohibited**

- In order to avoid danger to the eyes, do not stare into the beam, do not view directly into the optical instrument, and don't turn the beam towards someone's eyes. The LED beam is hazardous to the eyes.
- Do not loosen any body screws. It will have an adverse effect on the protection rating.

**Enforced**

- Verify that the specified operating voltage is not exceeded.
- For safety measures, be sure to connect an external fuse to protect from overcurrents or overvoltages from mis-wiring, etc. The product can be protected by short-circuiting due to mis-wiring and overcurrents or overvoltages which can damage it.
- Avoid installation in the following locations:
  - Near space heaters or places where high s are present.
  - In locations where chemical or explosive gasses, etc., are present.

## 2. Model Number Configuration

### 2-1. Model Number Configuration

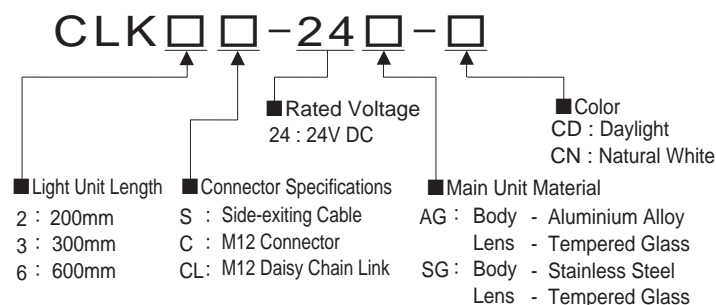

### 2-2. Model List

AG Type	Cable Dims	Standard Bracket Hex Socket Bolt [Qty]
CLK2S-24AG-CD	▲CLK2S-24AG-CN 500mm	1
CLK3S-24AG-CD	CLK3S-24AG-CN 500mm	1
CLK3C-24AG-CD	CLK3C-24AG-CN -	1
CLK3CL-24AG-CD	CLK3CL-24AG-CN -	1
CLK6S-24AG-CD	▲CLK6S-24AG-CN 500mm	2
CLK6C-24AG-CD	CLK6C-24AG-CN -	2
CLK6CL-24AG-CD	CLK6CL-24AG-CN -	2
SG Type	Cable	Bracket
CLK3C-24SG-CD	▲CLK3C-24SG-CN -	0
▲CLK3CL-24SG-CD	▲CLK3CL-24SG-CN -	(Direct Mount)

Models with ▲ in front requires an inquiry before ordering.

● The following is indicated below for the model prefixes

Side-exiting Cable → □S	Body - Aluminium Alloy	Lens - Tempered Glass → AG
M12 Connector → □C	Body - Stainless	Lens - Tempered Glass → SG
M12 Daisy Chain Link → □CL		

### 2-3. Enclosure

CLK□S-24AG-□	Body (Cable with Cable Gland) Standard Bracket, Hex Socket Bolt, User's Manual
CLK□C-24AG-□	Body (with M12 Plug) Standard Bracket, Hex Socket Bolt, User's Manual
CLK□CL-24AG-□	Body (with M12 Plug and Socket) Standard Bracket, Hex Socket Bolt, User's Manual
CLK3C-24SG-CD	Body (with M12 Plug) User's Manual

※ A cable is not attached to models □C · □CL (Common for models AG · SG) Refer to [6. Option Parts] for their applications.

※ For the 600 mm length models, two sets of Standard Brackets with Hex Socket Bolts are included.

## 3. Part Names and Dimensions

### 3-1. Part Names and Dimensions (Unit : mm)

#### AG Type Dimensions [Body - Aluminium Alloy - All Models]

◆ □S (Side-exiting Cable) Series  
→ Cable wire type. This cannot be connected as depicted in section [4-5. Figure 10. □CL Series Wiring Example].

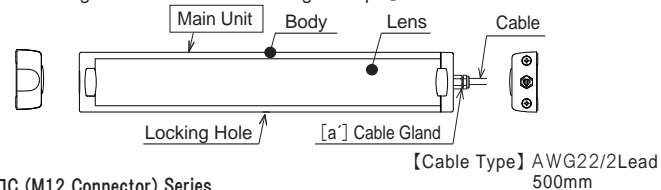

◆ □C (M12 Connector) Series  
→ Power supply can be connected in the M12 connector. When an application requires linking, it is necessary to connect a link terminal connection. [Refer to 4-5. Figure 10. □CL Series Wiring Example]

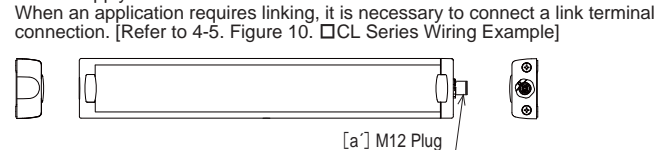

◆ □CL (M12 Daisy Chain Link) Series  
→ It is used to connect between other units by linking them. Use it in conjunction with the □C Series. [Refer to 4-5. Figure 10. □CL Series Wiring Example]

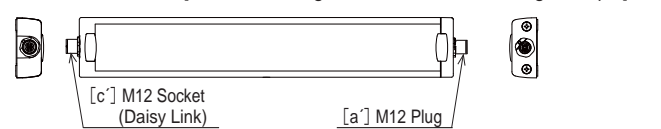

#### AG Type [Common Backplate Parts]

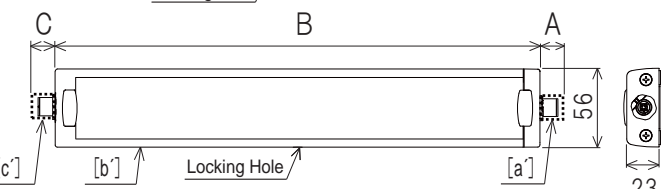
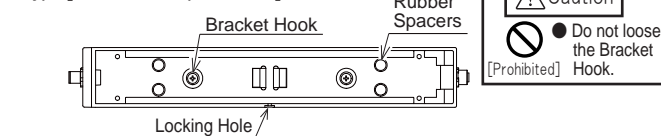

[Table1. Dimensions]

Model	Dimension C	Dimension B	Dimension A
CLK2S-24AG-□	-	250	(15)
CLK3S-24AG-□	-	350	(15)
CLK3C-24AG-□	-	350	(13)
CLK3CL-24AG-□	(12)	350	(13)
CLK6S-24AG-□	-	650	(15)
CLK6C-24AG-□	-	650	(13)
CLK6CL-24AG-□	(12)	650	(13)

### Standard Bracket (AG Type - All Models)

● Specifications for the lens lengths of 200 mm and some 300mm include one Standard Bracket per unit, and for the 600mm lengths, two Standard Bracket sets are included. [Refer to [4-3. Installation for AG Type.]

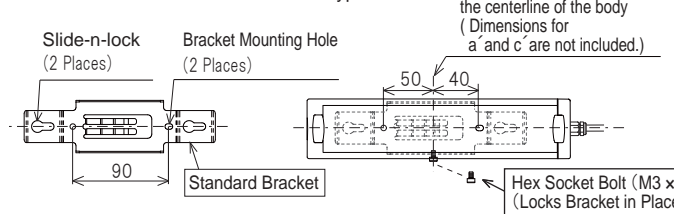
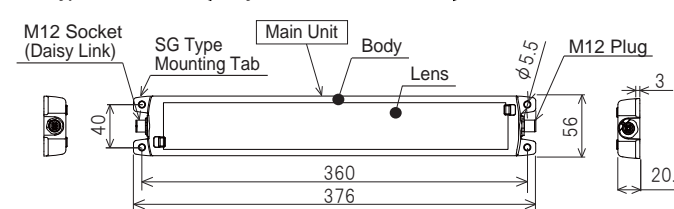

Figure 1. AG Type Installation -1

### SG Type Dimensions [Body- Stainless - All Models]



※ The Standard Bracket is unnecessary. It is for direct mounting.  
※ □CL (M12 Daisy Chain Link) requires an inquiry before ordering.

## 4. Installation

### 4-1. Installation

● Suitable for wet or damp location.

#### Warning

**Prohibited**

- Do not modify or disassemble the product. Failure to comply may result in electric shock or fire.
- After installing this product, be careful not to use this product to climb onto a machine, or to get anything snagged onto this product while it is mounted on equipment, etc. Failure to comply may result in falling off the machinery or product damage may occur.

**Enforced**

- To prevent from electrocution, disconnect power prior to mounting or performing maintenance.
- Verify the installation location is a firm location which can handle the weight of the product and has no adverse vibrations. If installed in a place where vibration is frequent and/or exceeds the specifications, damage to the product may occur.
- The designated screws should be used for installation. Any parts used that are not specified may result in product damage or personal injury.

#### Caution

**Enforced**

- Ensure this product is securely mounted, to prevent from falling, etc.
- This product is for indoor use only. (Not for outdoor use)
- Use protection to secure the standard bracket when mounting in a vertical direction.

### 4-2. Mounting Direction - All CLK-24 Models

● All CLK-24 Models; The attachment direction common to all the models is shown.  
● For the AG Type, beware of the following:  
1. To prevent liquid to accumulate, install with the "Locking Hole" in the downward direction. (When Level)  
2. Mount the Standard Bracket in the direction indicated in the following figures to prevention from falling. (When Vertical)

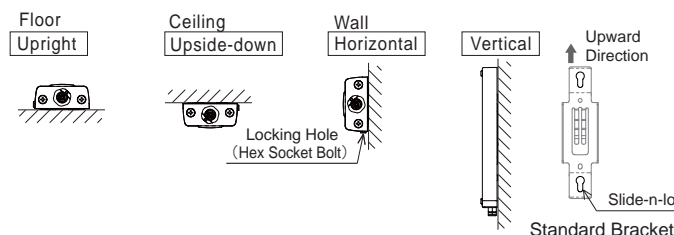

### 4-3. Installation for AG Type

● Specifications for the lens lengths of 200 mm and some 300mm include one Standard Bracket per unit, and for the 600mm lengths, two Standard Bracket sets are included.

Moreover, when sliding the Main Unit onto the Standard Bracket, allow a clearance of at least 12mm on both ends to allow attachment and removal. [Refer to Figure 4. AG Type Slide Installatio -1 and Figure 7. AG Type Slide Installatio -2]

● When connecting several units for the □CL (M12 Daisy Chain Link) Series, be sure to connect the maximum number of links. Refer to [4-5. □CL (M12 Daisy Chain Link) Series Cautionary Notes] to verify the number of links to use.

### Lens Length: 200mm and 300mm (One Standard Bracket per unit included)

① Mounting Hole Dimensions and Standard Bracket Mounting (Recommended)  
Ensure the Standard Bracket is attached to a flat and sturdy surface before making any holes for installation. M5 screw is bolted in the sequence of 1 then 2 (longer hole, first) as shown in the figure below, when the Standard Bracket is fixed into place. The recommended torque for the M5 screw is 2.8 N·m. More importantly, the body cannot be attached if the screw head is larger than 4 mm.

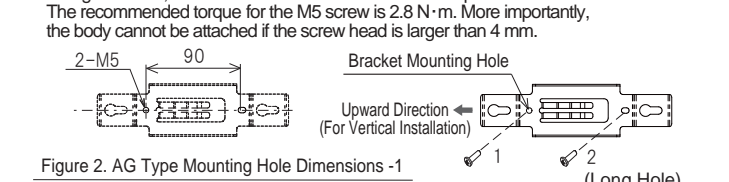

Figure 2. AG Type Mounting Hole Dimensions -1

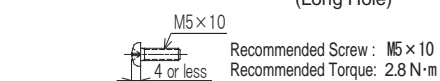

Figure 3. Standard Bracket Mounting

### ② Main Unit Installation

After attaching the Standard Bracket, the Main Unit is attached. Insert the "Bracket Hook" in the back of the Main Unit and insert it into the "Slide-n-lock" holes of the bracket, then slide the Main Unit until the "Locking Hole" of the Main Unit is aligned with the "M3 tapping" for the Standard Bracket.

#### 12mm Slide-n-lock

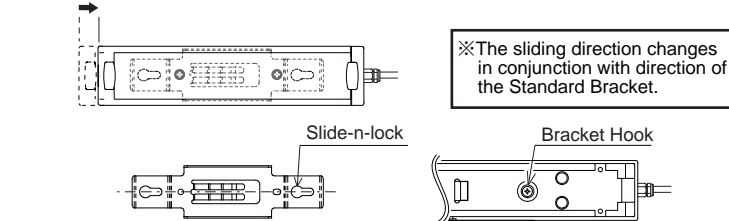

Figure 4. AG Type Slide Installation -1

### ③ Hex Socket Bolt Lock-down

Use the "M3 tapping" Hex Socket Bolt to lock the Standard Bracket into place. This prevents the Body from unattaching from the Standard Bracket. Tighten with a torque of about 0.6N·m.

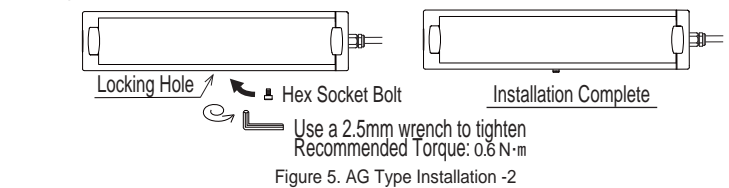

Figure 5. AG Type Installation -2

### Lens Length: 600mm (Two Standard Brackets per unit included)

① Ensure the Standard Bracket is attached to a flat and sturdy surface before making any holes for installation. Using an M5 screw, [Figure 6. AG Type Mounting Hole Dimensions -2] and [Figure 3. Standard Bracket Mounting] to mount in place. Tighten the M5 screw with a torque of about 2.8 N·m.

② After attaching the Standard Bracket, the Body is attached. Insert the "Bracket Hook" in the back of the Main Unit and insert it into the "Slide-n-lock" holes of the bracket, then slide the Main Unit until the "Locking Hole" of the Main Unit is aligned with the "M3 tapping" for the Standard Bracket.

③ Use the "M3 tapping" Hex Socket Bolt to lock the Standard Bracket into place. This prevents the Body from unattaching from the Standard Bracket. Tighten with a torque of about 0.6 N·m.

### ① Mounting Hole Dimensions and Standard Bracket Mounting (Recommended)

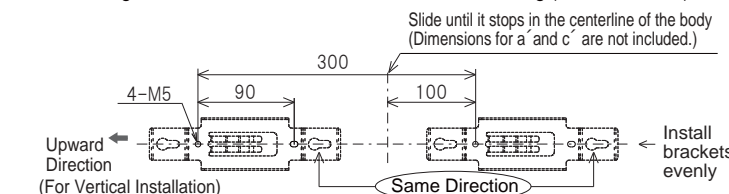

Figure 6. AG Type Mounting Hole Dimensions -2

### ②③ 600mm Main Unit Installation · Hex Socket Bolt Lock-down

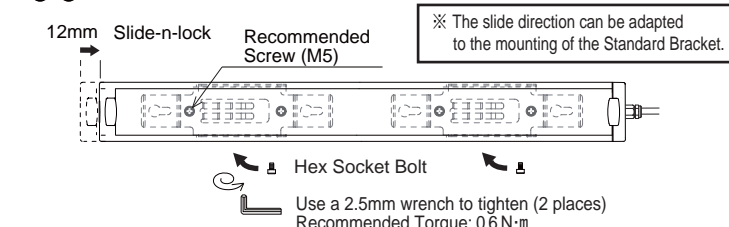

Figure 7. AG Type Slide Installation -2

(Continued on Backside)

#### 4-4. Installation for SG Type (Recommended)

- After tapping the mounting holes to a flat and sturdy surface, use four M5 screws for mounting, as indicated in the following figure. The recommended torque for the M5 screw is 2.8 N·m. [Refer to Figure 9. SG Type Installation]

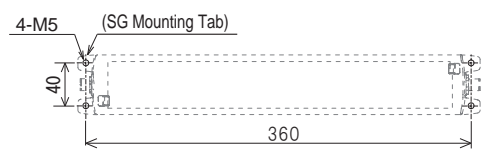
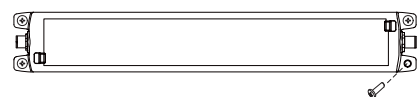

Figure 8. SG Type Mounting Hole Dimensions



Recommended Screw; M5x10  
Recommended Torque; 2.8N·m

Figure 9. SG Type Installation

#### 4-5. □CL (M12 Daisy Chain Link) Series Cautionary Notes

**Caution**

- When linking together, there is a restriction on the maximum number of links. Be sure to use it within the maximum number of links. [Refer to Table 2. Maximum Links] Exceeding the number of maximum links can cause failure.
- Linking this product requires □C (M12 Connector) Series as the terminal link.

- When installing with option parts "M12 link-cable 4-wire 0.6m", or "M12 link-cable 4-wire 0.6m SUS" side-by-side, a gap between the ends of the Body requires a distance from 150mm to 600mm. [Refer to Figure 10. □CL Series Connection Example]

- To the customer; be sure the cable is installed with the distance between products set by the corresponding cable.

※ Refer to 「5-1. Wiring」 for the Daisy Link connection wiring example for the □CL Series.

[Table 2. Maximum Links]

	Terminal Links (per unit)		Daisy Links (connectable units)		Maximum Connections (Units)
	3C	6C	3CL	6CL	
i	1		1 - 4		5
ii	1		1 - 2	0 - 1	4
iii	1			1 - 2	3
iv		1	1 - 3		4
v		1	0 - 1	1	3

※ Refer to 「Table 2. Maximum Links」 for the maximum number of links. Be sure to use maximum number of links as depicted in the figure below. Exceeding the number of maximum links can cause failure.

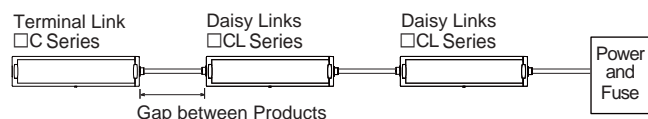

※ When installing with option parts "M12 link-cable 4-wire 0.6m", or "M12 link-cable 4-wire 0.6m SUS" side-by-side, a gap between the ends of the body requires a distance from 150mm to 600mm.

Figure 10. □CL Series Wiring Example

#### 5. Wiring and Proper Use

**Warning**

- Be sure to disconnect the power when wiring, mounting, exchanging, or repairing the product. Failure to comply may result in damage of the internal circuitry and the danger of electric shock due to short-circuiting.

**Caution**

- Check that the proper voltage is connected before applying power.
- Do not pull on the cable, or try to push it inside the unit. Possible cause of failure may occur. In addition, allow a margin of slack for the wire and cable to prevent stress.
- Install a fuse to protect it from the power supply. The product can be protected by short-circuiting due to mis-wiring and overcurrents or overvoltages which can damage it.

- The suitability of the luminaire supply connections shall be determined in the end use product. (□C and □CL Series)

#### 5-1. Wiring

- This product contains a 2A (slow-blow) fuse inside. Use an external fuse rated for the machine, which is connected to the product, to protect the machine from damage.
- Use a UL authenticated Class 2 power supply unit to connect power to this product.

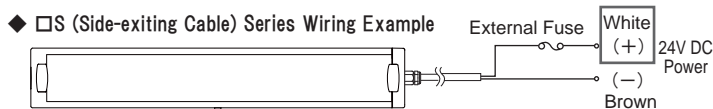

**Caution**

- The protection rating for the side exiting wire (2S, 3S, 6S) does not include the cable ends. If the ends of the cable are in contact with water or exposed to dew or condensation, refer to the indications below to dress the cable ends for water and oil resistance.
  - Connect the wire ends in a location which will not expose the ends to water or oil.
  - Use Fillers, such as silicon, etc., to seal the cable ends.
 Refer to the circled part of the figure below for the sections requiring protection from water and/or oil intrusion.

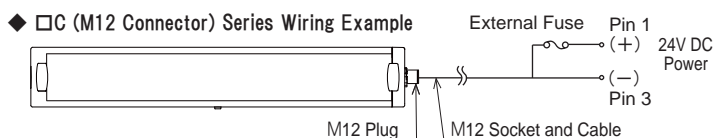

※ When using the optional M12 socket cable "4-wire M12 socket cable-5m" or "4-wire M12 socket cable 5m SUS", the power connections are: Brown (+) / Blue (-).

#### □CL (M12 Daisy Chain Link) Series Wiring Example

- The link terminal for the product should use the □C (M12 Connector) Series.

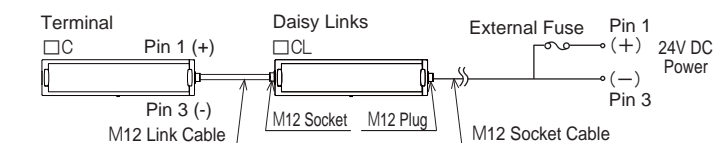

※ When using the optional M12 socket cable "4-wire M12 socket cable-5m" or "4-wire M12 socket cable 5m SUS", the power connections are: Brown (+) / Blue (-).

#### ◇ Link Connection Current Rating

- Calculate the total current by adding the current rating for each link connected. [Refer to 「8. Specification, Rated Current」] Be sure to use maximum number of links as depicted in the figure below. [Refer to 「Table 2. Maximum Links for 4-5. □CL (M12 Daisy Chain Link) Series Cautionary Notes」]

<Example> Refer to the data in 「Table 2. Maximum Link ii」 to look up the current ratings for the following models.  
Terminal Links: 3Cx1 Unit, Daisy Links: 3CLx1 Unit (Maximum 2 units) · 6CLx1 Unit

Terminal Link	Daisy Links		Daisy Link Current Consumption <Example>
3Cx1 unit 522mAx1 unit	+ 3CLx1 unit 522mAx1 unit	+ 6CLx1 unit 1044mAx1 unit	⇒ 2088mA

※ When using the Optional Cable, Daisy Link Current Consumption decreases by a voltage descent.

#### ◆ M12 Connector

□C (M12 Connector) Series and □CL (M12 Daisy Chain Link) Series Wiring

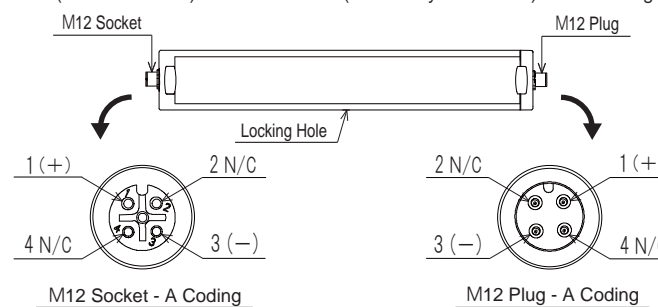

※ The □C (M12 Connector) Series does not include an M12 Socket part.

#### 5-2. Operation

- Referring to section 「5-1. Wiring」 above, by applying 24V DC, the LED will turn on.

#### 6. Option Parts

- This product offers option parts. Visit our homepage for more details.

◆ All AG (Aluminum Body) Models  
"4-wire M12 Socket Cable, 5m length"  
Number: 1536308  
Manufacturer: Phoenix Contact Corp.  
SAC-4P-5,0-PUR/FS SCO

◆ All AG (Aluminum Body) Models  
"4-wire M12 Link Cable, 0.6m length"  
Number: 1518892  
Manufacturer: Phoenix Contact Corp.  
SAC-4P-MS/0,6-PUR/FS SCO

◆ All SG (Stainless Steel Body) Models  
"4-wire M12 SUS Socket Cable, 5m length"  
Number: 1552447  
Manufacturer: Phoenix Contact Corp.  
SAC-4P-5,0-511/M12FS FB

◆ All SG (Stainless Steel Body) Models  
"4-wire M12 SUS Link Cable, 0.6m length"  
Number: 1552638  
Manufacturer: Phoenix Contact Corp.  
SAC-4P-M12MS/0,6-511/M12FS FB

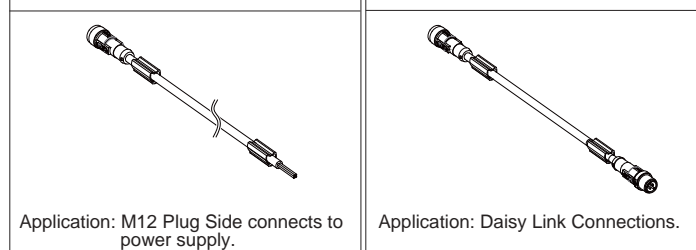

※ All SG (Stainless Steel Body) Models requires an inquiry before ordering "4-wire M12 SUS Link Cable, 0.6m length" option.

#### 7. Maintenance and Inspection

If the product does not work after referring to the table below, please request for repair. In addition, if there are any questions concerning this product, feel free to contact your PATLITE Sales Representative.

Problem	Where to Check	What to Do
Does not light up	Is the power properly supplied?	Verify the voltage has been connected.
		Verify the proper polarity.
		Verify the proper voltage is supplied. (24V DC)
		Verify the external fuse has not been burned-out.

#### 8. Specifications

Model	CLK2S-24		CLK3□-24		CLK6□-24	
	CD	CN	CD	CN	CD	CN
Color Code	Daylight	Natural White	Daylight	Natural White	Daylight	Natural White
Luminous Color	Daylight	Natural White	Daylight	Natural White	Daylight	Natural White
Color Temperature (typ.)	6500 K	5000 K	6500 K	5000 K	6500 K	5000 K
Illuminance (at 24V DC)	1.0m	820 lx	1200 lx	2100 lx		
	2.0m	200 lx	300 lx	580 lx		
Total Luminous Flux	865 lm		1300 lm		2600 lm	
Rated Voltage	24V DC (Polarized)					
Operating Voltage	DC 24V ±10%					
Current Consumption	348 mA ±10%		522 mA ±10%		1044 mA ±10%	
Power Consumption	8.4 W		12.5 W		25 W	
Operating Temperature Range	-40 °C ~ +60 °C (RH90% or less, no condensation)					
Main Unit Material	Body : Aluminum Alloy or Stainless Steel Lens : Tempered Glass or Acrylic Resin					
Protection Rating ※1	IP66G/67G (JIS C0920) / 69K (DIN 40050 part 9) (Cable Connector not included)					
Mounting Location	Indoor					
Mounting Direction	Any Direction					
Insulation Resistance	500V DC 5MΩ or more					
Withstand Voltage	500V AC for 1 minute (Between power terminal and chassis)					
Vibration Resitance	30Hz 19.6 m/s <sup>2</sup>					
	Back and Forth, Up and Down, Left and Right for 2 hrs. each					
Mass ±10%	Aluminum	450 g Standard Bracket : 76 g	600 g Standard Bracket : 76 g	1070 g Standard Bracket : 76 g		
	Stainless	-	SG : 1490 g	-		

※1. Using the Optional Cables.

※ When using the Optional Cable, total current of Link Connection decreases by a voltage descent.

**Note**

- Specifications and dimensions may change without prior notice for improvements, etc.

※ The color tones for the LED may vary and difference in tone for every product may occur due to the characteristics of the LED.  
All protection ratings are the result of testing under controlled conditions and a regulated duration of time. Protection ratings are not guaranteed for a long period of time.

**PATLITE Corporation** G1A

International Division Sales & Marketing Department  
8-8 Matsuya-machi, Chuo-ku, Osaka 542-0067 Japan  
TEL. +81-6-6763-8220  
FAX. +81-6-6763-8221

**PATLITE (U.S.A.) Corporation**  
20130 S. Western Avenue, Torrance, CA 90501 U.S.A.  
TEL. +1-310-328-3222  
FAX. +1-310-328-2676

**PATLITE Europe GmbH**  
Am Soeldnermoos 8, D-85399 Hallbergmoos, Germany  
TEL. +49-811-99819770-0  
FAX. +49-811-99819770-9

**PATLITE (SINGAPORE) PTE LTD**  
No.2 Leng Kee Road, #05-01 Thye Hong Centre, Singapore 159086  
TEL. +65-6226-1111  
FAX. +65-6324-1411

**PATLITE (CHINA) Corporation**  
Room 512, Jufeng Business Building, No.697-3 Lingshi Road, Shanghai 200072, China  
TEL. +86-21-6630-8969  
FAX. +86-21-6630-8938

**PATLITE KOREA CO., LTD.**  
202 Seokwang Bldg. 1361-9 Seocho-dong, Seocho-gu, Seoul, 137-863 Korea  
TEL. +82-2-523-6636  
FAX. +82-2-523-6637

<http://www.patlite.com/>

PATLITE and the PATLITE logo is a trademark, or registered trademark of the PATLITE Corporation of Japan and each country.