

NEW

OMRON

Welding Proximity Sensors

DC 3-Wire Models

E2EW Series

Stable detection
in lines containing both
aluminum and **iron**

Full Metal Body **12** mm
Equivalent sensing distances for iron and aluminum
<M18 quadruple distance models>

Exceptional sensing range*



*Based on December 2019 OMRON investigation.

Catches it all, whether it's iron or aluminum

PREMIUM Models

OMRON's full metal body proximity sensors deliver

Exceptional sensing range

Equivalent sensing distances
for iron and aluminum

12

(M18) P.4 mm

Less design work

Better operation rates

The E2EW Proximity Sensor offers equivalent sensing distances for both iron and aluminum. This means that a common design can be adopted to detect the sitting of both iron and aluminum workpieces in welding processes. It also boasts the exceptional sensing range, which means fewer false detections and thereby fewer unexpected stoppages. It is equipped with a function, which effectively cancels pulse noise of current magnetic field generated during welding.*2

*1. Based on December 2019 OMRON investigation. *2. PREMIUM Models only.

Quadruple distance model

12 mm (M18)

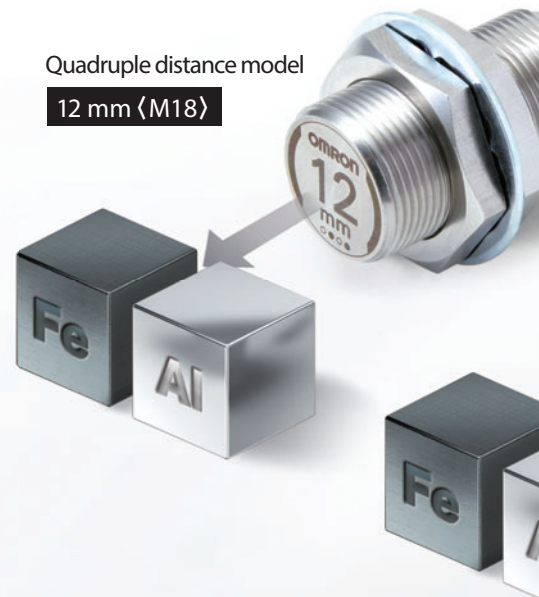

BASIC Models

In addition to our PREMIUM Models, we also offer short-distance BASIC Models to meet various facility design requirement specifications.

Single distance model

5 mm (M18)



*For BASIC Models, the sensing distances for aluminum are approximately one third of those for iron. Refer to the *Engineering Data* on the datasheet.



Triple distance model
10 mm (M18)

New standards for usability

Withstands harsh environments

Lasts 60^{*3} times longer than previous OMRON models

Long-lasting spatter resistance^{*4}



P.6

Durable full metal body

to reduce unexpected stoppages

P.8

Clear status visualization

Detection level and temperature visualization

With IO-Link^{*5}  IO-Link

P.10

All-around detection status visibility

High-brightness LED indicators

P.12

^{*3}. Comparison with E2EF-Q products. Based on June 2019 OMRON investigation.

^{*4}. Models with spatter-resistant coating only.

^{*5}. PREMIUM Models only.

Equivalent sensing distances for iron and aluminum <exceptional sensing range*1 of 12 mm>

Enables facility design with fewer unexpected stoppages even in lines with both iron and aluminum workpieces

*1 Based on December 2019 OMRON investigation. Applies to M18 quadruple distance models.



For both iron and aluminum workpieces

12 mm

E2EW

* M18 quadruple distance models

Iron workpieces	Aluminum workpieces
7 mm	about 2 mm
Previous models	
* M18 models	

Approximately double ^{*2} the sensing distance of previous models
<quadruple distance models>

Exceptional sensing range ^{*3}

Sensing distance comparison

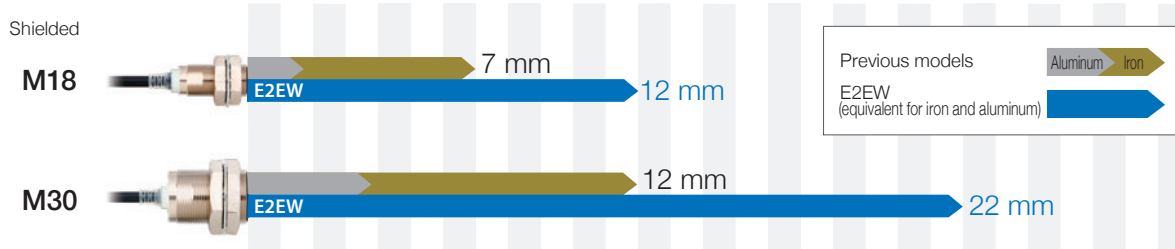

*2. Comparison with E2EF products. *3. Based on December 2019 OMRON investigation.

Less design work

Enables common design for lines with both iron and aluminum

Previously, in order to stably detect sitting in mixed production lines containing both iron and aluminum, facility designs needed to accommodate sensors of different sizes for different sensing distances. With the same sensing distance for iron and aluminum, E2EW Proximity Sensors eliminate the need to change sensors according to workpieces, enabling the standardization of production facilities and mechanical drawings.

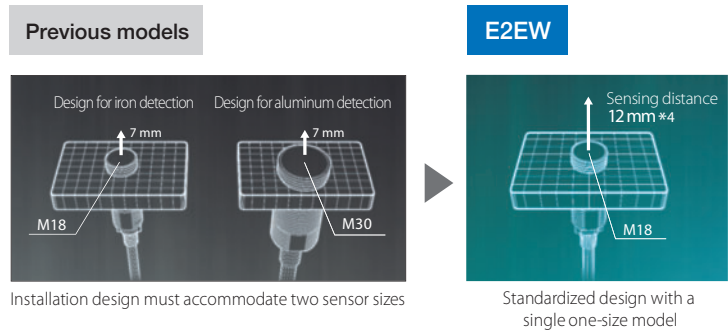

Allows for more spacious sensor installation design

With previous models, to avoid false detections, you were forced to adopt sensor installation designs that risked contact. The E2EW Proximity Sensor, with the exceptional sensing range, can detect accurately from a certain level of distance, which means you can adopt designs with more space to reduce the risk of contact.



*4. Quadruple distance models.

Better operation rates

Reduces unexpected stoppages due to false detections

E2EW Proximity Sensors can detect both iron and aluminum from equally long distances. This longer detection margin means less false detections, even if workpieces are moved from their intended sitting positions. Furthermore, the sensors' installation distances do not need to be strictly adjusted, making them easy for anyone to install.

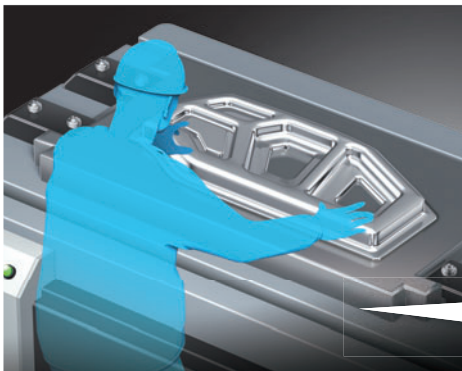

Sitting position confirmation

Previous models

Workpieces not in their exact sitting positions would cause false detections, leading to facility stoppage

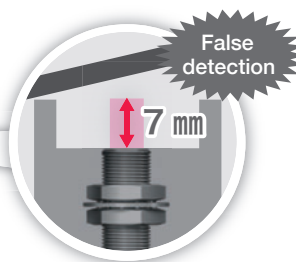

E2EW

Long-distance detection means improved detection margins, enabling stable detection even when a workpiece gets away

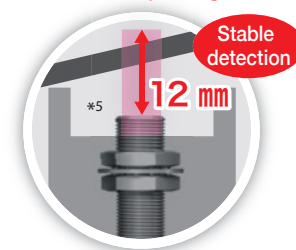

*5. Embeddable triple-distance models are also available. Refer to page17 for details.

Omron's unique technologies provide equivalent long sensing distances for both iron and aluminum

The problem of previous full-metal body proximity sensors was the short sensing distance. E2EW Proximity Sensors are equipped with Omron's unique technology for suppressing noise influence as well as the PRD *6 technology. The technologies reduce the influence of noise, enabling the extended sensing distance. Furthermore, equivalent long distance detection for iron and aluminum is possible by adjusting the timing and time to detect current changes of sensing objects.

Technology for suppressing noise influence Patent Pending *7

Random timing of pulsed current reduces the periodic noise effect on the detection signals.

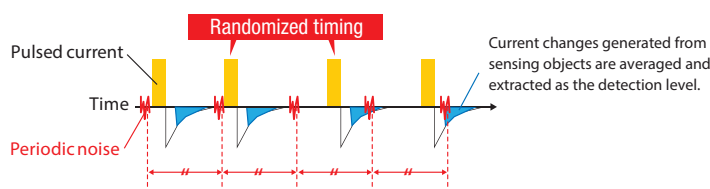

Long sensing distances for both iron and aluminum

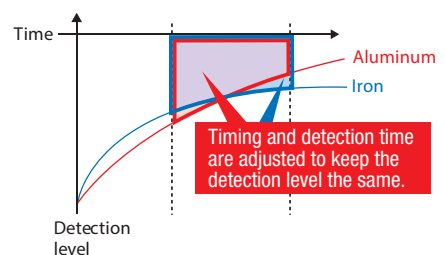

*6. PRD (Pulse Response Detection) is a technology to detect current changes of sensing objects when pulsed currents are applied to coils.

*7. "Patented pending" means that we applied for a patent in Japan, and "Patented" means that we obtained a patent in Japan. (As of June 2019)

New standards for usability Withstands harsh environments

Last 60* times longer than previous OMRON models Long-lasting spatter resistance



OMRON's unique fluororesin coating technologies enable long-lasting spatter resistance.

Less sensor replacements

Abrasion resistant fluororesin coating enables long-lasting spatter resistance against cleaning, allowing for less frequent replacement.

Abrasion resistant coating reduces maintenance work

Previous models ^{*2}

After use ^{*3}

⊕ 40 X zoom with a microscope

Coating comes off quickly even with a spatter-resistant model.

E2EW

After use ^{*3}

Abrasion resistant coating

1/60 ^{*1}
replacement frequency
compared with
previous models

*1. Comparison with E2EF-Q products. Based on June 2019 OMRON investigation. *2. E2EF-Q products. *3. Brush 10 times vertically and horizontally for each maintenance. Repeat 6 times.

Technologies for increasing spatter resistance

Patent Pending ^{*4}

Technologies that can prevent the coating from being worn away during spatter cleanup are key to maintaining spatter resistance over a long period of time. OMRON focused on this point to deliver long-lasting spatter resistance.

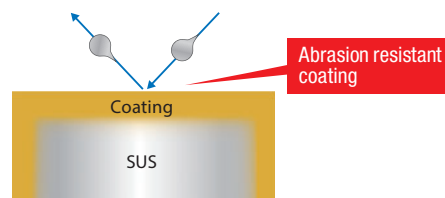

Technologies to prevent coating abrasion

OMRON's unique coating film formation technologies coupled with a specially treated base surface greatly reduces abrasion, to approximately 1/60 of previous models.

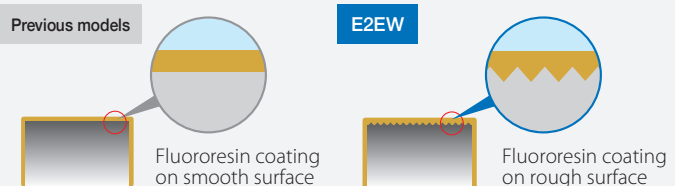

*4. "Patented pending" means that we applied for a patent in Japan, and "Patented" means that we obtained a patent in Japan. (As of June 2019)

New standards for usability Withstands harsh environments

Durable full metal body to reduce unexpected stoppages



PREMIUM Models

BASIC Models

Resistance to friction/collisions with workpieces delivers long service life

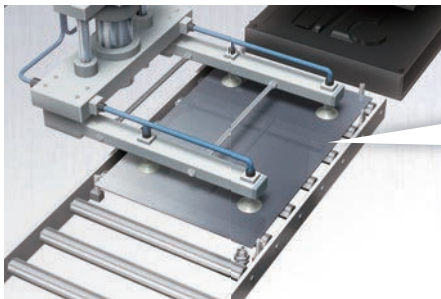

Sitting position detection of metal plates

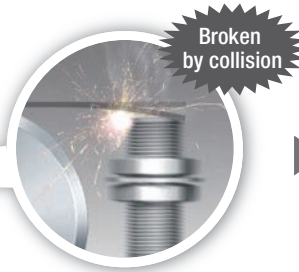

Resin head

Friction/collisions with workpieces causes the sensing surface (head) to wear out, eventually leading to insulation breakdown



E2EW (Full Metal Body)

Exceptional sensing range and thick full metal head eliminate abrasion factors to deliver insulation breakdown resistance

Thick metal head structure

Resistant to friction with workpieces and metal cleaning brushes

In wear resistance tests using stainless-steel brushes rotating at 130 rpm, insulation breakdown occurred in 50 minutes for resin heads, while no insulation breakdown occurred even after 400 minutes for metal heads.



Brush test

*Tests performed on an M18 quadruple distance model (with 0.4 mm sensing surface thickness).

Resin head proximity sensors E2E-X7D1

Initial state → After 50 minutes

Insulation breakdown in 50 minutes

Metal head proximity sensors E2EW-X12□18

Initial state → After 50 minutes → After 400 minutes

No insulation breakdown after 400 minutes

Resistant to workpiece collision



Continuous impact test

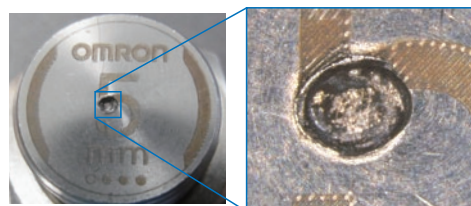

Continuous impact test results showed that the sensing surface was not penetrated even after being impacted 200,000 times. No insulation breakdown occurred.

*Sensing surface thickness varies for different models. Please refer to the datasheet for details.

New standards for usability → Clear status visualization

Detection level and temperature visualization With IO-Link

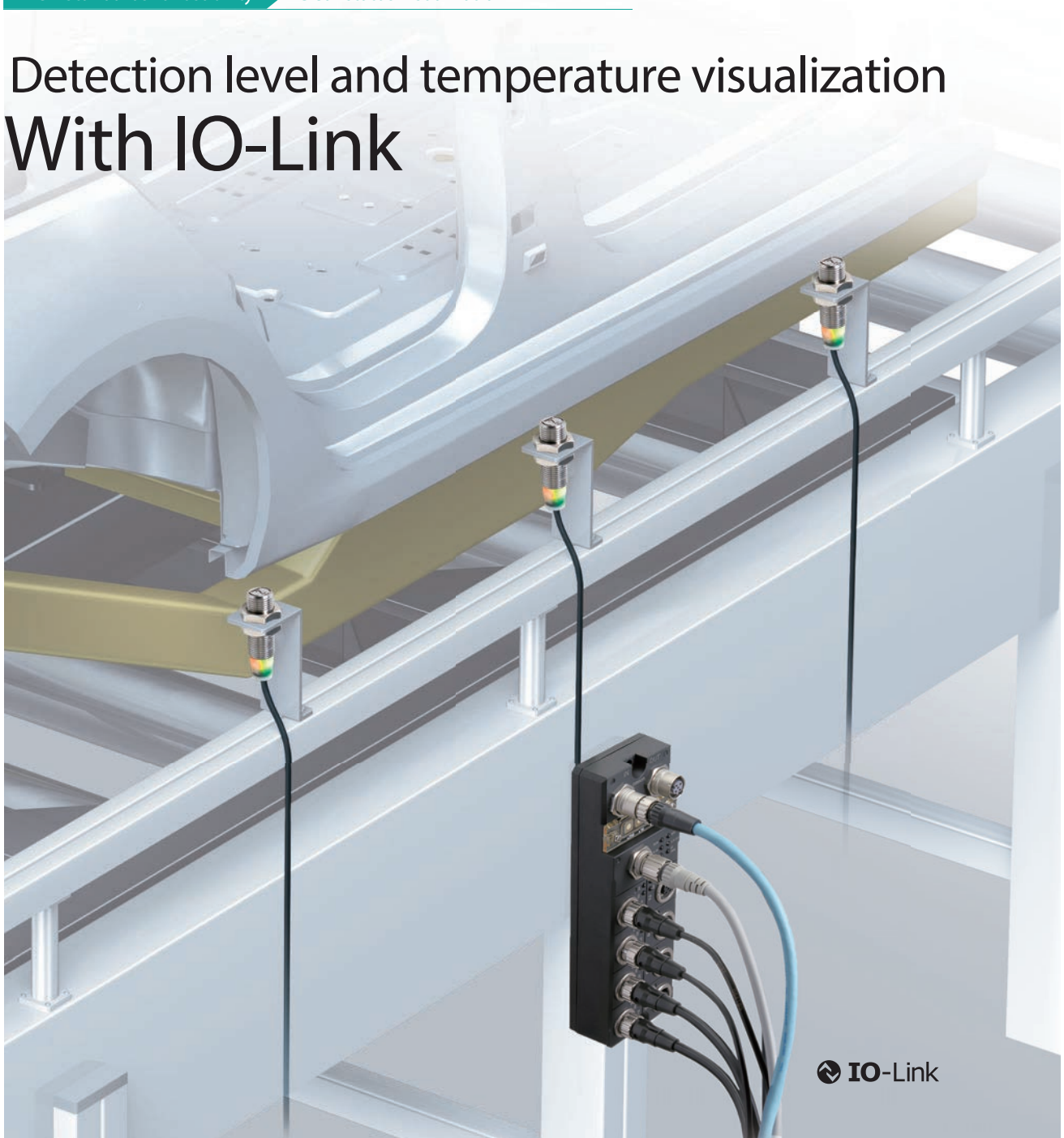

Sensor failures can be detected in 3-wire 2-output (NO+NC) models as well

Enables failure discovery by wiring two outputs, NO and NC

When NO cable is disconnected

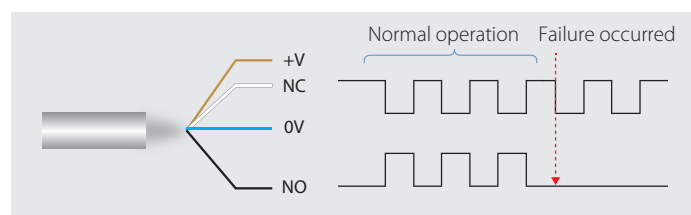

Detection level visualization

A real-time view of how the proximity sensors are detecting objects provides understanding of everyday changes in facility conditions that may not be visible to the naked eye.

*PREMIUM Models only

Application example: Maintenance management based on spatter accumulation

Weld spatter can cause proximity sensors to malfunction. Monitoring detection level changes can allow for timely maintenance.

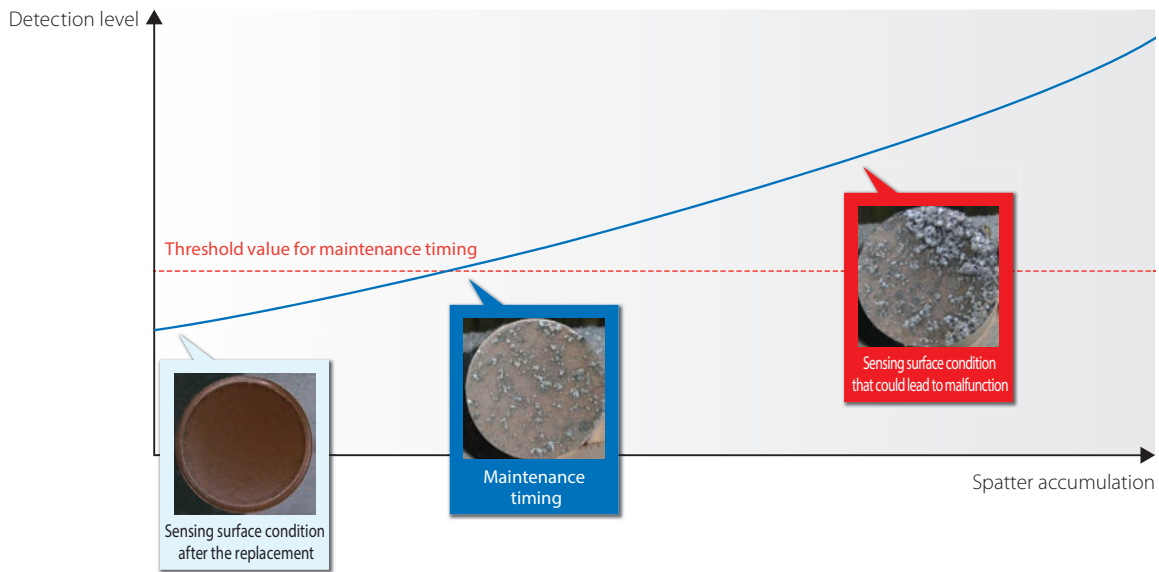

Temperature visualization

Temperature changes in tough environments are visualized in real time, enabling detection of facility malfunction.

Application example: Identifying temperature changes during welding

Proximity sensors installed in multiple sites provide understanding of temperature changes in different locations.

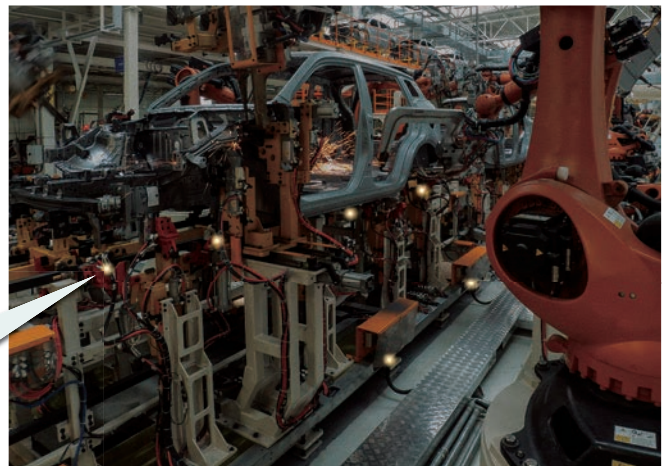
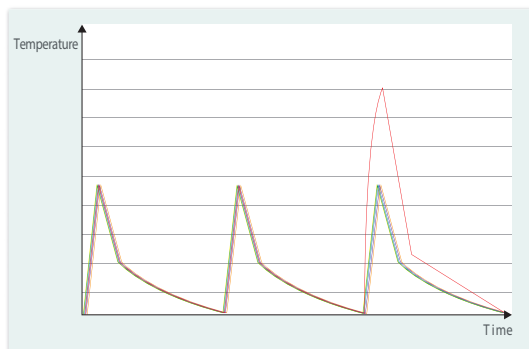

New standards for usability → Clear status visualization

All-around detection status visibility High-brightness LED indicators



High-brightness LEDs provide 360-degree indicator visibility no matter where the sensors are fixed, allowing for speedy installation regardless of sensor orientation. The LEDs also provide easy access to detection status information during operation.

PREMIUM Models

BASIC Models

Other excellent usability reduces maintenance work

Flexible cables to save time and work when replacing and wiring sensors

Wiring can be flexibly routed along the equipment.

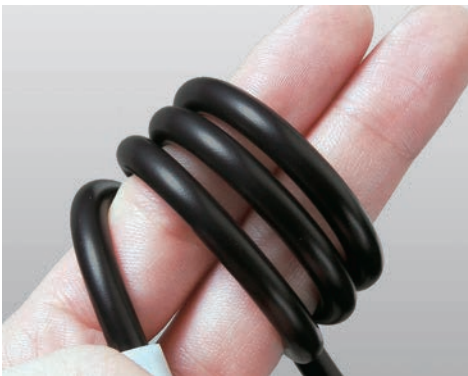

The sensor's sensing distance is printed on its head to prevent replacement errors

The laser printing on the sensor head let you know the sensing distance at glance.

Note: Models without spatter-resistant coating only.



Simplify your inventory to a single model

A customer may currently stock, for example, a total of four models: M18 and M30 models for iron and aluminum, and NO and NC output types for each. The customer now has the option of simplifying their inventory to a single model, the NO+NC 2-output M18 model of the E2EW Proximity Sensor, which meets all these requirements.

This would significantly streamline inventory management and save a great deal of inventory space.

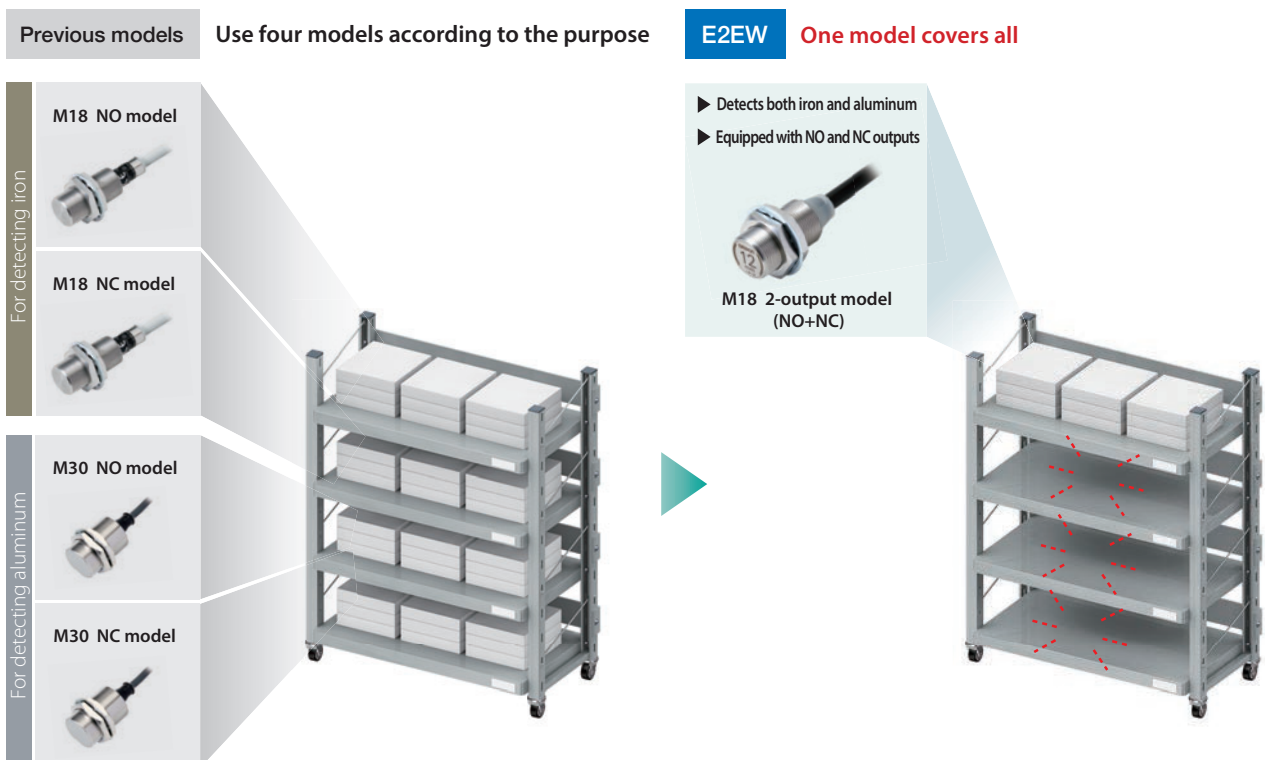

E2EW Series

Selection Guide

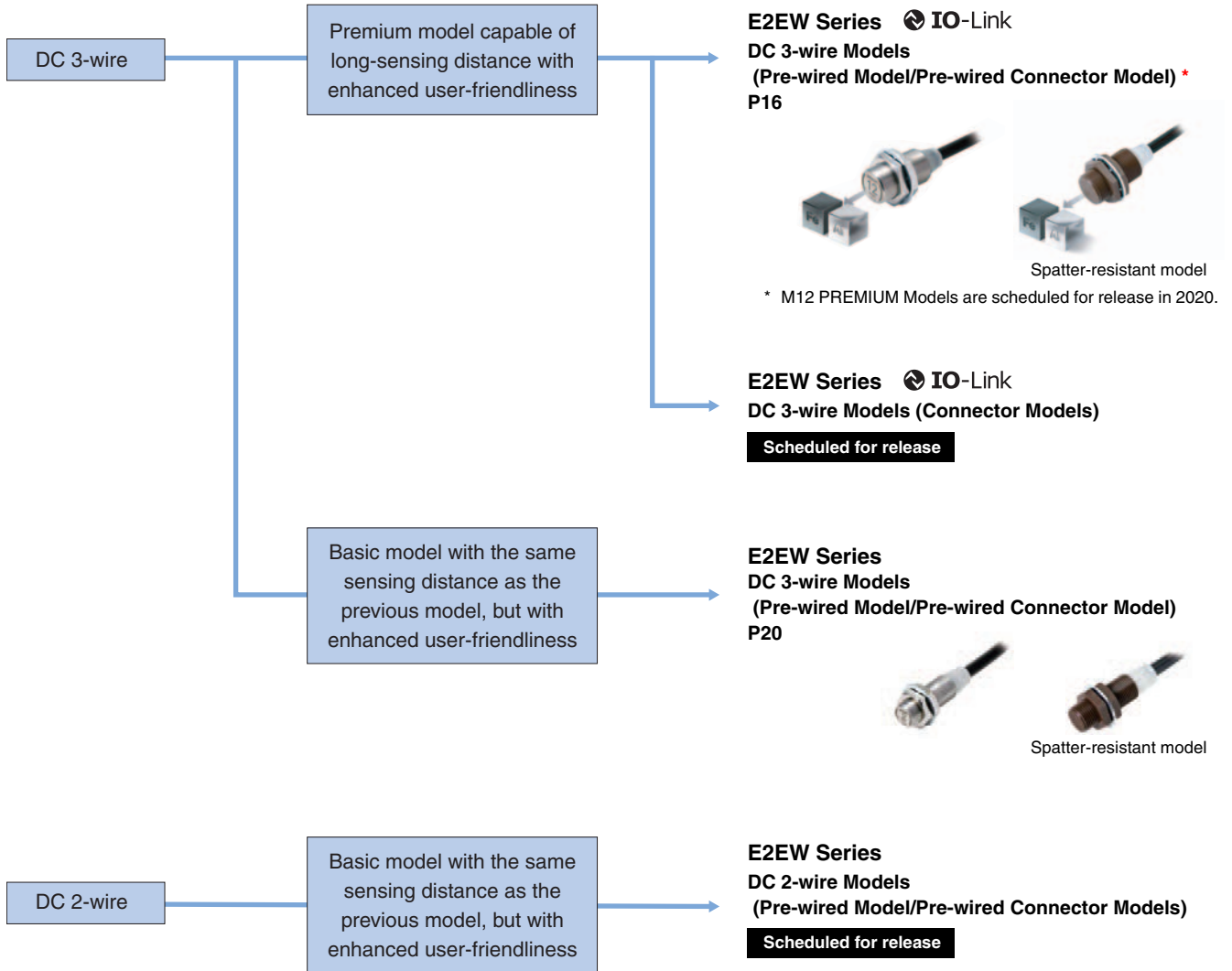

Welding Proximity Sensor E2EW Series

DC 3-wire

Stable detection in lines containing both aluminum and iron

- Equivalent sensing distances for both iron and aluminum *1
- Enables common design for lines with both iron and aluminum *1
- The exceptional sensing range *2, which means fewer false detections and thereby fewer unexpected stoppages.
- OMRON's unique fluororesin coating technologies enable long-lasting spatter resistance *4, which lasts 60 times *3 longer than previous models.
- Durable full metal body to reduce unexpected stoppages
- 2-output (NO+NC) models and models with IO-Link are also available.
- The laser printing on the sensor head let you know the sensing distance at glance. *5
- Equipped with a function, which effectively cancels pulse noise of current magnetic field. *1
- UL certification (UL60947-5-2) and CSA certification (CSA C22.2 UL60947-5-2-14)

*1. PREMIUM Models only.

*2. Based on June 2019 OMRON investigation.

*3. Comparison with E2EF-Q products. Based on June 2019 OMRON investigation.

*4. Models with spatter-resistant coating only.

*5. Models without spatter-resistant coating only.



For the most recent information on models that have been certified for safety standards, refer to your OMRON website.



Be sure to read *Safety Precautions* on page 37.

E2EW Series Model Number Legend

DC 3-wire

E2EW - (1) X (2) (3) (4) (5) (6) - (7) (8)

No.	Type	Code	Meaning
(1)	Case	Blank	Without spatter-resistant coating
		Q	With spatter-resistant coating
(2)	Sensing distance	Number	Sensing distance (Unit: mm)
(3)	Output configuration	B	PNP open collector
		C	NPN open collector
(4)	Operation mode	1	Normally open (NO)
		2	Normally closed (NC)
		3	Normally open, Normally closed (NO+NC)
(5)	IO-Link baud rate	Blank	Non IO-Link compliant
		D	COM2 (38.4kbps)
		T	COM3 (230.4kbps)
(6)	Size	12	M12
		18	M18
		30	M30
(7)	Connection method	Blank	Pre-wired Models
		M1TJ	M12 Pre-wired Smartclick Connector Models
(8)	Cable length	Number M	Cable length

Note: The purpose of this model number legend is to provide understanding of the meaning of specifications from the model number. Models are not available for all combinations of code numbers.

E2EW Series

Ordering Information

PREMIUM Model

E2EW Series (Quadruple distance model)

DC 3-wire [Refer to *Dimensions* on page 40.]

Shielded *1

Size (Sensing distance)	Connection method	Operation mode	Model	
			PNP	NPN
M18 (12 mm)	Pre-wired (2 m) *2	NO	E2EW-X12B1T18 2M	E2EW-X12C118 2M
		NC	E2EW-X12B218 2M	E2EW-X12C218 2M
		NO+NC	E2EW-X12B3T18 2M	---
	M12 Pre-wired Smartclick Connector (0.3 m)	NO	E2EW-X12B1T18-M1TJ 0.3M	E2EW-X12C118-M1TJ 0.3M
		NC	E2EW-X12B218-M1TJ 0.3M	E2EW-X12C218-M1TJ 0.3M
		NO+NC	E2EW-X12B3T18-M1TJ 0.3M	---
M30 (22 mm)	Pre-wired (2 m) *2	NO	E2EW-X22B1T30 2M	E2EW-X22C130 2M
		NC	E2EW-X22B230 2M	E2EW-X22C230 2M
		NO+NC	E2EW-X22B3T30 2M	---
	M12 Pre-wired Smartclick Connector (0.3 m)	NO	E2EW-X22B1T30-M1TJ 0.3M	E2EW-X22C130-M1TJ 0.3M
		NC	E2EW-X22B230-M1TJ 0.3M	E2EW-X22C230-M1TJ 0.3M
		NO+NC	E2EW-X22B3T30-M1TJ 0.3M	---

*1. When embedding the Proximity Sensor in metal, refer to *Influence of Surrounding Metal* on page 38.

*2. Models with 5-m cable length are also available with "5M" suffix. (Example: E2EW-X12B1T18 5M)

Note: 1. Models in are equipped with IO-Link (COM3). For IO-Link (COM2), select a model number with the format of "E2EW-X " (Example: E2EW-X12B1D18 2M).

Operation mode NO can be changed to NC via IO-Link communications.

2. IO-Link is not supported for NC-type PNP outputs or all types of NPN outputs.

PREMIUM Model

E2EW Series (Triple distance model)

DC 3-wire [Refer to *Dimensions* on page 40.]

Shielded *1

Size (Sensing distance)	Connection method	Operation mode	Model	
			PNP	NPN
M18 (10 mm)	Pre-wired (2 m) *2	NO	E2EW-X10B1T18 2M	E2EW-X10C118 2M
		NC	E2EW-X10B218 2M	E2EW-X10C218 2M
		NO+NC	E2EW-X10B3T18 2M	---
	M12 Pre-wired Smartclick Connector (0.3 m)	NO	E2EW-X10B1T18-M1TJ 0.3M	E2EW-X10C118-M1TJ 0.3M
		NC	E2EW-X10B218-M1TJ 0.3M	E2EW-X10C218-M1TJ 0.3M
		NO+NC	E2EW-X10B3T18-M1TJ 0.3M	---
M30 (20 mm)	Pre-wired (2 m) *2	NO	E2EW-X20B1T30 2M	E2EW-X20C130 2M
		NC	E2EW-X20B230 2M	E2EW-X20C230 2M
		NO+NC	E2EW-X20B3T30 2M	---
	M12 Pre-wired Smartclick Connector (0.3 m)	NO	E2EW-X20B1T30-M1TJ 0.3M	E2EW-X20C130-M1TJ 0.3M
		NC	E2EW-X20B230-M1TJ 0.3M	E2EW-X20C230-M1TJ 0.3M
		NO+NC	E2EW-X20B3T30-M1TJ 0.3M	---

*1. When embedding the Proximity Sensor in metal, refer to *Influence of Surrounding Metal* on page 38.

*2. Models with 5-m cable length are also available with "5M" suffix. (Example: E2EW-X10B1T18 5M)

Note: 1. Models in are equipped with IO-Link (COM3). For IO-Link (COM2), select a model number with the format of "E2EW-X□□□D□"
(Example: E2EW-X10B1D18 2M).

Operation mode NO can be changed to NC via IO-Link communications.

2. IO-Link is not supported for NC-type PNP outputs or all types of NPN outputs.

E2EW Series

PREMIUM Model

E2EW-Q Series (Spatter-resistant Quadruple distance model)

DC 3-wire [Refer to *Dimensions* on page 40.]

Shielded *1

Size (Sensing distance)	Connection method	Operation mode	Model	
			PNP	NPN
M18 (12 mm)	Pre-wired (2 m) *2	NO	E2EW-QX12B1T18 2M	E2EW-QX12C118 2M
		NC	E2EW-QX12B218 2M	E2EW-QX12C218 2M
		NO+NC	E2EW-QX12B3T18 2M	---
	M12 Pre-wired Smartclick Connector (0.3 m)	NO	E2EW-QX12B1T18-M1TJ 0.3M	E2EW-QX12C118-M1TJ 0.3M
		NC	E2EW-QX12B218-M1TJ 0.3M	E2EW-QX12C218-M1TJ 0.3M
		NO+NC	E2EW-QX12B3T18-M1TJ 0.3M	---
M30 (22 mm)	Pre-wired (2 m) *2	NO	E2EW-QX22B1T30 2M	E2EW-QX22C130 2M
		NC	E2EW-QX22B230 2M	E2EW-QX22C230 2M
		NO+NC	E2EW-QX22B3T30 2M	---
	M12 Pre-wired Smartclick Connector (0.3 m)	NO	E2EW-QX22B1T30-M1TJ 0.3M	E2EW-QX22C130-M1TJ 0.3M
		NC	E2EW-QX22B230-M1TJ 0.3M	E2EW-QX22C230-M1TJ 0.3M
		NO+NC	E2EW-QX22B3T30-M1TJ 0.3M	---

*1. When embedding the Proximity Sensor in metal, refer to *Influence of Surrounding Metal* on page 38.

*2. Models with 5-m cable length are also available with "5M" suffix. (Example: E2EW-QX12B1T18 5M)

Note: 1. Models in are equipped with IO-Link (COM3). For IO-Link (COM2), select a model number with the format of "E2EW-QX□□□□□□"
(Example: E2EW-QX12B1D18 2M).

Operation mode NO can be changed to NC via IO-Link communications.

2. IO-Link is not supported for NC-type PNP outputs or all types of NPN outputs.

PREMIUM Model

E2EW-Q Series (Spatter-resistant Triple distance model)

DC 3-wire [Refer to *Dimensions* on page 40.]

Shielded *1

Size (Sensing distance)	Connection method	Operation mode	Model	
			PNP	NPN
M18 (10 mm)	Pre-wired (2 m) *2	NO	E2EW-QX10B1T18 2M	E2EW-QX10C118 2M
		NC	E2EW-QX10B218 2M	E2EW-QX10C218 2M
		NO+NC	E2EW-QX10B3T18 2M	---
	M12 Pre-wired Smartclick Connector (0.3 m)	NO	E2EW-QX10B1T18-M1TJ 0.3M	E2EW-QX10C118-M1TJ 0.3M
		NC	E2EW-QX10B218-M1TJ 0.3M	E2EW-QX10C218-M1TJ 0.3M
		NO+NC	E2EW-QX10B3T18-M1TJ 0.3M	---
M30 (20 mm)	Pre-wired (2 m) *2	NO	E2EW-QX20B1T30 2M	E2EW-QX20C130 2M
		NC	E2EW-QX20B230 2M	E2EW-QX20C230 2M
		NO+NC	E2EW-QX20B3T30 2M	---
	M12 Pre-wired Smartclick Connector (0.3 m)	NO	E2EW-QX20B1T30-M1TJ 0.3M	E2EW-QX20C130-M1TJ 0.3M
		NC	E2EW-QX20B230-M1TJ 0.3M	E2EW-QX20C230-M1TJ 0.3M
		NO+NC	E2EW-QX20B3T30-M1TJ 0.3M	---

*1. When embedding the Proximity Sensor in metal, refer to *Influence of Surrounding Metal* on page 38.

*2. Models with 5-m cable length are also available with "5M" suffix. (Example: E2EW-QX10B1T18 5M)

Note: 1. Models in are equipped with IO-Link (COM3). For IO-Link (COM2), select a model number with the format of "E2EW-QX " (Example: E2EW-QX10B1D18 2M).

Operation mode NO can be changed to NC via IO-Link communications.

2. IO-Link is not supported for NC-type PNP outputs or all types of NPN outputs.

E2EW Series

BASIC Model

E2EW Series (Single distance model)

DC 3-wire [Refer to *Dimensions* on page 40.]

Shielded

Size (Sensing distance)	Connection method	Operation mode	Model	
			PNP	NPN
M12 (2 mm)	Pre-wired (2 m) *	NO	E2EW-X2B112 2M	E2EW-X2C112 2M
		NC	E2EW-X2B212 2M	E2EW-X2C212 2M
		NO+NC	E2EW-X2B312 2M	E2EW-X2C312 2M
	M12 Pre-wired Smartclick Connector (0.3 m)	NO	E2EW-X2B112-M1TJ 0.3M	E2EW-X2C112-M1TJ 0.3M
		NC	E2EW-X2B212-M1TJ 0.3M	E2EW-X2C212-M1TJ 0.3M
		NO+NC	E2EW-X2B312-M1TJ 0.3M	E2EW-X2C312-M1TJ 0.3M
M18 (5 mm)	Pre-wired (2 m) *	NO	E2EW-X5B118 2M	E2EW-X5C118 2M
		NC	E2EW-X5B218 2M	E2EW-X5C218 2M
		NO+NC	E2EW-X5B318 2M	E2EW-X5C318 2M
	M18 Pre-wired Smartclick Connector (0.3 m)	NO	E2EW-X5B118-M1TJ 0.3M	E2EW-X5C118-M1TJ 0.3M
		NC	E2EW-X5B218-M1TJ 0.3M	E2EW-X5C218-M1TJ 0.3M
		NO+NC	E2EW-X5B318-M1TJ 0.3M	E2EW-X5C318-M1TJ 0.3M
M30 (10 mm)	Pre-wired (2 m) *	NO	E2EW-X10B130 2M	E2EW-X10C130 2M
		NC	E2EW-X10B230 2M	E2EW-X10C230 2M
		NO+NC	E2EW-X10B330 2M	E2EW-X10C330 2M
	M30 Pre-wired Smartclick Connector (0.3 m)	NO	E2EW-X10B130-M1TJ 0.3M	E2EW-X10C130-M1TJ 0.3M
		NC	E2EW-X10B230-M1TJ 0.3M	E2EW-X10C230-M1TJ 0.3M
		NO+NC	E2EW-X10B330-M1TJ 0.3M	E2EW-X10C330-M1TJ 0.3M

* Models with 5-m cable length are also available with "5M" suffix. (Example: E2EW-X2B112 5M)

Note: IO-Link is not supported for all types of BASIC Model.

BASIC Model

E2EW-Q Series (Spatter-resistant Single distance model)

DC 3-wire [Refer to *Dimensions* on page 40.]

Shielded

Size (Sensing distance)	Connection method	Operation mode	Model	
			PNP	NPN
M12 (2 mm)	Pre-wired (2 m) *	NO	E2EW-QX2B112 2M	E2EW-QX2C112 2M
		NC	E2EW-QX2B212 2M	E2EW-QX2C212 2M
		NO+NC	E2EW-QX2B312 2M	E2EW-QX2C312 2M
	M12 Pre-wired Smartclick Connector (0.3 m)	NO	E2EW-QX2B112-M1TJ 0.3M	E2EW-QX2C112-M1TJ 0.3M
		NC	E2EW-QX2B212-M1TJ 0.3M	E2EW-QX2C212-M1TJ 0.3M
		NO+NC	E2EW-QX2B312-M1TJ 0.3M	E2EW-QX2C312-M1TJ 0.3M
M18 (5 mm)	Pre-wired (2 m) *	NO	E2EW-QX5B118 2M	E2EW-QX5C118 2M
		NC	E2EW-QX5B218 2M	E2EW-QX5C218 2M
		NO+NC	E2EW-QX5B318 2M	E2EW-QX5C318 2M
	M12 Pre-wired Smartclick Connector (0.3 m)	NO	E2EW-QX5B118-M1TJ 0.3M	E2EW-QX5C118-M1TJ 0.3M
		NC	E2EW-QX5B218-M1TJ 0.3M	E2EW-QX5C218-M1TJ 0.3M
		NO+NC	E2EW-QX5B318-M1TJ 0.3M	E2EW-QX5C318-M1TJ 0.3M
M30 (10 mm)	Pre-wired (2 m) *	NO	E2EW-QX10B130 2M	E2EW-QX10C130 2M
		NC	E2EW-QX10B230 2M	E2EW-QX10C230 2M
		NO+NC	E2EW-QX10B330 2M	E2EW-QX10C330 2M
	M12 Pre-wired Smartclick Connector (0.3 m)	NO	E2EW-QX10B130-M1TJ 0.3M	E2EW-QX10C130-M1TJ 0.3M
		NC	E2EW-QX10B230-M1TJ 0.3M	E2EW-QX10C230-M1TJ 0.3M
		NO+NC	E2EW-QX10B330-M1TJ 0.3M	E2EW-QX10C330-M1TJ 0.3M

* Models with 5-m cable length are also available with "5M" suffix. (Example: E2EW-QX2B112 5M)



Note: IO-Link is not supported for all types of BASIC Model.

Accessories (Sold Separately)

Sensor I/O Connectors

(Models for Pre-wired Connectors) A Sensor I/O Connector is not provided with the Sensor. It must be ordered separately as required.

Round Water-resistant Connectors XS5 series

Appearance	Cable Specification	Type	Cable diameter (mm)	Cable Connection Direction	Cable length (m)	Sensor I/O Connector model number	Applicable Proximity Sensor model number	
M12 Smartclick Connector Straight type  Right-angle type 	PVC robot cable	Sockets on One Cable End	6 dia.	Straight	1	XS5F-D421-C80-F	E2EW-X□□□-M1TJ E2EW-QX□□□-M1TJ	
					2	XS5F-D421-D80-F		
					3	XS5F-D421-E80-F		
					5	XS5F-D421-G80-F		
					10	XS5F-D421-J80-F		
				Right-angle	1	XS5F-D422-C80-F		
					2	XS5F-D422-D80-F		
					3	XS5F-D422-E80-F		
					5	XS5F-D422-G80-F		
					10	XS5F-D422-J80-F		
		Socket and Plug on Cable Ends	6 dia.	Straight (Socket)/ Straight (Plug)	1	XS5W-D421-C81-F		
					2	XS5W-D421-D81-F		
					3	XS5W-D421-E81-F		
					5	XS5W-D421-G81-F		
				Right-angle (Socket)/ Right-angle (Plug)	2	XS5W-D422-D81-F		
					5	XS5W-D422-G81-F		
					Straight (Socket)/ Right-angle (Plug)	2		XS5W-D423-D81-F
						5		XS5W-D423-G81-F
Right-angle (Socket)/ Straight (Plug)	2	XS5W-D424-D81-F						
	5	XS5W-D424-G81-F						

Note: For details of the connector, refer to *XS5 Series* on page 42.

Ratings and Specifications

PREMIUM Model

E2EW Series (Quadruple/Triple distance model)

E2EW-Q Series (Spatter-resistant Quadruple/Triple distance model)

DC 3-wire

Shielded

Item	Type Size Model	Quadruple distance model		Triple distance model	
		M18	M30	M18	M30
		E2EW-(Q)X12□18	E2EW-(Q)X22□30	E2EW-(Q)X10□18	E2EW-(Q)X20□30
Sensing distance		12 mm ±10%	22 mm ±10%	10 mm ±10%	20 mm ±10%
Setting distance		0 to 8.4 mm	0 to 15.4 mm	0 to 7.0 mm	0 to 14 mm
Differential travel		15% max. of sensing distance			
Detectable object		Ferrous metals and non-ferrous metals (The sensing distance depends on the material of the sensing object. Refer to <i>Engineering Data</i> on page 25.)			
Standard sensing object		Iron, 36 × 36 × 1 mm	Iron, 66 × 66 × 1 mm	Iron, 30 × 30 × 1 mm	Iron, 60 × 60 × 1 mm
Response frequency *1 *2		2 Hz			
Power supply voltage		10 to 30 VDC (including 10% ripple (p-p)), Class 2			
Current consumption		720 mW max. (Current consumption: 30 mA max. at power supply voltage of 24 V)			
Output configuration		B□ Models: PNP open collector, C□ Models: NPN open collector			
Operation mode		1-output models (B1, C1): NO (Normally open), 1-output models (B2, C2): NC (Normally closed), 2-output models (B3): NO+NC (Normally open, Normally closed)			
Control output	Load current	1-output models (B1,B2,C1,C2): 10 to 30 VDC, Class 2, 200 mA max. 2-output models (B3): 10 to 30 VDC, Class 2, 100 mA max.			
	Residual voltage	1-output models (B1,B2,C1,C2): 2 V max. (Load current: 200 mA, Cable length: 2 m) 2-output models (B3): 2 V max. (Load current: 100 mA, Cable length: 2 m)			
Indicator		In the Standard I/O mode (SIO mode): Operation indicator (orange, lit) and communication indicator (green, not lit) In the IO-Link communication mode (COM mode): Operation indicator (orange, lit) and communication indicator (green, blinking at 1 s intervals)			
Protection circuits		Power supply reverse polarity protection, Surge suppressor, Output short-circuit protection, Output reverse polarity protection			
Ambient temperature range		Operating: 0 to 85 °C, Storage: -15 to 85 °C (with no icing or condensation) *4			
Ambient humidity range		Operating/Storage: 35% to 95% (with no condensation)			
Temperature influence		±20% max. of sensing distance at 23 °C in the temperature range of 0 to 85 °C			
Voltage influence		±1.5% max. of sensing distance at rated voltage in the rated voltage ±15% range			
Insulation resistance		50 MΩ min. (at 500 VDC) between current-carrying parts and case			
Dielectric strength		1,000 VAC, 50/60 Hz for 1 minute between current-carrying parts and case			
Vibration resistance (destruction)		10 to 55 Hz, 1.5-mm double amplitude for 2 hours each in X, Y, and Z directions			
Shock resistance (destruction)		1,000 m/s ² 10 times each in X, Y, and Z directions			
Degree of protection		IEC 60529: IP67			
Connection method		Pre-wired Models (Standard cable length: 2 m), Pre-wired Connector Models (Standard cable length: 0.3 m)			
Weight (packed state)	Pre-wired	Approx. 165 g	Approx. 225 g	Approx. 165 g	Approx. 225 g
	M12 Pre-wired Smartclick Connector	Approx. 100 g	Approx. 160 g	Approx. 100 g	Approx. 160 g
Materials	Case	E2EW-X□: Stainless steel (SUS303), E2EW-QX□: Fluororesin coating (Base material: (SUS303))			
	Sensing surface	E2EW-X□: Stainless steel (SUS303), E2EW-QX□: Fluororesin coating (Base material: (SUS303))			
	Sensing surface (Thickness)	0.4 mm	0.5 mm	0.4 mm	0.5 mm
	Clamping nuts	E2EW-X□: Stainless steel (SUS303), E2EW-QX□: Fluororesin coating (Base material: (SUS303))			
	Toothed washers	Zinc-plated iron			
Cable	Vinyl chloride (PVC)				
Main IO-Link functions *3		Operation mode switching between NO and NC, self diagnosis enabling, excessive proximity judgment distance selecting, timer function of the control output and timer time selecting, instability output (IO-Link mode) ON delay timer time selecting function, monitor output, operating hours read-out, readout of the sensor internal temperature, and initial reset			
IO-Link Communication specifications *3	IO-Link specification	Ver.1.1			
	Baud rate	E2EW-(Q) X□B□T□: COM3 (230.4 kbps), E2EW-(Q) X□B□D□: COM2 (38.4 kbps)			
	Data length	PD size: 2 bytes, OD size: 1 byte (M-sequence type: TYPE_2_2)			
	Minimum cycle time	COM2: 2.3 ms, COM3: 1.0 ms			
Accessories		Instruction manual, Clamping nuts, Toothed washer			

*1. The response frequency is an average value.

*2. Factory setting: (timer function: ONOFF delay, timer time: 200 ms)

*3. IO-Link is not supported for NC-type PNP outputs or all types of NPN outputs.

*4. UL temperature rating is between 0 °C to 60 °C.

E2EW Series

BASIC Model

E2EW Series (Single distance model)

E2EW-Q Series (Spatter-resistant Single distance model)

DC 3-wire

Shielded

Item	Type Size Model	Single distance model		
		M12	M18	M30
		E2EW-(Q)X2□12	E2EW-(Q)X5□18	E2EW-(Q)X10□30
Sensing distance		2 mm ±10%	5 mm ±10%	10 mm ±10%
Setting distance		0 to 1.4 mm	0 to 3.5 mm	0 to 7 mm
Differential travel		10% max. of sensing distance		
Detectable object		Ferrous metals and non-ferrous metals (The sensing distance depends on the material of the sensing object. Refer to <i>Engineering Data</i> on page 25.)		
Standard sensing object		Iron, 12 × 12 × 1 mm	Iron, 18 × 18 × 1 mm	Iron, 30 × 30 × 1 mm
Response frequency *1		100 Hz	80 Hz	40 Hz
Power supply voltage		10 to 30 VDC (including 10% ripple (p-p)), Class 2		
Current consumption		1-output models (B1, B2, C1, C2): 16 mA max. 2-output models (B3, C3): 20 mA max.		
Output configuration		B□ Models: PNP open collector, C□ Models: NPN open collector		
Operation mode		1-output models (B1, C1): NO (Normally open), 1-output models (B2, C2): NC (Normally closed), 2-output models (B3, C3): NO+NC (Normally open, Normally closed)		
Control output	Load current	1-output models (B1, B2, C1, C2): 10 to 30 VDC, Class 2, 200 mA max. 2-output models (B3, C3): 10 to 30 VDC, Class 2, 100 mA max.		
	Residual voltage	1-output models (B1, B2, C1, C2): 2 V max. (Load current: 200 mA, Cable length: 2 m) 2-output models (B3, C3): 2 V max. (Load current: 100 mA, Cable length: 2 m)		
Indicator		Operation indicator (orange, lit) and communication indicator (green, not lit)		
Protection circuits		Power supply reverse polarity protection, Surge suppressor, Output short-circuit protection, Output reverse polarity protection		
Ambient temperature range		Operating: 0 to 85 °C, Storage: -15 to 85 °C (with no icing or condensation) *2		
Ambient humidity range		Operating/Storage: 35% to 95% (with no condensation)		
Temperature influence		±20% max. of sensing distance at 23 °C in the temperature range of 0 to 85 °C		
Voltage influence		±1.5% max. of sensing distance at rated voltage in the rated voltage ±15% range		
Insulation resistance		50 MΩ min. (at 500 VDC) between current-carrying parts and case		
Dielectric strength		1,000 VAC, 50/60 Hz for 1 minute between current-carrying parts and case		
Vibration resistance (destruction)		10 to 55 Hz, 1.5-mm double amplitude for 2 hours each in X, Y, and Z directions		
Shock resistance (destruction)		1,000 m/s ² 10 times each in X, Y, and Z directions		
Degree of protection		IEC 60529: IP67		
Connection method		Pre-wired Models (Standard cable length: 2 m), Pre-wired Connector Models (Standard cable length: 0.3 m)		
Weight (packed state)	Pre-wired	Approx. 140 g	Approx. 160 g	Approx. 225 g
	M12 Pre-wired Smartclick Connector	Approx. 70 g	Approx. 95 g	Approx. 160 g
Materials	Case	E2EW-X□: Stainless steel (SUS303), E2EW-QX□: Fluororesin coating (Base material: (SUS303))		
	Sensing surface	E2EW-X□: Stainless steel (SUS303), E2EW-QX□: Fluororesin coating (Base material: (SUS303))		
	Sensing surface (Thickness)	0.8 mm	0.8 mm	0.8 mm
	Clamping nuts	E2EW-X□: Stainless steel (SUS303), E2EW-QX□: Fluororesin coating (Base material: (SUS303))		
	Toothed washers	Zinc-plated iron		
Cable		Vinyl chloride (PVC)		
Accessories		Instruction manual, Clamping nuts, Toothed washer		

*1. The response frequency is an average value. Measurement conditions are as follows: standard sensing object, a distance of twice the standard sensing object, and a set distance of half the sensing distance.

*2. UL temperature rating is between 0 °C to 60 °C.

Engineering Data (Reference Value)

Sensing Area

PREMIUM Model

Quadruple distance model/
Spatter-resistant Quadruple distance model
Shielded

Sensing object: iron

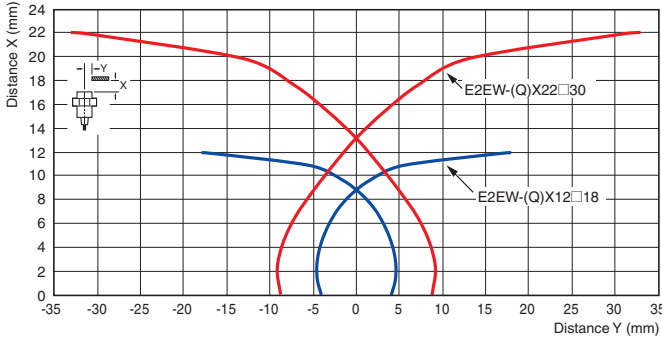

Sensing object: Aluminum

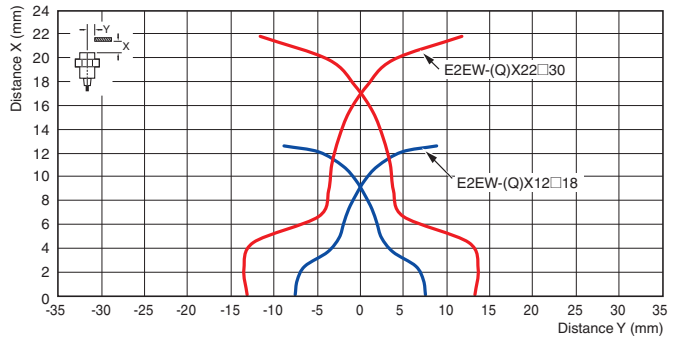

Triple distance model/
Spatter-resistant Triple distance model
Shielded

Sensing object: iron

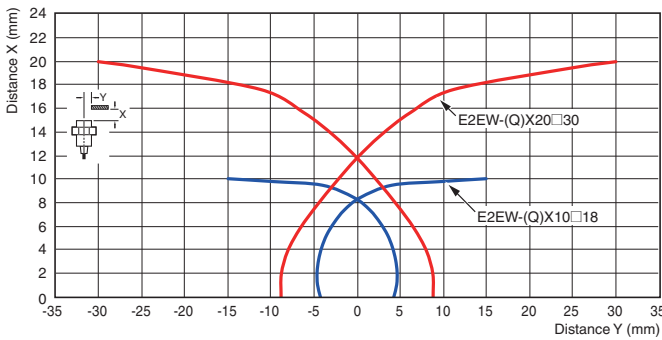

Sensing object: Aluminum

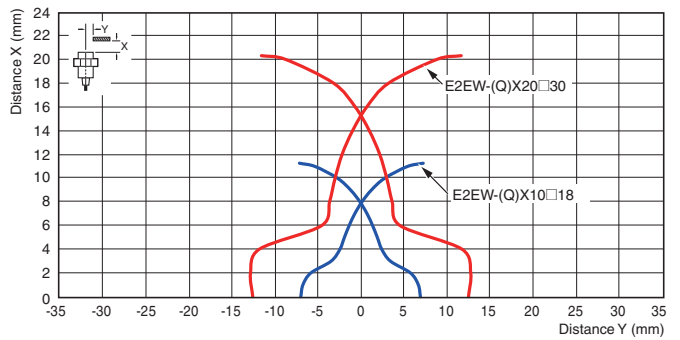

BASIC Model

Single distance model/
Spatter-resistant Single distance model
Shielded

Sensing object: iron

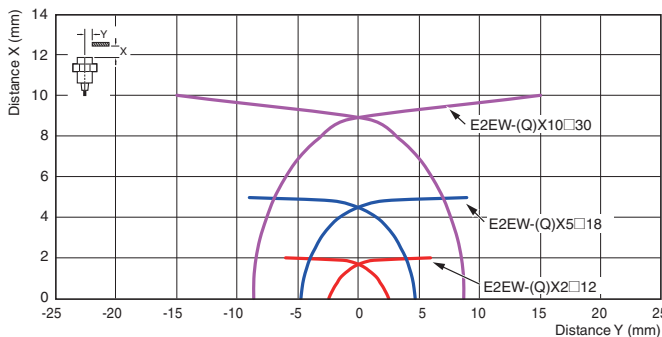

Influence of Sensing Object Size and Material

PREMIUM Model

**Quadruple distance model/
Spatter-resistant Quadruple distance model
Shielded**

Size: M18 E2EW-(Q)X12□18

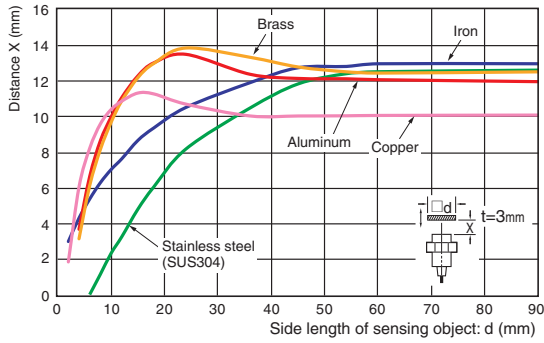

Size: M30 E2EW-(Q)X22□30

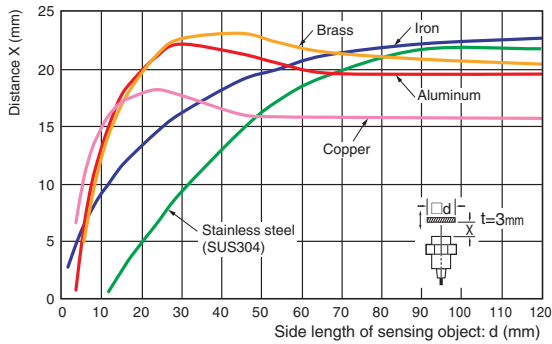

**Triple distance model/
Spatter-resistant Triple distance model
Shielded**

Size: M18 E2EW-(Q)X10□18

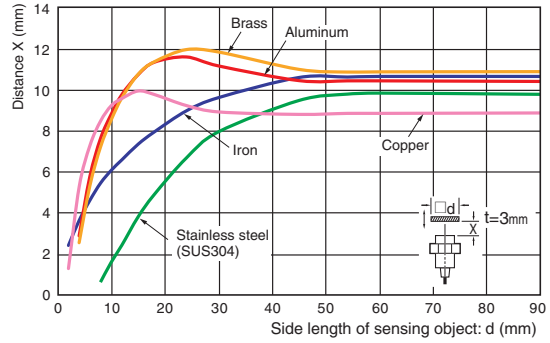

Size: M30 E2EW-(Q)X20□30

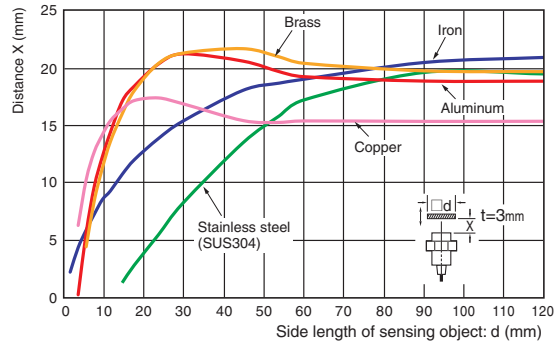

BASIC Model

**Single distance model/
Spatter-resistant Single distance model
Shielded**

Size: M12 E2EW-(Q)X2□12

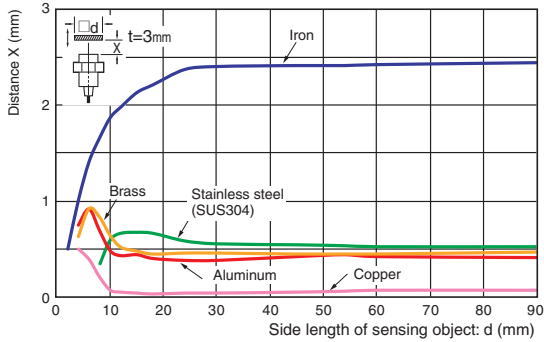

Size: M18 E2EW-(Q)X5□18

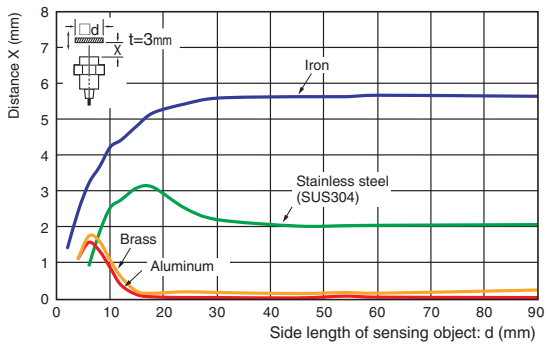

Size: M30 E2EW-(Q)X10□30

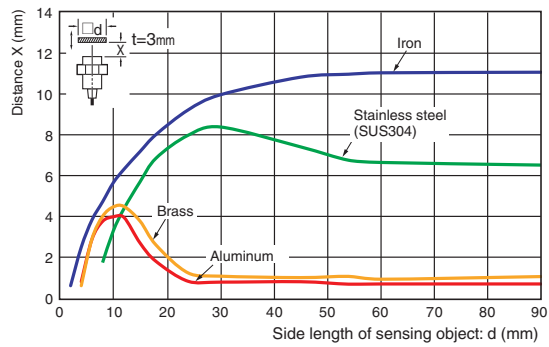

Influence of Sensing Object Thickness and Material

PREMIUM Model

Quadruple distance model/
Spatter-resistant Quadruple distance model
Shielded

Size: M18 E2EW-(Q)X12□18

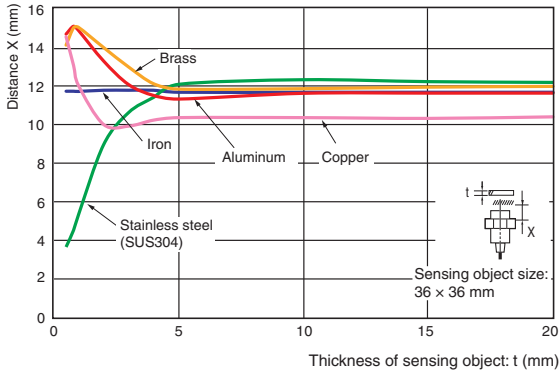

Size: M30 E2EW-(Q)X22□30

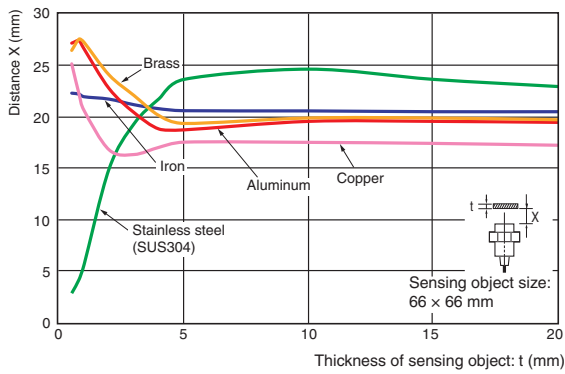

Triple distance model/
Spatter-resistant Triple distance model
Shielded

Size: M18 E2EW-(Q)X10□18

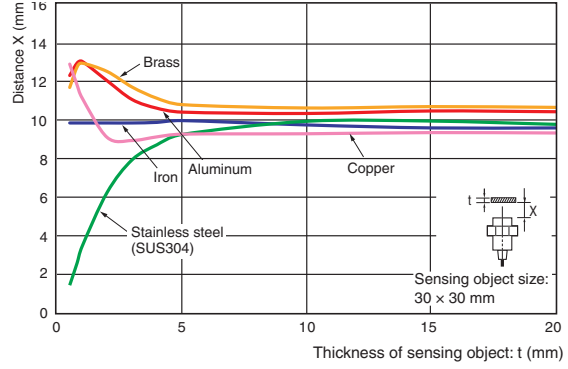

Size: M30 E2EW-(Q)X20□30

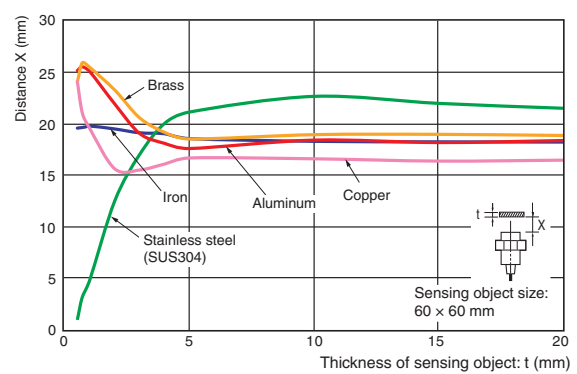

BASIC Model

Single distance model/
Spatter-resistant Single distance model
Shielded

Size: M12 E2EW-(Q)X2□12

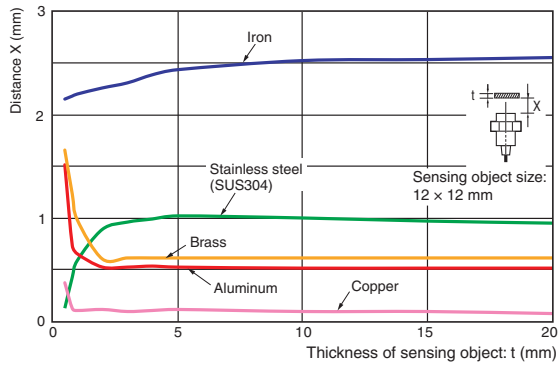

Size: M18 E2EW-(Q)X5□18

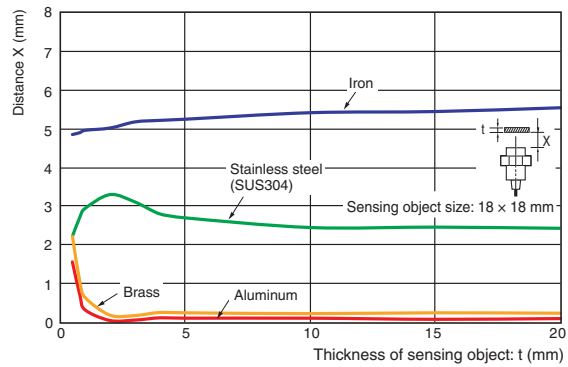

Size: M30 E2EW-(Q)X10□30

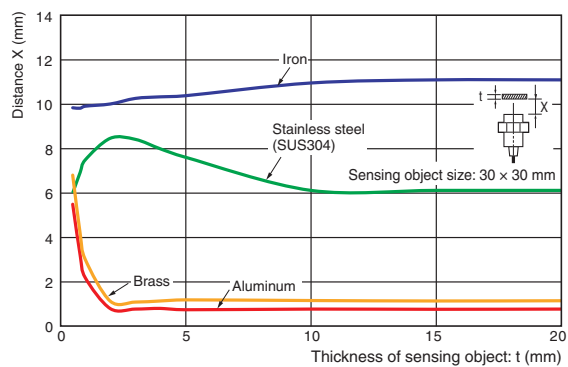

Monitor Output vs. Sensing Distance

PREMIUM Model

Quadruple distance model/
Spatter-resistant Quadruple distance model
Shielded

Size: M18 E2EW-(Q)X12□18

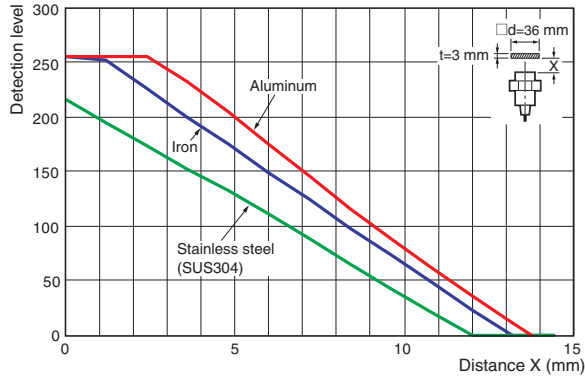

Size: M30 E2EW-(Q)X22□30

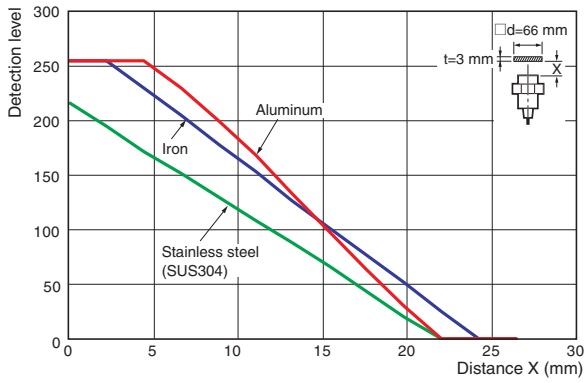

Triple distance model/
Spatter-resistant Triple distance model
Shielded

Size: M18 E2EW-(Q)X10□18

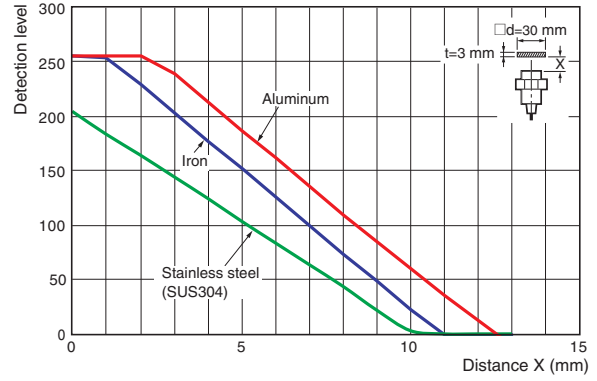

Size: M30 E2EW-(Q)X20□30

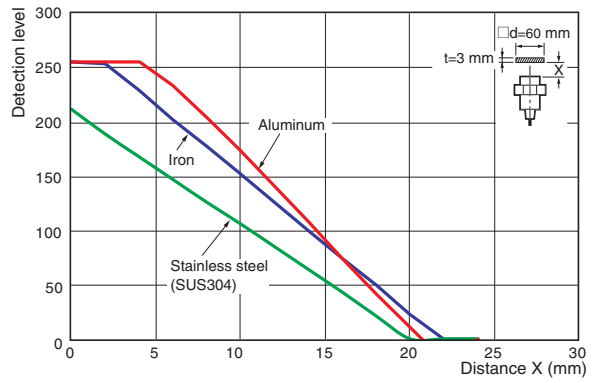

I/O Circuit Diagrams/Timing charts

DC 3-wire

PNP output

PREMIUM Model

Operation mode	Model	Output circuit	
		Standard I/O mode (SIO mode) When using as a general	IO-Link Communication mode (COM mode) When using the Sensor connected to IO-Link Master Unit
NO	E2EW-(Q)X□B1		
NC	E2EW-(Q)X□B2		---
NO+NC	E2EW-(Q)X□B3		

In the IO-Link mode, the cord between the IO-Link master and sensor must have a length of 20 m or less.

Connector Pin Arrangement

M12 Smartclick Connector



PNP output

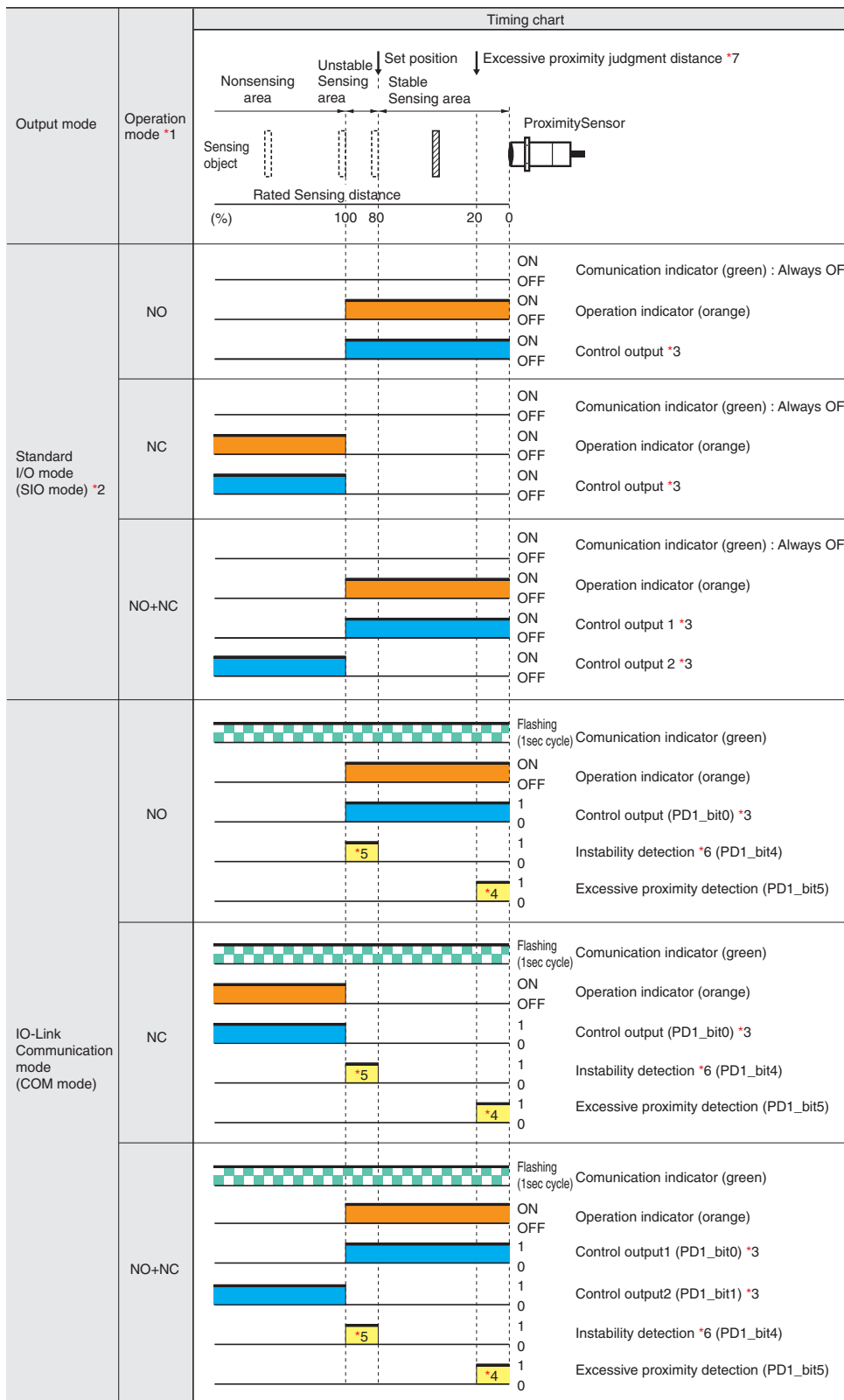

*3. The timer function of the control output can be set up by the IO-Link communications. (It is able to select ON delay, OFF delay, one-shot, or ONOFF delay function and select a timer time of 1 to 16,383ms (T).)

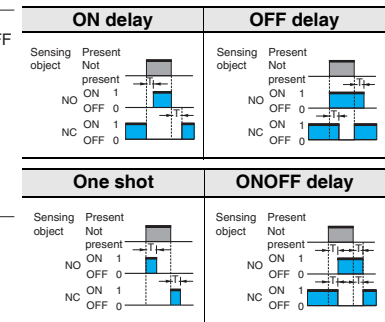

*4. The excessive proximity diagnosis function can be selected by the IO-Link communications.

*5. The instability detection diagnosis can be selected by the IO-Link communications.

*6. The judgment time for the instability detection diagnosis can be selected by the IO-Link communications. (For the ON delay timer function, the setting can be selected from 0 (invalid), 10, 50, 100, 300, 500, or 1000 ms.)

*7. The judgment distance of the excessive proximity diagnosis function can be selected by the IO-Link communications. (The distance can be selected as a combination of the material of the object detected, such as iron, aluminum, or SUS and the judgment distance of approximately 10, 20, or 30%. However, it is not allowed to select a combination of aluminum and 10%.)

Please contact your OMRON sales representative regarding the IO-Link setup file (IODD file).

Please contact your OMRON sales representative regarding assignment of data.

*1. For models with IO-Link, the operation mode can be changed by the IO-Link communications.

*2. If using a model with IO-Link as a general sensor or using a model without IO-Link, it operates in the standard I/O mode (SIO mode).

DC 3-wire

PNP output

BASIC Model

Operation mode	Model	Timing chart	Output circuit
NO	E2EW-(Q)X□B1	<p>ProximitySensor</p> <p>ON Operation indicator (orange)</p> <p>ON Control output</p>	<p>DC10 to 30V</p> <p>Brown (1) +V</p> <p>Black (4) OUT</p> <p>Blue (3) 0V</p>
NC	E2EW-(Q)X□B2	<p>ProximitySensor</p> <p>ON Operation indicator (orange)</p> <p>OFF Control output</p>	<p>DC10 to 30V</p> <p>Brown (1) +V</p> <p>Black (2) OUT</p> <p>Blue (3) 0V</p>
NO+NC	E2EW-(Q)X□B3	<p>ProximitySensor</p> <p>ON Operation indicator (orange)</p> <p>ON Control output 1</p> <p>OFF Control output 2</p>	<p>DC10 to 30V</p> <p>Brown (1) +V</p> <p>Black (4) OUT1</p> <p>White (2) OUT2</p> <p>Blue (3) 0V</p>

Connector Pin Arrangement

M12 Smartclick Connector



E2EW Series

DC 3-wire

NPN OUTPUT

PREMIUM Model

Operation mode	Model	Timing chart	Output circuit
NO	E2EW-(Q)X□C1	<p>ProximitySensor</p> <p>ON Operation indicator OFF (orange) ON Control output OFF</p>	<p>DC10 to 30V Brown (1) +V Load OUT Black (4) Blue (3) 0V</p>
NC	E2EW-(Q)X□C2	<p>ProximitySensor</p> <p>ON Operation indicator OFF (orange) ON Control output OFF</p>	<p>DC10 to 30V Brown (1) +V Load OUT Black (2) Blue (3) 0V</p>

Connector Pin Arrangement

M12 Smartclick Connector



DC 3-wire

NPN OUTPUT **BASIC Model**

Operation mode	Model	Timing chart	Output circuit
NO	E2EW-(Q)X□C1		
NC	E2EW-(Q)X□C2		
NO+NC	E2EW-(Q)X□C3		

Connector Pin Arrangement

M12 Smartclick Connector



E2EW Series

Connections for Sensor I/O Connectors

DC 3-Wire

Proximity Sensor				Sensor I/O Connectors	
Types	Output	Operation mode	Model	Model	Connections *1
DC 3-Wire (M12 Smartclick Connector)	PNP	NO	E2EW-(Q)X□B1□-M1TJ	XS5F-D421-□80-X□ XS5F-D42□-□80-F XS5W-D421-□81-X□ XS5W-D42□-□81-F Note: For details of the connector, refer to <i>XS5 Series</i> on page 42.	
		NC	E2EW-(Q)X□B2□-M1TJ		
		NO+NC	E2EW-(Q)X□B3□-M1TJ		
	NPN	NO	E2EW-(Q)X□C1□-M1TJ		
		NC	E2EW-(Q)X□C2□-M1TJ		
		NO+NC	E2EW-(Q)X□C3□-M1TJ		

*1. If the XS5W Series Connector which has a socket and plug on the cable ends is connected to the Sensor, this part will be a plug.

*2. Different from Proximity Sensor wire colors.



Safety Precautions

Be sure to read the precautions for all models in the website at: <http://www.ia.omron.com/>.

Warning Indications

 WARNING	Warning level Indicates a potentially hazardous situation which, if not avoided, will result in minor or moderate injury, or may result in serious injury or death. Additionally there may be significant property damage.
Precautions for Safe Use	Supplementary comments on what to do or avoid doing, to use the product safely.
Precautions for Correct Use	Supplementary comments on what to do or avoid doing, to prevent failure to operate, malfunction or undesirable effect on product performance.

Meaning of Product Safety Symbols

	General prohibition Indicates the instructions of unspecified prohibited action.
	Caution, explosion Indicates the possibility of explosion under specific conditions.

WARNING

This product is not designed or rated for ensuring safety of persons either directly or indirectly. Do not use it for such purposes.



Otherwise, explosion may result. Never use the product with an AC power supply.



Precautions for Safe Use

The following precautions must be observed to ensure safe operation.

- Do not use the product in environments subject to flammable or explosive gases.
- Do not attempt to disassemble, repair, or modify the product.
- Do not use a voltage that exceeds the rated operating voltage range.
Applying a voltage that is higher than the operating voltage range may result in explosion or fire.
- Be sure that the power supply polarity and other wiring is correct. Incorrect wiring may cause explosion or fire.
- If the power supply is connected directly without a load, the internal elements may explode or burn.
- Dispose of the product according to applicable regulations (laws).

Precautions for Correct Use

Do not use the product in any atmosphere or environment that exceeds the ratings.

Operating Environment

- Do not install the Sensor in the following locations.
 - Outdoor locations directly subject to sunlight, rain, snow, water droplets, or oil.
 - Locations subject to atmospheres with chemical vapors, in particular solvents and acids.
 - Locations subject to corrosive gases.
- The Sensor may malfunction if used near ultrasonic cleaning equipment, high-frequency equipment, transceivers, cellular phones, inverters, or other devices that generate a high-frequency electric field. Please refer to the Precautions for Correct Use on the OMRON website (www.ia.omron.com) for typical measures.
- Laying the Proximity Sensor wiring in the same conduit or duct as high-voltage wires or power lines may result in incorrect operation and damage due to induction. Wire the Sensor using a separate conduit or independent conduit.
- Never use thinner or other solvents. Otherwise, the Sensor surface may be dissolved.
- When turning on the power by influence of temperature environment, an output mis-pulse sometimes occurs. After the sensor has passed for 300 msec after turning on, please use in the stable state.
- The sensor is adjusted with a high degree of accuracy, so do not use in the environment with sudden temperature change.
- Operation check is performed using an OMRON's IO-Link master. If using an IO-Link master from another company, perform the operation check in advance.
- When connecting non IO-Link compliant models to the IO-Link master, use the SIO mode.
- In the IO-Link mode, the cord between the IO-Link master and sensor must have a length of 20 m or less.

E2EW Series

Design

Influence of Surrounding Metal

When mounting the Proximity Sensor, ensure that the minimum distances given in the following table are maintained. If you use a nut, only use the provided nut. And ensure that the minimum distances between the sensing surface and nut is bigger than the "L" given in the following table. Other non-ferrous metals affect sensor's performance in the same way as aluminum. Perform the operation check in advance.

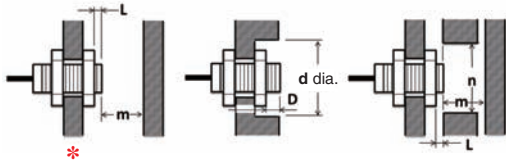

(Unit: mm)

Mounting panel material: Iron

Models	Model	L	d	D	m	n
Quadruple distance model	E2EW-(Q)X12□18	6	54	6	36	54
	E2EW-(Q)X22□30	8	90	8	66	90
Triple distance model	E2EW-(Q)X10□18	2	54	2	30	54
	E2EW-(Q)X20□30	0	30	0	60	90
Single distance model	E2EW-(Q)X2□12	0	12	0	8	40
	E2EW-(Q)X5□18	0	18	0	20	60
	E2EW-(Q)X10□30	0	30	0	40	100

Mounting panel material: Aluminum

Models	Model	L	d	D	m	n
Quadruple distance model	E2EW-(Q)X12□18	12	80	12	36	80
	E2EW-(Q)X22□30	16	120	16	66	120
Triple distance model	E2EW-(Q)X10□18	12	80	12	30	80
	E2EW-(Q)X20□30	16	120	16	60	120
Single distance model	E2EW-(Q)X2□12	12	70	12	8	70
	E2EW-(Q)X5□18	12	80	12	20	80
	E2EW-(Q)X10□30	16	120	16	40	120

* If you use the model E2EW-(Q)X22□30, or E2EW-(Q)X20□30, the panel thickness (t) is 3 mm or less.

When the Proximity Sensor is mounted in metal, ensure that the minimum distances given in the following table are maintained.

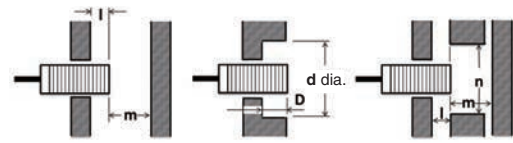

(Unit: mm)

Embedded material: Iron

Models	Model	l	d	D	m	n
Quadruple distance model	E2EW-(Q)X12□18	6	54	6	36	54
	E2EW-(Q)X22□30	8	90	8	66	90
Triple distance model	E2EW-(Q)X10□18	0	18	0	30	54
	E2EW-(Q)X20□30	0	30	0	60	90
Single distance model	E2EW-(Q)X2□12	0	12	0	8	40
	E2EW-(Q)X5□18	0	18	0	20	60
	E2EW-(Q)X10□30	0	30	0	40	100

Embedded material: Aluminum

Models	Model	l	d	D	m	n
Quadruple distance model	E2EW-(Q)X12□18	12	80	12	36	80
	E2EW-(Q)X22□30	16	120	16	66	120
Triple distance model	E2EW-(Q)X10□18	12	80	12	30	80
	E2EW-(Q)X20□30	16	120	16	60	120
Single distance model	E2EW-(Q)X2□12	12	70	12	8	70
	E2EW-(Q)X5□18	12	80	12	20	80
	E2EW-(Q)X10□30	16	120	16	40	120

Mutual Interference

When installing two or more Proximity Sensors face-to-face or side-by-side, ensure that the minimum distances given in the following table are maintained.

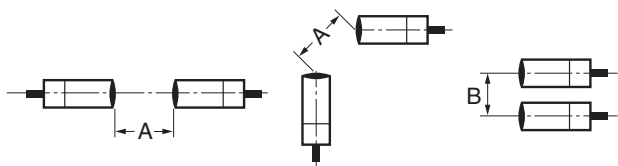

(Unit: mm)

Models	Model	Item	
		A	B
Quadruple distance model	E2EW-(Q)X12□18	80	60
	E2EW-(Q)X22□30	135	110
Triple distance model	E2EW-(Q)X10□18	80	60
	E2EW-(Q)X20□30	135	110
Single distance model	E2EW-(Q)X2□12	40	35
	E2EW-(Q)X5□18	65	60
	E2EW-(Q)X10□30	110	100

Chips from Cutting Aluminum

Normally, chips from cutting aluminum will not cause a detection signal to be output even if it adheres to or accumulates on the detection surface. In the following cases, however, a detection signal may be output.

Remove the cutting chips in these cases.

1. If $d \geq 2/3D$ at the center of the detection surface where d is the cutting chip size and D is the detection surface size

(Unit: mm)

Model	Dimension	D
E2EW-(Q)X□12		10
E2EW-(Q)X□18		16
E2EW-(Q)X□30		28

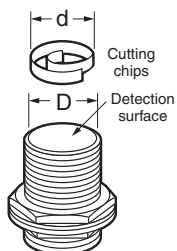

2. If the cutting chips are pressed down

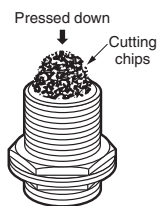

Mounting

Tightening Force

Do not tighten the nut with excessive force.

A washer must be used with the nut.

The tightening force must be the same or less than the figures in the following table.



Quadruple distance model, Triple distance model, Single distance model

Size	Torque	
	E2EW-X□	E2EW-QX□
M12	30 N·m	15 N·m
M18	70 N·m	35 N·m
M30	180 N·m	60 N·m

Note: When mounting the Proximity Sensor, only use the provided nut. Do not use set screws. The Sensor may malfunction.

E2EW Series

Dimensions

(Unit: mm)

Tolerance class IT16 applies to dimensions in this data sheet unless otherwise specified.

Sensors

PREMIUM Model

E2EW/E2EW-Q Series

(Quadruple distance/Triple distance/Spatter-resistant Quadruple distance, Spatter-resistant Triple distance model)

Pre-wired Model



E2EW-X12□□□18/E2EW-QX12□□□18
E2EW-X10□□□18/E2EW-QX10□□□18

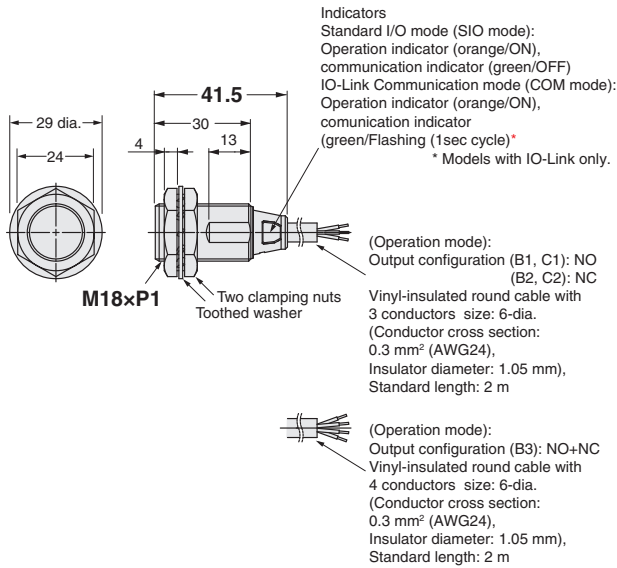

Pre-wired Connector Model



E2EW-X12□□□18-M1TJ
E2EW-X10□□□18-M1TJ
E2EW-QX12□□□18-M1TJ
E2EW-QX10□□□18-M1TJ

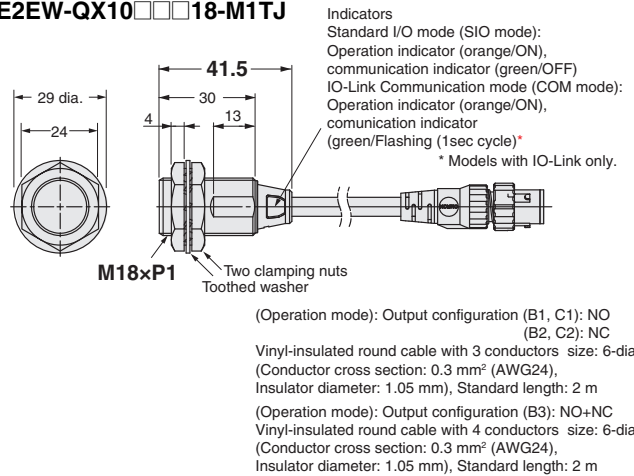

E2EW-X22□□□30/E2EW-QX22□□□30
E2EW-X20□□□30/E2EW-QX20□□□30

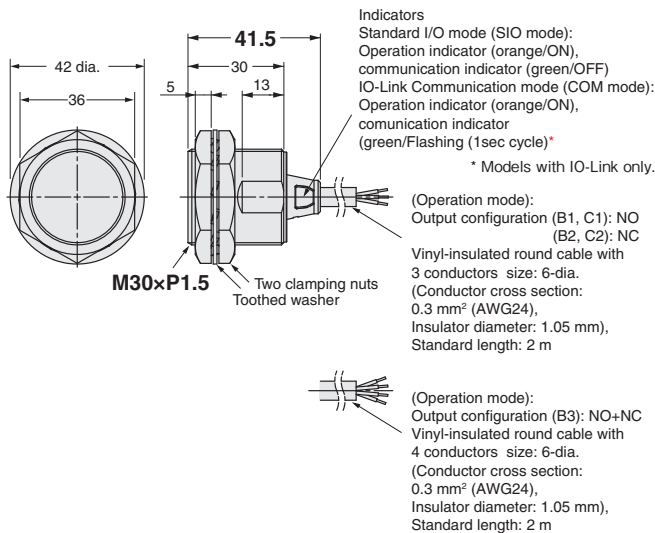

E2EW-X22□□□30-M1TJ
E2EW-X20□□□30-M1TJ
E2EW-QX22□□□30-M1TJ
E2EW-QX20□□□30-M1TJ

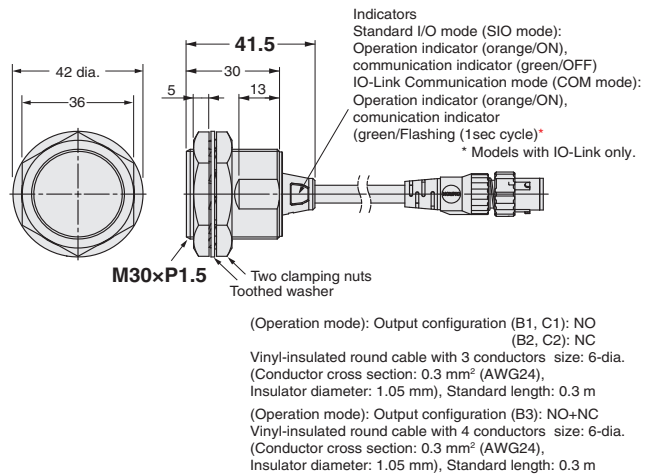

Mounting Hole Dimensions

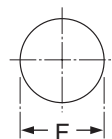

Dimensions	F (mm)
M18	18.5 dia. ^{+0.5} / ₀
M30	30.5 dia. ^{+0.5} / ₀

Angle R of the Bending Wire

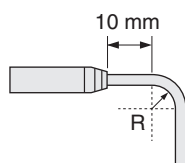

Dimensions	R (mm)
M18	18
M30	

BASIC Model

E2EW/E2EW-Q Series (Single distance model/Spatter-resistant Single distance model)

Pre-wired Model



E2EW-X2□□12
E2EW-QX2□□12

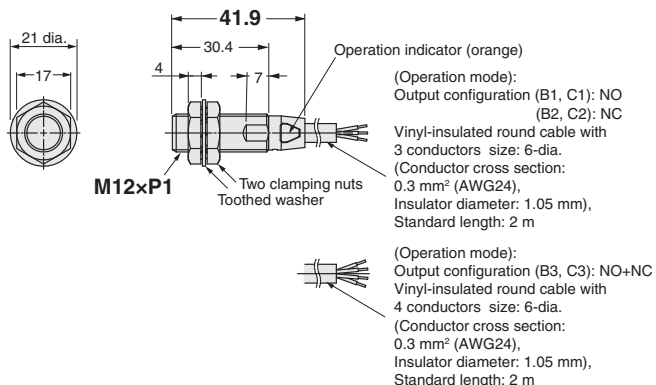

Pre-wired Connector Model



E2EW-X2□□12-M1TJ
E2EW-QX2□□12-M1TJ

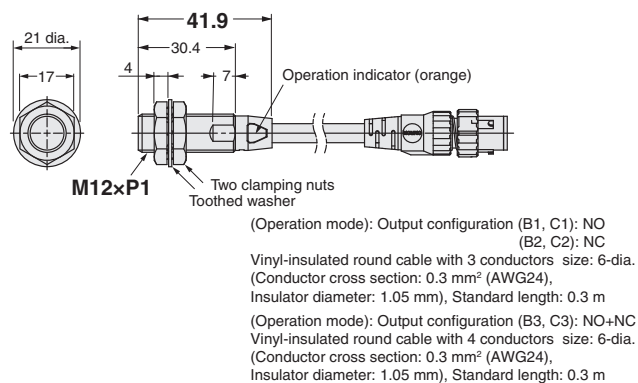

E2EW-X5□□18
E2EW-QX5□□18

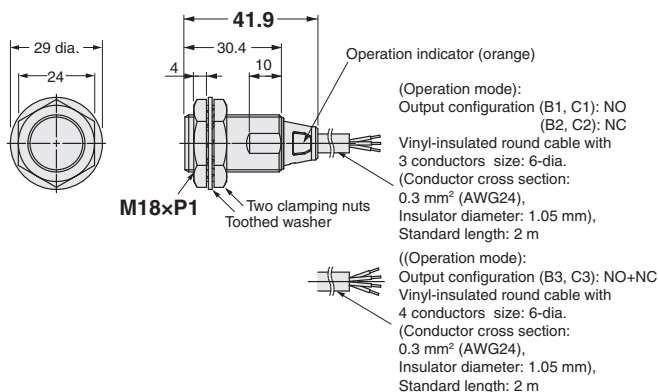

E2EW-X5□□18-M1TJ
E2EW-QX5□□18-M1TJ

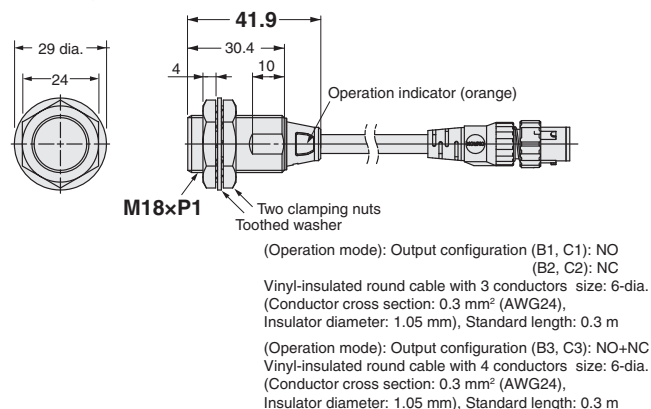

E2EW-X10□□30
E2EW-QX10□□30

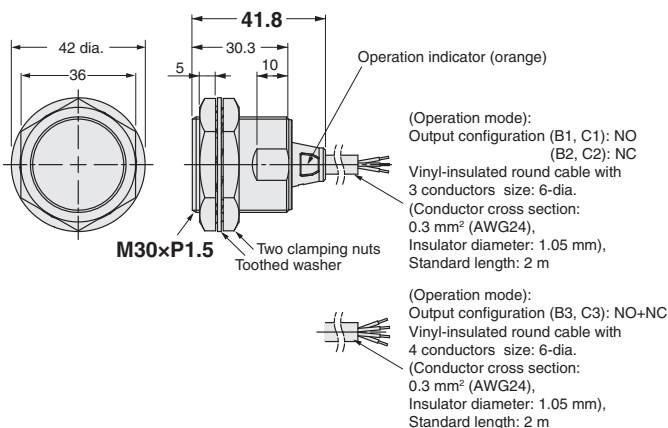

E2EW-X10□□30-M1TJ
E2EW-QX10□□30-M1TJ

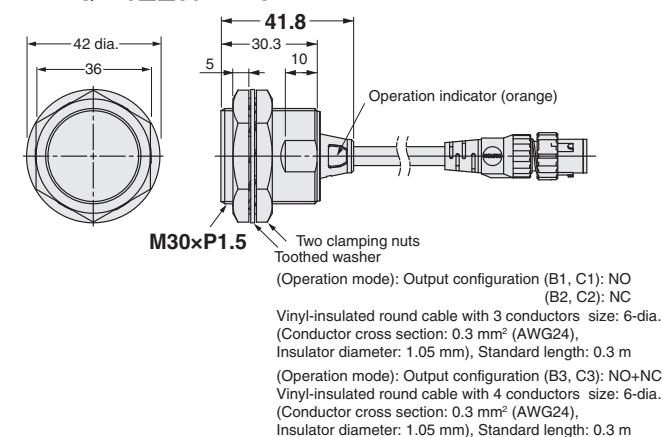

Mounting Hole Dimensions

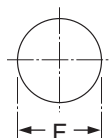

Dimensions	F (mm)
M12	12.5 dia. ^{+0.5} / ₀
M18	18.5 dia. ^{+0.5} / ₀
M30	30.5 dia. ^{+0.5} / ₀

Angle R of the Bending Wire

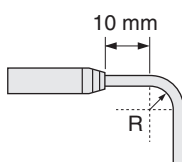

Dimensions	R (mm)
M12	18
M18	
M30	

XS5

Round Water-resistive Smartclick Connectors for E2E NEXT Series proximity sensors that Reduce Installation Work

- A newly developed lock mechanism that is compatible with round M12 connectors.
- Simply insert the Connectors, then turn them approximately 1/8 of a turn to lock.
- A positive click indicates locking.
- IP67 degree of protection.
- UL approved products.



For the most recent information on models that have been certified for safety standards, refer to your OMRON website.

 Be sure to read *Safety Precautions* on page 48.

Model Number Structure

Model Number Legend

Use this legend when determining the product specifications from the model number. When ordering, use a model number from the table in **Ordering Information**.

XS5 1 2 3 4 5 6 7 8 9 **-D 4 2** **-** **8** **- F**

1. Type

W: Connectors connected to cable, socket and plug on cable ends
F: Connectors connected to cable, socket on one cable end

2. Mating Section Form

D: A-coding (for DC sensor)

3. Connector Poles

4: 4 poles

4. Contact Plating

2: Gold plating

5. Cable Connection Direction

XS5W

- 1: Straight (Socket)/Straight (Plug)
- 2: Right-angle (Socket)/Right-angle (Plug)
- 3: Straight (Socket)/Right-angle (Plug)
- 4: Right-angle (Socket)/Straight (Plug)

XS5F

- 1: Straight
- 2: Right-angle

6. Cable Length

- C: 1 m
- D: 2 m
- E: 3 m
- G: 5 m
- J: 10 m

7. Connections (Numbers inside circles are terminal numbers)

8: ①Brown, ②White, ③Blue, ④ Black

8. Connectors on One End/Both Ends

- 0: Sockets on One Cable End
- 1: Socket and Plug on Cable Ends

9. Cable Specifications

F: Robot cable

 Smartclick is registered trademark of OMRON Corporation.

Ordering Information

Connectors

Type	Cable outer diameter (mm)	Cable Connection Direction	Cable length (m)	Model	UL
Socket and Plug on Cable Ends XS5W	6 dia.	Straight (Socket)/Straight (Plug)	1	XS5W-D421-C81-F	UL2238 certified (File no. E207683)
			2	XS5W-D421-D81-F	
			3	XS5W-D421-E81-F	
			5	XS5W-D421-G81-F	
			10	XS5W-D421-J81-F	
		Right-angle (Socket)/Right-angle (Plug)	2	XS5W-D422-D81-F	
			5	XS5W-D422-G81-F	
		Straight (Socket)/Right-angle (Plug)	2	XS5W-D423-D81-F	
			5	XS5W-D423-G81-F	
		Right-angle (Socket)/Straight (Plug)	2	XS5W-D424-D81-F	
			5	XS5W-D424-G81-F	
		Sockets on One Cable End XS5F	6 dia.	Straight type	
2	XS5F-D421-D80-F				
3	XS5F-D421-E80-F				
5	XS5F-D421-G80-F				
10	XS5F-D421-J80-F				
Right-angle type	1			XS5F-D422-C80-F	
	2			XS5F-D422-D80-F	
	3			XS5F-D422-E80-F	
	5			XS5F-D422-G80-F	
	10			XS5F-D422-J80-F	

Accessories (Sold Separately)

Connector Covers

Water-resistant Covers

Model	Material	Suitable connector		Remarks
		Model	Mounting portion	
XS2Z-11	Brass/ Nickel plated	XS5W	M12 male screw	This provides IP67 levels of protection. When mounting the Water-resistant Cover to a Connector, be sure to apply a torque range between 0.39 and 0.49 N·m to tighten the Water-resistant Cover.
XS5Z-11	PBT	XS5F/XS5W	M12 female screw	This provides IP67 levels of protection. This uses the Smart click mechanism. There's no need to keep track of locking torque.

Water-resistant Covers

XS2Z-11

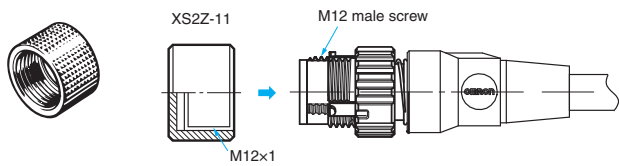

XS5Z-11

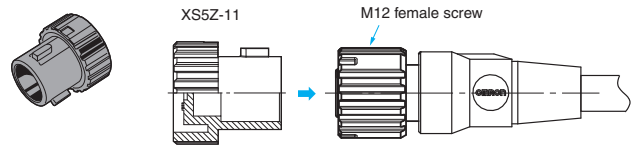

Dust Covers

Model	Material	Suitable connector		Remarks
		Model	Mounting portion	
XS2Z-13	Rubber/Black	XS5W	M12 male screw	The Dust Cover is for dust prevention and does not ensure IP67 degree of protection. When mounting the Dust Cover to a connector, be sure to press the Dust Cover onto the Connector until the Connector is fully inserted into the Dust Cover.
XS2Z-14		XS5F/XS5W	Contact blocks (female contact)	
XS2Z-15			M12 female screw	

Dust Covers

XS2Z-13

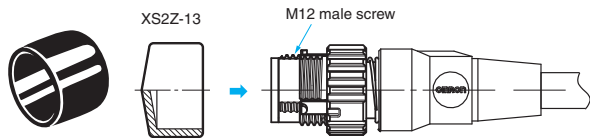

XS2Z-15/XS2Z-14

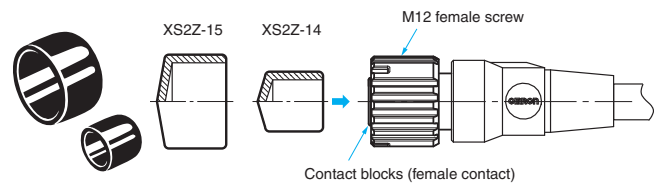

Ratings and Specifications

Rated current	4 A
Rated voltage	250 VDC
Contact resistance (connector)	40 mΩ max. (at 20 mV max., 100 mA max.)
Insulation resistance	1,000 MΩ min. (at 500 VDC) *1
Dielectric strength (connector)	1,500 VAC for 1 minute (leakage current: 1 mA max.)
Degree of protection	IP67 (IEC 60529)
Insertion tolerance	50 times
Lock strength	Tensile: 100 N/15 s, Torsion: 1 N·m/15 s
Cable holding strength	Tensile: 100 N/15 s, Torsion: 1 N·m/15
Lock operating force	0.1 to 0.25 N·m
Ambient operating temperature range	-25 to 70°C *2
Ambient humidity range	20 to 85%RH



*1. State at shipping.

*2. Use the robot cable within a temperature range of 0 to 70°C to avoid the wire breakage when moving.

Materials and Finishes

Item	Model	XS5W/XS5F
Contacts		Copper alloy/Gold plating
Fixtures		Zinc alloy/Nickel plating
Pin block		PBT resin
O-ring		Rubber
Cover		PBT resin
Cable		UL13 (CL3), UL758 (AWM), 6 mm dia., AWG20

Connector Pinout Diagram (from Mating Side)

Item	No. of poles	4 poles
A-coding (For DC sensors)	Male (plug) contacts	
	Female (socket) contacts	

Connection

Socket	Plug OMRON model No.	Smartclick Plug Connectors	M12 Plug Connectors
		XS5H, XS5G, XS5W (plug side), XS5R (plug side), XS5M *	XS2H, XS2G, XS2W (plug side), XS2R (plug side), XS2M *
Smartclick Socket Connectors	XS5F, XS5C XS5W (socket side), XS5R (socket side), XS5P *	⊙	○
M12 Socket Connectors	XS2F, XS2C, XS2W (socket side), XS2R (socket side), XS2P *	○	○

* XS2P/XS5P and XS5M, XS2M cannot mate with each other.

Note: ⊙: Connected by twisting.

○: Connected by screwing.

XS5

Dimensions

(Unit: mm)

Socket and Plug on Cable Ends XS5W

Straight (Socket)/straight (Plug)

XS5W-D421-□81-F

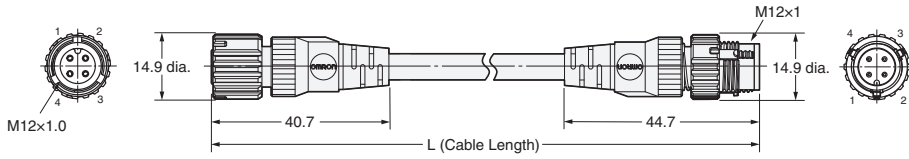

Right-angle (Socket)/right-angle (Plug)

XS5W-D422-□81-F

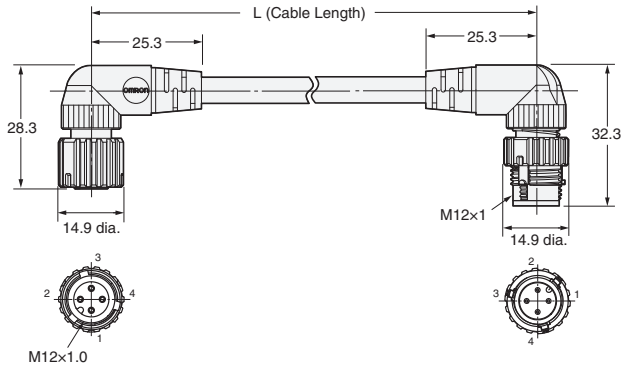

Wiring Diagram for 4 Cores

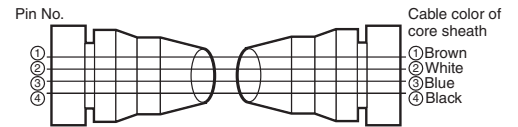

Straight (Socket)/right-angle (Plug)

XS5W-D423-□81-F

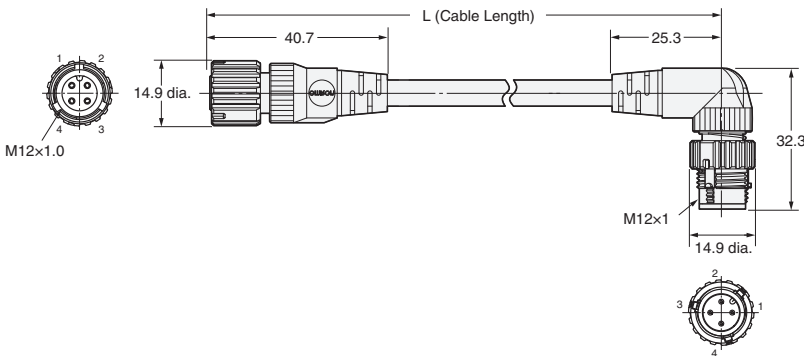

Right-angle (Socket)/straight (Plug)

XS5W-D424-□81-F

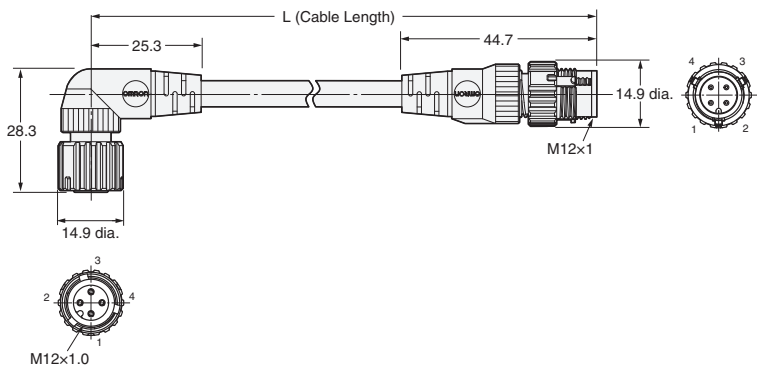

Sockets on One Cable End XS5F

Straight type

XS5F-D421-□80-F

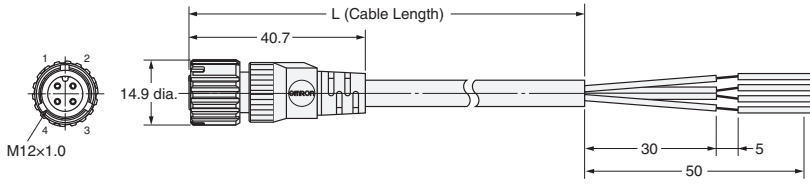

Right-angle type

XS5F-D422-□80-F

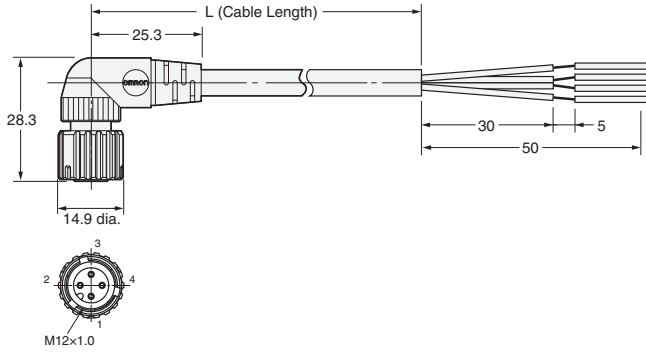

Wiring Diagram for 4 Cores

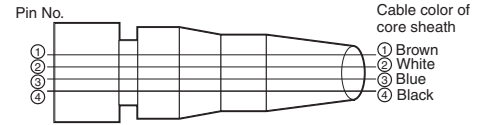

Safety Precautions

Meaning of Display

Precautions for Safe Use	Supplementary comments on what to do or avoid doing, to use the product safely.
Precautions for Correct Use	Supplementary comments on what to do or avoid doing, to prevent failure to operate, malfunction, or undesirable effects on product performance.

Precautions for Safe Use

Degree of Protection

Do not use the product if its protective capabilities have been compromised, such as through swelling or cracks to housing or seal materials.

Breakages or damage from fire may occur when products in this state continue to be used.

Connector Connection and Disconnection

- When connecting or disconnecting Connectors, be sure to hold the Connectors by hand.
- Do not hold the cable when disconnecting Connectors. Check the alignment using the slot in the polarity key.
- Do not wiring the Connector when your hands are wet. Malfunctions or device damage may occur when power is supplied to a device.
- When mating Connectors, be sure to insert the plug all the way to the back of the socket before attempting to lock the Connectors. After you lock a Connector, always confirm that it is mated properly.
- Do not use tools of any sort to mate the Connectors. Always use your hands. Pliers or other tools may damage the Connectors.
- When you replace a Connector, make sure that there is no liquid, cutting oil, or other foreign matter on the mating surfaces before you mate the Connector.

Disposal

Dispose of this product as industrial waste.

Precautions for Correct Use

- Do not use the Connectors in an atmosphere or environment that exceeds the specifications.
- Always turn OFF the power supply before wiring. Failure to turn OFF the power supply may lead to electric shock or damage to devices.
- Environments with corrosive gases and high temperature and humidity can cause bad connections and damage through corrosion, leading to degraded performance, therefore do not use these products in such environments.
- Do not pull on the Connectors or cables with excessive force.
- Do not step on or place any objects on the Connectors. Doing so may damage the Connectors.
- Lay the cable where it will not be stepped on to prevent the wires in the cable from being disconnected and to protect the Connectors from being damaged. If the cable must be placed where it will be stepped on, install a protective cover.
- At installation, if not installing sensors or switches, and not mating plug connectors, then use water-resistant covers (XS5Z-11, XS2Z-11) or dust-resistant covers (XS2Z-13/14/15) in order to ensure correct connector mating.

Wiring

- Do not wire cables in environments in which the cable terminal sections will be subject to fluids such as water or cutting oil.
- When wiring cables, ensure this is carried out in accordance with the wiring diagram.
- Lay the cables so that external force is not applied to the Connectors. Otherwise, the degree of protection (IP67G) may not be achieved.

Degree of Protection (IP67)

- The degree of protection of Connectors (IP67) is not for a fully watertight structure. Do not use the Connectors underwater.
- Do not step on or place any objects on the Connectors. Doing so may damage the Connectors.

Setup

- Do not install the Connectors with a load placed directly on the joint or at the point where the wires connect to the Connector. The Connector may be damaged or the wires in the cable may be disconnected.
- If bending cables, ensure that these use a minimum bend radius of 40 mm.

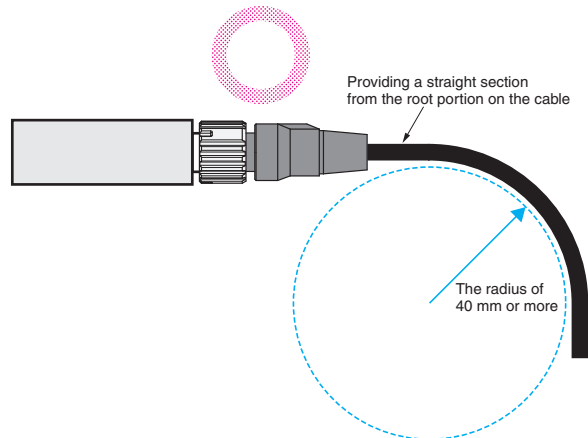
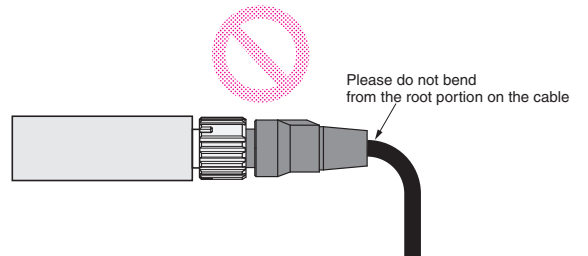

Connecting

1. Connecting the XS5 Plug and Socket

- Align the projection on the plug cover with the polarity key on the socket, then insert the plug all the way in.

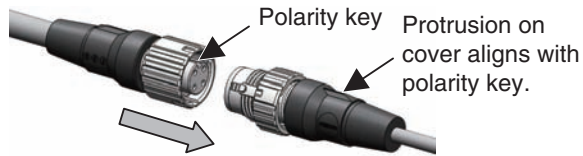

- Hold the knurled socket grip, then insert the projection on the plug into the groove of the socket.

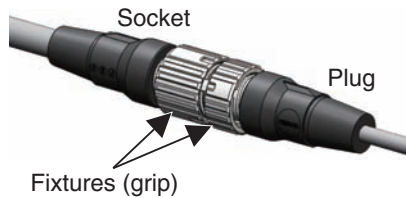

- Turn the knurled grips of the socket clockwise approximately 1/8 turn in respect to the plug. A click will indicate that the Connectors are locked. The locking condition can also be confirmed by the alignment marks on the plug and socket.

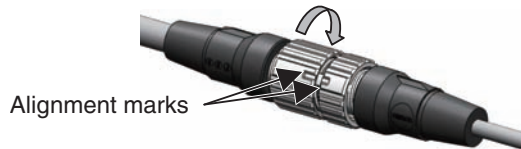

2. Connecting the XS5 and XS2

- Align the projection on the plug cover with the polarity key on the socket, then insert the plug all the way in.
- In the same way as when connecting two XS2 Connectors, screw the knurled grip in the clockwise direction.
- Use your fingers to tighten the Connectors sufficiently.

Terms and Conditions Agreement

Read and understand this catalog.

Please read and understand this catalog before purchasing the products. Please consult your OMRON representative if you have any questions or comments.

Warranties.

- (a) Exclusive Warranty. Omron's exclusive warranty is that the Products will be free from defects in materials and workmanship for a period of twelve months from the date of sale by Omron (or such other period expressed in writing by Omron). Omron disclaims all other warranties, express or implied.
- (b) Limitations. OMRON MAKES NO WARRANTY OR REPRESENTATION, EXPRESS OR IMPLIED, ABOUT NON-INFRINGEMENT, MERCHANTABILITY OR FITNESS FOR A PARTICULAR PURPOSE OF THE PRODUCTS. BUYER ACKNOWLEDGES THAT IT ALONE HAS DETERMINED THAT THE PRODUCTS WILL SUITABLY MEET THE REQUIREMENTS OF THEIR INTENDED USE.

Omron further disclaims all warranties and responsibility of any type for claims or expenses based on infringement by the Products or otherwise of any intellectual property right. (c) Buyer Remedy. Omron's sole obligation hereunder shall be, at Omron's election, to (i) replace (in the form originally shipped with Buyer responsible for labor charges for removal or replacement thereof) the non-complying Product, (ii) repair the non-complying Product, or (iii) repay or credit Buyer an amount equal to the purchase price of the non-complying Product; provided that in no event shall Omron be responsible for warranty, repair, indemnity or any other claims or expenses regarding the Products unless Omron's analysis confirms that the Products were properly handled, stored, installed and maintained and not subject to contamination, abuse, misuse or inappropriate modification. Return of any Products by Buyer must be approved in writing by Omron before shipment. Omron Companies shall not be liable for the suitability or unsuitability or the results from the use of Products in combination with any electrical or electronic components, circuits, system assemblies or any other materials or substances or environments. Any advice, recommendations or information given orally or in writing, are not to be construed as an amendment or addition to the above warranty.

See <http://www.omron.com/global/> or contact your Omron representative for published information.

Limitation on Liability; Etc.

OMRON COMPANIES SHALL NOT BE LIABLE FOR SPECIAL, INDIRECT, INCIDENTAL, OR CONSEQUENTIAL DAMAGES, LOSS OF PROFITS OR PRODUCTION OR COMMERCIAL LOSS IN ANY WAY CONNECTED WITH THE PRODUCTS, WHETHER SUCH CLAIM IS BASED IN CONTRACT, WARRANTY, NEGLIGENCE OR STRICT LIABILITY.

Further, in no event shall liability of Omron Companies exceed the individual price of the Product on which liability is asserted.

Suitability of Use.

Omron Companies shall not be responsible for conformity with any standards, codes or regulations which apply to the combination of the Product in the Buyer's application or use of the Product. At Buyer's request, Omron will provide applicable third party certification documents identifying ratings and limitations of use which apply to the Product. This information by itself is not sufficient for a complete determination of the suitability of the Product in combination with the end product, machine, system, or other application or use. Buyer shall be solely responsible for determining appropriateness of the particular Product with respect to Buyer's application, product or system. Buyer shall take application responsibility in all cases.

NEVER USE THE PRODUCT FOR AN APPLICATION INVOLVING SERIOUS RISK TO LIFE OR PROPERTY OR IN LARGE QUANTITIES WITHOUT ENSURING THAT THE SYSTEM AS A WHOLE HAS BEEN DESIGNED TO ADDRESS THE RISKS, AND THAT THE OMRON PRODUCT(S) IS PROPERLY RATED AND INSTALLED FOR THE INTENDED USE WITHIN THE OVERALL EQUIPMENT OR SYSTEM.

Programmable Products.

Omron Companies shall not be responsible for the user's programming of a programmable Product, or any consequence thereof.

Performance Data.

Data presented in Omron Company websites, catalogs and other materials is provided as a guide for the user in determining suitability and does not constitute a warranty. It may represent the result of Omron's test conditions, and the user must correlate it to actual application requirements. Actual performance is subject to the Omron's Warranty and Limitations of Liability.

Change in Specifications.

Product specifications and accessories may be changed at any time based on improvements and other reasons. It is our practice to change part numbers when published ratings or features are changed, or when significant construction changes are made. However, some specifications of the Product may be changed without any notice. When in doubt, special part numbers may be assigned to fix or establish key specifications for your application. Please consult with your Omron's representative at any time to confirm actual specifications of purchased Product.

Errors and Omissions.

Information presented by Omron Companies has been checked and is believed to be accurate; however, no responsibility is assumed for clerical, typographical or proofreading errors or omissions.

Related products

Proximity Sensors **E2E NEXT Series**
DC 2-Wire and 3-Wire Models

- Exceptional sensing range^{*1} approximately double the sensing distance of previous models.
- With high-brightness LED, the indicator is visible anywhere from 360°.
- Only 10 seconds^{*2} to replace a Proximity Sensor with the "e-jig" (Mounting Sleeve).
- Cables with enhanced oil resistance enabled 2-year oil resistance^{*3}.

*1. Based on December 2018 OMRON investigation.
 *2. Time required to adjust the distance when installing a Sensor. Based on OMRON investigation.
 *3. Refer to *Ratings and Specifications* on the catalog for details.
 However, E2E Connector Models and E2EQ series are excluded.



Refer to the catalog for details.
Cat. No. D121

Exceptional sensing range Proximity Sensors (E2E NEXT Series/E2EW Series)

More E2E NEXT and E2EW products are scheduled to be released for the complete lineup. (As of December 2019)

	Proximity Sensors E2E NEXT Series		Welding Proximity Sensors E2EW Series	
	DC 3-wire	DC 2-wire	DC 3-wire	DC 2-wire
PREMIUM Models	Available IO-Link	Available	Available IO-Link	—
BASIC Models	Available IO-Link	Scheduled for release	Available	Scheduled for release

Smartclick is a registered trademark of OMRON Corporation.

Company names and product names in this document are the trademarks or registered trademarks of their respective companies.

The product photographs and figures that are used in this catalog may vary somewhat from the actual products.

OMRON Corporation Industrial Automation Company
Kyoto, JAPAN

Contact: www.ia.omron.com

Regional Headquarters

OMRON EUROPE B.V.

Wegalaan 67-69, 2132 JD Hoofddorp
The Netherlands
Tel: (31)2356-81-300/Fax: (31)2356-81-388

OMRON ASIA PACIFIC PTE. LTD.

No. 438A Alexandra Road # 05-05/08 (Lobby 2),
Alexandra Technopark,
Singapore 119967
Tel: (65) 6835-3011/Fax: (65) 6835-2711

OMRON ELECTRONICS LLC

2895 Greenspoint Parkway, Suite 200
Hoffman Estates, IL 60169 U.S.A.
Tel: (1) 847-843-7900/Fax: (1) 847-843-7787

OMRON (CHINA) CO., LTD.

Room 2211, Bank of China Tower,
200 Yin Cheng Zhong Road,
PuDong New Area, Shanghai, 200120, China
Tel: (86) 21-5037-2222/Fax: (86) 21-5037-2200

Authorized Distributor:

© OMRON Corporation 2019 All Rights Reserved.
In the interest of product improvement,
specifications are subject to change without notice.

CSM_3_1_0120

Cat. No. D122-E1-02

1219 (0619)