

OLYMPUS®

DIGITAL VOICE
RECORDER

DS-50

DS-40

DS-30

INSTRUCTIONS

EN INSTRUCTIONS

FR MODE D'EMPLOI

ES INSTRUCCIONES

Thank you for purchasing an Olympus
Digital Voice Recorder.

Please read these instructions for information
about using the product correctly and safely.
Keep the instructions handy for future reference.

To ensure successful recordings, we
recommend that you test the record function
and volume before use.

Introduction

- The contents of this document may be changed in the future without advanced notice. Contact our Customer Support Center for the latest information relating to product names and model numbers.
- The utmost care has been taken to ensure the integrity of the contents of this document. In the unlikely event that a questionable item, error, or omission is found, please contact our Customer Support Center.
- Any liability for passive damages or damage of any kind occurred due to data loss incurred by a defect of the product, repair performed by the third party other than Olympus or an Olympus authorized service station, or any other reasons is excluded from the Olympus's liability.

Trademarks

IBM and PC/AT are the trademarks or registered trademarks of International Business Machines Corporation.

Microsoft, Windows and Windows Media are registered trademarks of Microsoft Corporation.

MPEG Layer-3 audio coding technology licensed from Fraunhofer IIS and Thomson.

The product was developed based on noise-canceling technology under license from NEC Corporation.

IBM ViaVoice and Dragon NaturallySpeaking are the trademarks or registered trademarks of Nuance Communications Inc.

Other product and brand names mentioned herein may be the trademarks or registered trademarks of their respective owners.



INDEX

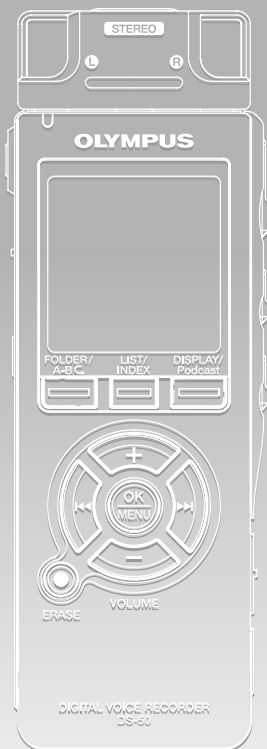

Table of Contents	P4
--------------------------	-----------

Safe and Proper Usage	P6
------------------------------	-----------

Getting Started	P9
------------------------	-----------

About Recording	P23
------------------------	------------

About Playback	P34
-----------------------	------------

Erase and other functions	P47
----------------------------------	------------

Display and Sound Functions	P55
------------------------------------	------------

Menu Setting	P60
---------------------	------------

Using the Recorder on Your PC	P65
--------------------------------------	------------

Managing Files on Your PC	P76
----------------------------------	------------

DSS Player Expanded Functions	P77
--------------------------------------	------------

Importing Content for Listening on the Recorder	P79
--------------------------------------------------------	------------

Other Practical Use Methods	P80
------------------------------------	------------

Other Information	P81
--------------------------	------------

1**2****3****4****5****6****7****8****9****10****11****12**

Table of Contents

Introduction	2
INDEX	3
Table of Contents	4
Safe and Proper Usage	6
General Precautions	7

1 Getting Started

Main Features	9
Identification of Parts	11
Inserting Batteries	13
Using the AC Adapter	14
Power Supply	15
HOLD	16
Setting Time/Date (Time&Date)	17
Notes on the Folders	19

2 About Recording

Before recording	23
Recording	25
Using the Variable Control Voice Actuator (VCVA)	28
Recording Modes (Rec Mode)	30
Microphone Sensitivity	31
Set the Low Cut Filter (LowCut Filter)	32

3 About Playback

Playing	34
Select Play Mode (Play Mode)	39
How to begin segment repeat playback ..	41
Noise Cancel Function (Noise Cancel) ...	43
Set the Voice Filter (Voice Filter)	45

4 Erase and other functions

Erasing	47
Index Marks and Temp Marks	50
Formatting the Recorder (Format)	52

5 Display and Sound Functions

LCD Display Information	55
Guidance (Voice Guide)	57

6 Menu Setting

Menu Setting Method	60
Menu List	62

7 Using the Recorder on Your PC

Saving Files in Your PC	65
Using DSS Player Software	67
Installing Software	69
Using Online Help	72
Connecting to Your PC	73
Running DSS Player	75

8 Managing Files on Your PC

Copying Voice Guide Data	76
--------------------------------	----

9 DSS Player Expanded Functions

Upgrade Function	77
------------------------	----

10 Importing Content for Listening on the Recorder

Importing Content for Listening on the Recorder	79
-------------------------------------------------------	----

11 Other Practical Use Methods

Using as External Memory of the Computer	80
------------------------------------------------	----

12 Other Information

Alarm Message List	81
Troubleshooting	82
Accessories (optional)	84
Specifications	85
Technical Assistance and Support	86

Safe and Proper Usage

Before using your new recorder, read this manual carefully to ensure that you know how to operate it safely and correctly. Keep this manual in an easily accessible location for future reference.

- The warning symbols indicate important safety related information. To protect yourself and others from personal injury or damage to property, it is essential that you always read the warnings and information provided.

Using the Online Manual

When you install the DSS Player on your PC from the CD-ROM, you can use an online expanded version of this instruction manual, allowing you to learn more about the digital voice recorder.

If the DSS Player is installed, click on the [Start] button, select [All Programs], then [OLYMPUS DSS Player], then click on [DS-50/40/30 ONLINE INSTRUCTIONS]. You can read more about the items listed below.

Recording from External Microphone or Other Devices	34
Timer Recording (Timer Rec)	36
Set Skip Space (Skip Space)	46
Changing the Playback Speed (Play Speed)	48
Alarm Playback Function (Alarm)	59
Locking Files (Lock)	68
Changing Folder Names (Folder Name)	70
Rearranging files (File Move)	72
Changing the USB Class (USB Class)	77

Changing Power Save (Power Save)	78
Changing External Input Setting (Ext. Input) ...	79
Viewing system information (System Info.)	81
Backlight (Backlight)	84
LED(LED)	85
LCD Contrast Adjustment (Contrast)	86
System Sounds (Beep)	90
Uninstalling Software	103
Window Names (DSS Player)	108
Download Voice Files from the Recorder ..	109
Play a Voice File	111
Upload Voice Files to the Recorder	112
Send Voice Files with E-mail	114
Changing User ID	114
Changing a Folder Name	115
Editing File Comments	115
Editing a Template	116
USB Microphone/USB Speaker	118
Using Voice Recognition Software	122
Joining Files	130
Splitting Files	132
Menu Setting of this Recorder	134
Using Windows Media Player	136
Window Names (Windows Media Player)	137
Copying Music from CD	138
Transferring Music File to the Recorder	139
Importing Podcast Content	142
Loading Audible Content	146
Transferring Audible Content	149
Enjoy Audible Content with the Recorder ...	151

General Precautions

- Do not leave the recorder in hot, humid locations such as inside a closed automobile under direct sunlight or on the beach in the summer.
- Do not store the recorder in places exposed to excessive moisture or dust.
- Do not use organic solvents such as alcohol and lacquer thinner to clean the unit.
- Do not place the recorder on top of or near electric appliances such as TVs or refrigerators.
- Avoid recording or playing back near cellular phones or other wireless equipment, as they may cause interference and noise. If you experience noise, move to another place, or move the recorder further away from such equipment.
- Avoid sand or dirt. These can cause irreparable damage.
- Avoid strong vibrations or shocks.
- Do not disassemble, repair or modify the unit yourself.

- Do not operate the unit while operating a vehicle (such as a bicycle, motorcycle, or go-cart).
- Keep the unit out of the reach of children.

<Warning regarding data loss>

Recorded content in memory may be destroyed or erased by operating mistakes, unit malfunction, or during repair work.

It is recommended to back up and save important content to other media such as a computer hard disk.

Any liability for passive damages or damage of any kind occurred due to data loss incurred by a defect of the product, repair performed by the third party other than Olympus or an Olympus authorized service station, or any other reasons is excluded from the Olympus's liability.

Batteries

Warning

- Batteries should never be exposed to flame, heated, short-circuited or disassembled.
- Do not attempt to recharge alkaline, lithium or any other non-rechargeable batteries.
- Never use any battery with a torn or cracked outer cover.
- Keep batteries out of the reach of children.
- If you notice anything unusual when using this product such as abnormal noise, heat, smoke, or a burning odor:
 - ① remove the batteries immediately while being careful not to burn yourself, and;
 - ② call your dealer or local Olympus representative for service.

AC Adapter

Warning

- Do not attempt to disassemble, repair or modify the AC adapter in any way.
- Keep foreign objects including water, metal, or flammable substances from getting inside the product.
- Do not moisten the AC adapter or touch it with a wet hand.
- Do not use the AC adapter in the vicinity of flammable gas (including gasoline, benzene and lacquer thinner).

In case

- ... the internal parts of the AC adapter are exposed because it has been dropped or otherwise damaged:
- ... the AC adapter is dropped in water, or if water, metal flammable substances or other foreign objects get inside it:
- ... you notice anything unusual when using the AC adapter such as abnormal noise, heat, smoke, or a burning odor:
 - ① do not touch any of the exposed parts;
 - ② immediately disconnect the power supply plug from the power outlet, and;
 - ③ call your dealer or local Olympus representative for servicing. Continued use of the AC adapter under these circumstances could result in electric shock, fire or injury.

Plus

The “DSS Player” can be upgraded to “DSS Player Plus”, which is equipped with enhanced functionality (paid option). (€P77)

Main Features

This product is equipped with the following features.

- This “IC recorder” is optimally suited for playing back audio recordings, such as conferences or business scenes, language studies, Podcasts, and other audible content. The recorder stores highly compressed WMA (Windows Media Audio) format voice messages in integrated flash memory. (P79)
It can also play back WMA and MP3 (MPEG-1/MPEG-2 Audio Layer-3) format files. (P34, 65)
- A exclusive remote control (supplied with the DS-50 only) can be attached to the recorder to control recording and stop operations. (P24)
- It uses a removable stereo microphone. (P23)
 - The stereo microphone can be removed when it is not necessary during playback, offering excellent portability.
 - If the stereo microphone is removed and attached to the exclusive remote control, it can be used as a remotely controlled stereo microphone.
 - Even if the stereo microphone is removed, the unit uses a built-in monaural microphone for recording.
- Several recording modes can be selected including stereo recording modes ST XQ (Stereo Extra High Quality Sound Recording) or ST HQ (Stereo High Quality Recording), and three types of monaural recording modes including HQ (High Quality), SP (Standard Recording), and LP (Long-term Recording). (P30)

Recording time

DS-50 (1GB)

ST XQ mode:	17hours30minutes
ST HQ mode:	35hours10minutes
HQ mode:	70hours20minutes
SP mode:	138hours30minutes
LP mode:	275hours20minutes

DS-40 (512MB)

ST XQ mode:	8hours40minutes
ST HQ mode:	17hours20minutes
HQ mode:	34hours45minutes
SP mode:	68hours30minutes
LP mode:	136hours15minutes

DS-30 (256MB)

ST XQ mode:	4hours10minutes
ST HQ mode:	8hours30minutes
HQ mode:	17hours00minutes
SP mode:	33hours30minutes
LP mode:	66hours40minutes

Available recording time may be shorter if many short recordings are made. (The displayed available recording time and recorded time are approximate indications.)

Maximum recording time per file

ST XQ mode:	26hours40minutes
ST HQ mode:	26hours40minutes
HQ mode:	26hours40minutes
SP mode:	53hours40minutes
LP mode:	148hours40minutes

A maximum recording time per file is set for each mode. Even if the recorder's memory is not used up, recording cannot be continued beyond the limit.

- This recorder is compatible with USB 2.0, enabling fast data transfer to a computer.

Main Features

- This USB storage class support recorder can be utilized as external memory to read and save the data. (P80)
 - By connecting the computer with the USB, pictures, text data, etc. can be saved, and utilized to carry data.
- It uses a high-contrast monochrome LCD (liquid crystal display) panel with a backlight with a background color whiter than conventional Olympus models.
- The guidance feature (in English and other languages) gives audio notification of operating conditions. It ensures seamless operation of various complex functions. (P57)
- You may assign your own names to folders.
- It has a built-in Variable Control Voice Actuator (VCVA) function. (P28)
- Timer Rec and Alarm features enable automatic recording and playing at a set time.
- The LowCut Filter minimizes air conditioner noise and other similar noises while recording. (P32)
- Index mark and temp mark features allow you to quickly find desired locations. (P50)
- The playback speed can be controlled as preferred.
- It features various repeat functions. (P39,41)
- A Noise Cancel Function (P43) and a Voice Filter Function (P45) cut noise and enable clear audio playback.
- Fast forward and rewind are possible at set intervals.
- Comes with DSS Player software. (P65)
 - If you transfer voice files recorded with the recorder to a PC, you can easily play back, organize, and edit the files.
 - If you connect the recorder to a computer, you can use it as a USB microphone or USB speaker.
- The “DSS Player” can be upgraded to a “DSS Player Plus”, which is equipped with an enhanced functionality (Option). (P77)
 - If a commercial voice recognition software is utilized, the recorded voice file can be converted to characters automatically.
 - In addition to the “DSS Player” functions, joining and splitting of the files and configuring the menu settings of this recorder, etc. can be performed.
- It is compatible with Podcasting.
 - If favorite Internet radio-station URLs are registered in the DSS Player, the latest broadcasting content will be received automatically. Press the Podcast button on the recorder to quickly listen to the program (file) transferred from the DSS Player to the recorder.
- Compatible with Audible broadcasting.

Identification of Parts

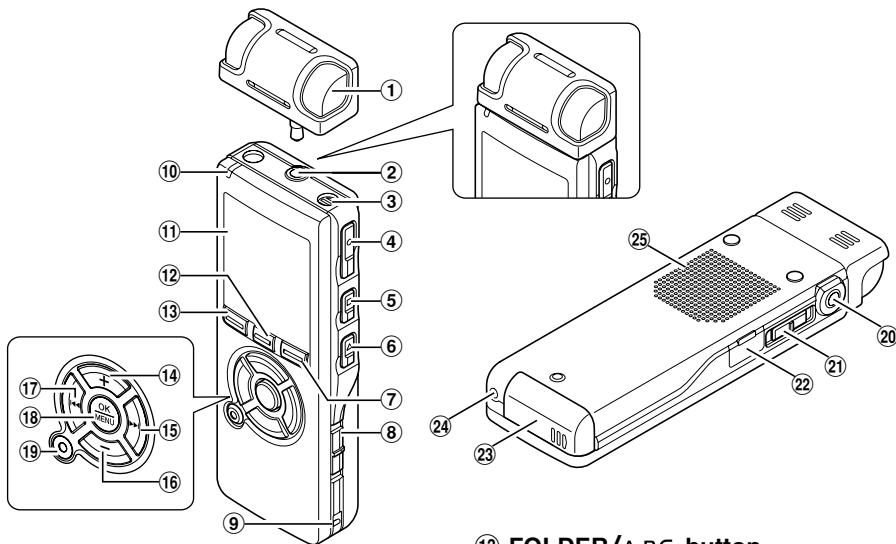

- ① Exclusive stereo microphone (ME53S)
- ② MIC (Microphone) / REMOTE jack
- ③ Built-in monaural microphone
- ④ REC (Record) button
- ⑤ STOP button
- ⑥ PLAY button
- ⑦ DISPLAY/Podcast button
- ⑧ POWER/HOLD switch
- ⑨ Strap hole
- ⑩ Record/Play indicator light (LED)
- ⑪ Display (LCD panel)
- ⑫ LIST/INDEX button

- ⑬ FOLDER/A-BC button
- ⑭ VOLUME (+) button
- ⑮ ►► (Fast Forward) button
- ⑯ VOLUME (-) button
- ⑰ ◀◀ (Rewind) button
- ⑱ OK/MENU button
- ⑲ ERASE button
- ⑳ EAR (Earphone) jack
- ㉑ MIC SENSE (Microphone Sensitivity) switch
- ㉒ PC (USB) terminal
- ㉓ Battery cover
- ㉔ Power jack
- ㉕ Built-in speaker

Remote Controller (RS29 supplied with the DS-50 only)

Recording and stop operations can be performed by connecting the remote controller to the recorder. The remote controller can also be used as a remote controlled stereo microphone by connecting it to the exclusive stereo microphone (ME53S).

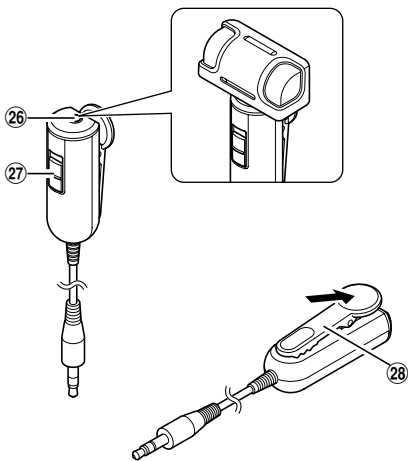

- 26 MIC (Microphone) jack
- 27 REC/STOP switch
- 28 Clip

Display (LCD Panel)

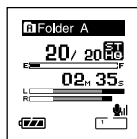
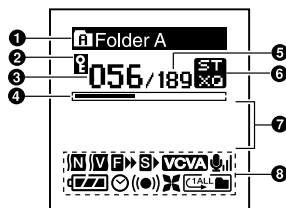

Display in the stereo recording mode

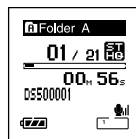

Display in the playback mode

- 1 Folder name indicator
- 2 Erase lock indicator
- 3 Current file number
- 4 Play position bar indicator
- 5 Total number of recorded files in the folder
- 6 Record mode indicator
- 7 Character information display
- 8 Icon display
- Noise Cancel indicator
- Voice Filter indicator
- F. Play indicator
- S. Play indicator
- VCVA (Variable Control Voice Actuator) indicator
- Microphone sensitivity indicator
- Battery indicator
- Timer indicator
- Alarm indicator
- Low Cut Filter indicator
- Play Mode indicator

Inserting Batteries

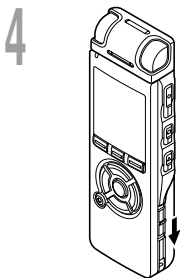
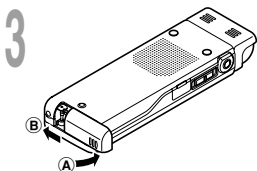
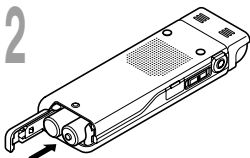
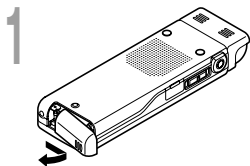

1 Lightly press down on the arrow and slide the battery cover open.

2 Insert two AAA alkaline batteries, observing the correct polarity.

3 Close the battery cover completely by pressing to the direction (A), then sliding to the direction (B).

4 Slide the **POWER/HOLD** switch in the direction indicated by the arrow, and turn the power on.

If the “hour” indicator flashes in the display, see “Setting Time/Date (Time&Date)” (P17).

Replacing batteries

The battery indicator on the display changes as the batteries lose power.

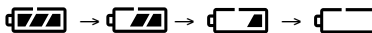

When  appears on the display, replace the batteries as soon as possible.

When the battery is too weak,  “Battery Low” appears on the display and the recorder shuts down. When changing batteries, AAA alkaline batteries or Olympus Ni-MH batteries (P14) are recommended.

Ni-MH Rechargeable Battery

Optional Ni-MH rechargeable batteries from Olympus can be used in the recorder. Use them with the BU-400 Olympus Ni-MH Rechargeable Battery Charger (Europe only). (P84)

Notes

- **Be sure to stop the recorder before replacing the batteries.** Unloading the batteries while the recorder is in use may corrupt the file. If you are recording into a file and the batteries run out, you will lose your currently recorded file because the file header will not be able to close. It is crucial to change the batteries once you see only one Hash mark in the battery icon.
- If it takes longer than 1 minute to replace dead batteries, you may have to reset the time when you load fresh batteries (P17).
- Remove the batteries if you are not going to use the recorder for an extended period of time.

Using the AC Adapter

Plug the optional AC adapter (Olympus Model A321 or A322) into a household power outlet and connect the power plug to the recorder's power connector (DC 3V). Always turn the recorder's power off or stop recording before connecting. If the AC adapter is plugged in while recording using batteries, it may not be possible to play back the voice data being recorded.

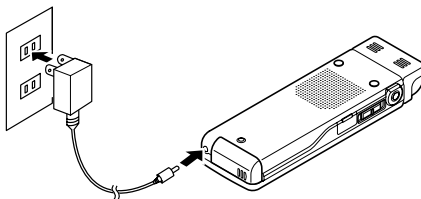

Warning

- **Always stop recording before connection or disconnection.**
- **When the AC adapter is not in use, disconnect the power supply plug from the power outlet.**
- **Use only the correct power supply voltage as indicated on the adapter.**
- **Do not use the AC adapter when connecting the recorder to the USB port.**

Power Supply

When the recorder is not being used, turn the power off to reduce battery consumption to a minimum. Even if the power is turned off, existing data, mode settings, and clock settings will be maintained.

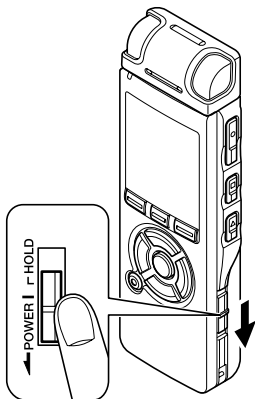

Turning On the Power

While the recorder's power is off, slide the **POWER/HOLD** switch in the direction indicated by the arrow.

The display will turn on, and, after "System Check" appears, the power will be turned on. The resume function will bring the recorder back to the stop position in memory before power was turned off.

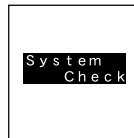

Turning Off the Power

Slide the **POWER/HOLD** switch in the direction indicated by the arrow for **0.5 seconds or longer**.

The display shuts off and the power will be turned off. The resume function remembers the stop position before the power is turned off.

Power save mode

If the recorder is on and stops for 10 minutes or longer (default), the display shuts off and it goes into power save mode. You can set the time to enter power save mode from among "5 min," "10 min," "30 min," "1 hour," and "Off." To exit power save, press any button.

HOLD

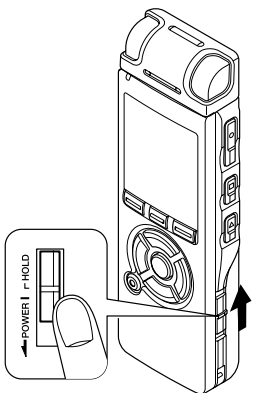

If you bring the POWER/HOLD switch to the HOLD position, the current conditions will be preserved, and all buttons and switches will be disabled. This feature is useful when the recorder has to be carried in a bag or pocket.

Set the recorder to HOLD mode

Slide the **POWER/HOLD** switch to the **HOLD** position.

After “Hold” appears on the display, the recorder is set to HOLD mode.

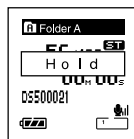

Exit HOLD mode

Slide the **POWER/HOLD** switch to the **(A)** position.

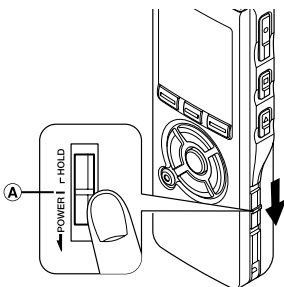

Notes

- If you press any button in HOLD mode, the clock display flashes for 2 seconds, but it will not operate the recorder.
- If HOLD is applied during playback (recording), operation is disabled with the playback (recording) state unchanged. (When playback has ended and the recording has ended due to the remaining memory being used up, it will stop.)
- Even if the recorder is in HOLD mode, operations using the remote control are still available.

Setting Time/Date (Time&Date)

If you set the date and time beforehand, the information when the file is recorded is automatically stored for each file. Setting the date and time beforehand enables easier file management.

When you use the recorder for the first time after purchasing it, or turn the power on after having removed the batteries for one minute or longer to change them or for other purposes, the “Set Time & Date” message will appear. If the “Hour” indicator flashes, follow the steps below to set it.

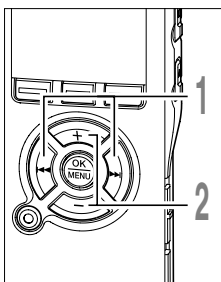
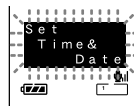

1 Press the ►►► or ◀◀◀ button to select the item to set.

Select the item from “hour”, “minute”, “year” “month” and “day” with a flashing point.

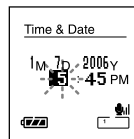

2 Press the + or - button to set.

Follow the same steps by pressing the ►►► or ◀◀◀ button to select the next item, and press the + or - button to set.

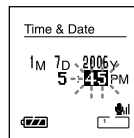

- You can choose between 12 and 24 hour display by pressing the DISPLAY button while setting the hour and minute.

Example: 5:45 P.M.

5:45 PM ↔ 17:45
(Initial setting)

- You can choose the order of the year, month, day by pressing the DISPLAY button while setting them.

Example: January 14, 2006

1M 14D 2006Y → 14D 1M 2006Y → 2006Y 1M 14D
(Initial setting)

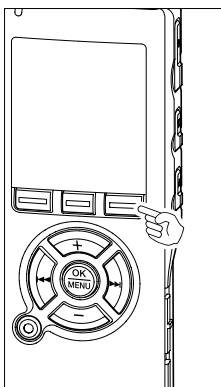

Setting Time/Date (Time&Date)

1

Setting Time/Date

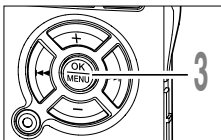

- 3 Press the OK button to complete the setup screen.**
The clock will start from the set date and time. Press the OK button according to the time signal.

Notes

- If you press the OK button during the setup operation, the recorder will save the items that were set to that point.
- After setup, a message will sound saying that if the guidance is not required, select "Off", and the screen goes into "Voice Guide" setup (P57). If you don't want the guidance feature, select "Off".

Changing the Time/Date

Press the STOP button while the recorder has stopped recording to check "Time & Date" and "Remain". If the "Time & Date" is not correct, set it using the procedure below.

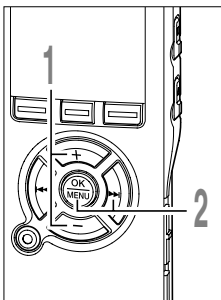

- 1 Press the + or - button in the menu screen, and select the "Time&Date".**

See P60, 62 regarding the menu.

- 2 Press the OK or ►►► button.**

The Time/Date screen appears. The hour indicator flashes, indicating the start of the Time/Date setup process. The following steps are the same as Step 1 through Step 3 of "Setting Time/Date (Time&Date)". (P17)

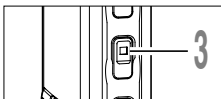
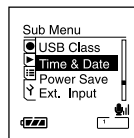

- 3 Press the STOP button to close the menu.**

Notes on the Folders

There are a total of eight folders in the recorder that are in a tree format. Under the “Root” folder are “Folder A” through “Folder E”, “Audible” and “Music” folders, and recorded or transferred language and music data from a computer can be saved as “files”. “Folder A” through “Folder E” are voice-recording folders, so choose one of these five folders when recording on this recorder.

Up to 200 files can be saved in each folder, and up to two layers can be created within the “Music” folders.

“Audible” folder can be purchased from an Audible web site by using the “Audible Manager”, and files transferred to the recorder are saved in this folder (in ACELP/MP3 format).

A “Podcast” folder, for saving files distributed by Podcasting, is prepared in advance inside the “Music” folder.

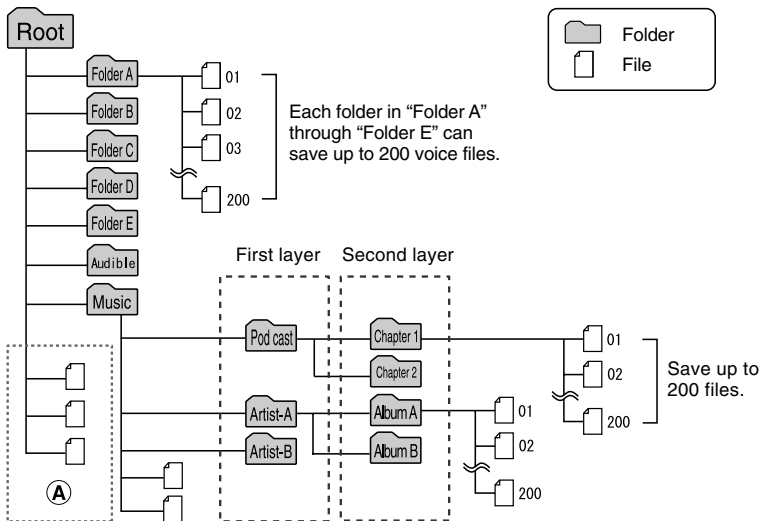

Notes

- Up to 128 folders can be created under the “Music” folder including “Music” and “Podcast”.
- When using Windows Media Player 10, click [Start Sync] instead of setting the synchronization options. All the files will be transferred to the part (A) above.
- It is not possible to create a folder in the “Audible” folder.

Selecting the Folders and Files

List display

The folders and files recorded in this recorder are displayed.

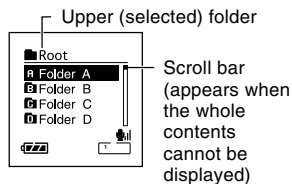

File display

Information of the selected file is displayed. Enters in playback standby mode.

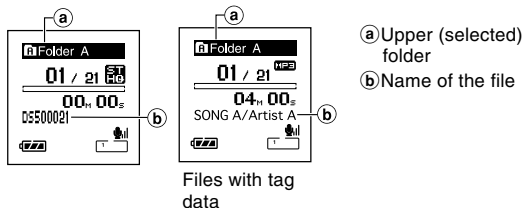

Press the FOLDER button to switch folders

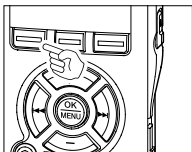

Press the **FOLDER** button while the recorder is stopped.

- Every time the Folder button is pressed, it cycles through “Folder A” through “Folder E” and the “Audible” “Music” folder, and it shows a list of files and folders recorded within each folder.

When the “Audible” folder is opened, the recorder enters the Audible mode.

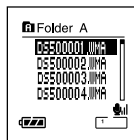

Open the “Podcast” folder

While the recorder is stopped, press the **Podcast** button for one second or longer.

- If the “Podcast” folder under the “Music” folder is opened, a list of files and folders within the folder will appear. For “Podcast” please see Online manual.

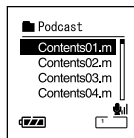

How to select a folder and file

You can select a desired folder and file even without using the Folder button or the Podcast button.

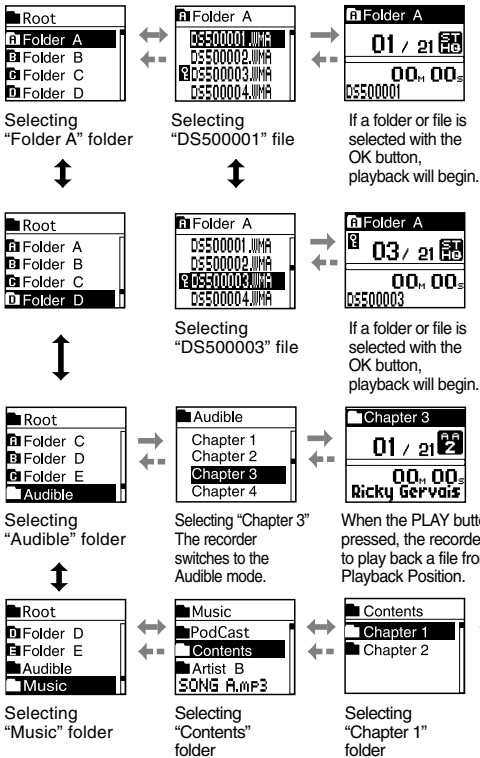

↑ ↓ **+ or - button:** Moves the cursor up and down.

→ ▶▶ **or OK button:** Opens the selected folder/file.

← ◀◀ **button:** Returns to the upper folder.

◀◀ **LIST button:** Returns to the upper folder while in the list display, and returns to the list display while in the file display.

* You can also start playing back a file by pressing the Play button while a list of files is on display.

File names will be automatically created for files recorded by this recorder.

DS50 0001.WMA

Extension

File number : A serial number automatically assigned by a Digital Voice Recorder.

User ID : The name that has been set on the Digital Voice Recorder. The default name on the Digital Voice Recorder is "DS-50" , "DS-40" or "DS-30" . The user ID can be modified with DSS Player.

Before recording

This recorder offers a wide range of recording options by using the exclusive stereo microphone, built-in monaural microphone, and exclusive remote control (provided with the DS-50 only). Choose a recording method according to your need.

Stereo recording using the exclusive stereo microphone

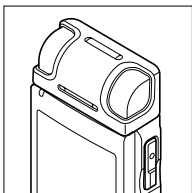

Plug the exclusive stereo microphone into the recorder's MIC/REMOTE jack for stereo recording in ST XQ and ST HQ modes and monaural recording in HQ, SP, and LP modes.

Connect the exclusive stereo microphone to the recorder's MIC/REMOTE jack.

Monaural recording with the built-in microphone

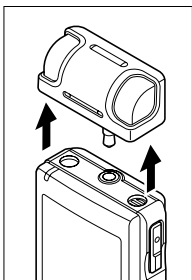

Even if the exclusive stereo microphone is unplugged, recordings can be still made using the recorder's built-in microphone.

Unplug the exclusive stereo microphone from the recorder.

Notes

- If a recording is made in ST XQ and ST HQ modes while the exclusive stereo microphone is unplugged, it will be a monaural recording through the built-in microphone, and same audio will be recorded on both Left channel (Lch) and Right channel (Rch).
- Stop the recorder before plugging in or unplugging a microphone.

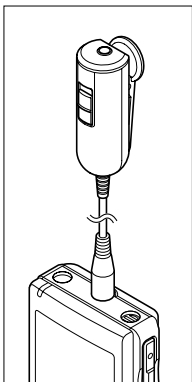

Use the remote control for operation

Plug the exclusive remote control into the recorder's MIC/REMOTE jack to use the remote control to operate the recorder.

Connect the exclusive remote control to the recorder's MIC/REMOTE jack.

- ➡ Use the REC/STOP switch on the exclusive remote control to start and stop recording with the recorder's built-in microphone (☞ P25).

Notes

- Even when the exclusive remote control is plugged in, the recorder's buttons are still usable.
- Even when the recorder is in Hold mode (☞ P16), the exclusive remote control's REC/STOP switch is still usable.
- When the switch of the exclusive remote control is set to STOP and the REC button on the recorder is pressed, the recorder starts recording with the microphone that has been connected to the exclusive remote control. Recording will not be made if a microphone is not connected to the exclusive remote control.

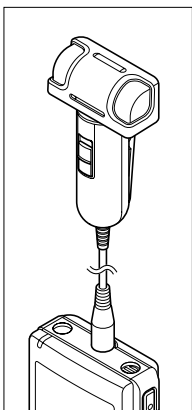

Use it as a remotely controlled stereo microphone

If the exclusive stereo microphone is removed from the recorder and plugged into the exclusive remote control's Mic jack, it can be used as a remotely controlled stereo microphone.

Connect the exclusive stereo microphone to the exclusive remote control's Mic jack.

- ➡ Use the REC/STOP switch on the exclusive remote control to start and stop recording on the recorder (☞ P25).

Notes

- Even when the exclusive remote control is plugged in, the recorder's buttons are still usable.
- Turn the exclusive remote control's switch to Stop and press the recorder's REC button to start and stop recording using the remote-control stereo microphone.

Recording

Before starting recording, select a folder between Folder **A** to Folder **E**. These five folders can be selectively used to distinguish the kind of recording; for example, Folder **A** might be used to store private information, while Folder **E** might be dedicated to holding business information. Newly recorded audio will be saved as the last file in the selected folder.

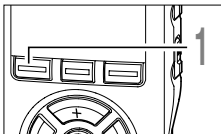

1 Press the **FOLDER** button to choose a folder in which to make a recording.

Every time the FOLDER button is pressed, folders will switch (☞ P20).

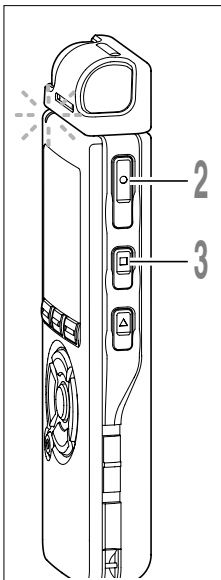

2 Press the **REC** button to start recording.

The record/play indicator light glows red. Turn the microphone in the direction of the source to be recorded. The display changes depending on the recording mode (☞ P30). When the exclusive remote control is connected, the remote control's REC/STOP switch will work the same as the recorder's REC and STOP buttons.

- a **Current recording mode**
- b **Recording elapsed time**
- c **Memory remaining indicator (E/F bar)**
(The bar indicates remaining memory)
- d **Level meter** (varies according to the sound volume being recorded)

Every time the Display button is pressed while recording, “Recording elapsed time” and “Remaining recording time” cycles in the location indicated by b).

3 Press the **STOP** button to stop recording.

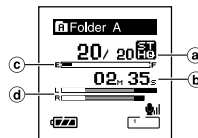
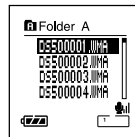

Display in the stereo recording mode

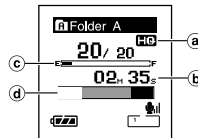

Display in the monaural recording mode

2

Recording

Notes

- If you select a folder other than **A** through **E** and press the REC button, an “Illegal Folder” message will flash. Select a folder from **A** through **E** and start recording again.
- To ensure recording from the beginning, start speaking after you see the red record/play indicator light on.
- A beep will sound when remaining recording time reaches 60 seconds, 30 seconds, and 10 seconds while recording.
- When remaining recording time is less than 60 seconds, the record/play indicator light starts flashing in red. When the recording time is decreasing to 30 or 10 seconds, the light flashes faster.
- “Memory Full” or “Folder Full” will be displayed when the memory or folder capacity is full. Delete any unnecessary files before recording any further (see P.47).

Pause



Press the **REC** button while recording.

➔ “Rec Pause” will flash on the display.

- The recorder will time out after 2 hours when left in “Rec Pause”.

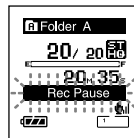

Resume Recording

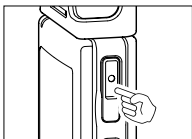

Press the **REC** button again.

➔ Recording will resume at the point of interruption.

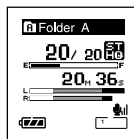

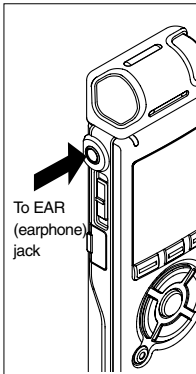

Listening While Audio is Recorded

If you start recording after inserting the earphone into the EAR jack on the recorder, you can hear the sound being recorded. The sound volume on the recording monitor can be adjusted by pressing the VOLUME (+) or VOLUME (-) button.

Connect the earphone to the EAR jack on the recorder.

- After recording has started, you can hear the sound being recorded through the earphone. If the earphone is connected, no sound will come from the speaker.

Notes

- Recording level cannot be controlled using the volume button.
- When using the earphones, do NOT set the volume too high. Listening at very high volume may lead to hearing loss.
- Do not place earphones near a microphone as this may cause feedback.

Using the Variable Control Voice Actuator (VCVA)

When the microphone senses that sounds have reached a preset threshold volume level, the built-in Variable Control Voice Actuator (VCVA) starts recording automatically, and stops when the volume drops below the threshold level.

The VCVA feature extends recording time and conserves memory by stopping recording during silent periods, which helps the playback to be more efficient.

2

Using the Variable Control Voice Actuator

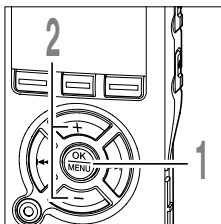

- 1 While the recorder is stopped or during recording, press the **MENU** button for 1 second or longer.

The menu opens. (P60, 62)

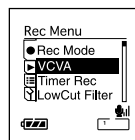

- 2 Press the **+** or **-** button to choose "VCVA".

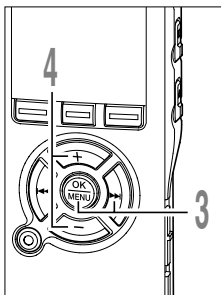

- 3 Press the **OK** or **▶▶** button.

The VCVA setup process begins.

- 4 Press the **+** or **-** button to choose between "On" and "Off".

On: Will start recording in VCVA mode.

Off: Will resume recording in normal mode.

When "On" is selected, a VCVA indication will be displayed on the screen.

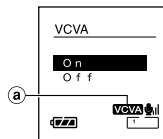

- a **VCVA (Variable Control Voice Actuator)** indicator

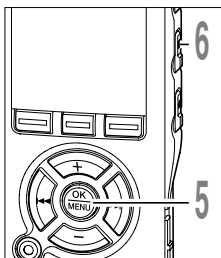

- 5 Press the **OK** button to complete the setup screen.

If the **◀◀** button is pressed, the setting will be canceled and it will return to the menu.

- 6 Press the **STOP** button to close the menu.

If it returns to the menu screen during recording, press the **◀◀** button to close the menu screen.

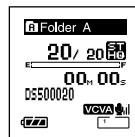

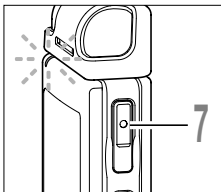

7 Press the REC button to start recording.

When the sound volume is lower than the preset threshold sound level, recording automatically stops after 1 sec approximately, and “Standby” flashes on the display. The record/play indicator light glows red when recording starts and flashes when recording pauses.

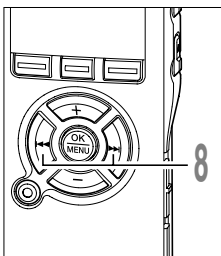
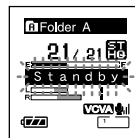

8 Press the ►► or ◀◀ button adjust the pause sound level.

The VCVA level can be set to any of 15 different values. The higher the value, the more sensitive the recorder to sounds. At the highest value, even the faintest sound will activate recording.

The VCVA pause sound level can be adjusted according to the ambient (background) noise.

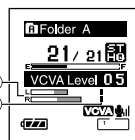

- ⓑ **Level meter** (varies according to the sound volume being recorded)
- ⓒ **Start level** (moves to the right/left according to the set level)

Notes

- The start/stop actuation level also varies depending on the selected microphone sensitivity mode (P31).
- If the surrounding noise is loud, the starting sensitivity of the VCVA can be adjusted according to the recording situation.
- To ensure successful recordings, prior testing and adjustment of the start/stop actuation level is recommended.

Recording Modes (Rec Mode)

The recording mode can be chosen from ST XQ (stereo extra high quality sound recording), ST HQ (stereo high quality sound recording), HQ (high quality sound recording), SP (standard recording), and LP (long-term recording).

2

Recording Modes

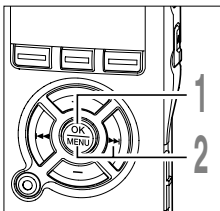

- 1 While the recorder is stopped, press the MENU button for 1 second or longer.**
“Rec Mode” will be displayed on the screen.
(P60, 62)

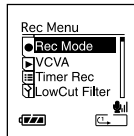

- 2 Press the OK or ►► button.**
The recording mode setup process begins.

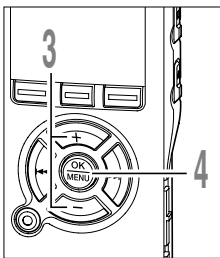

- 3 Press the + or - button to choose from “ST XQ”, “ST HQ”, “HQ”, “SP” and “LP”.**

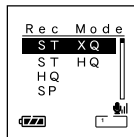

- 4 Press the OK button to complete the setup screen.**
If the ◀◀ button is pressed, the setting will be canceled and it will return to the menu.

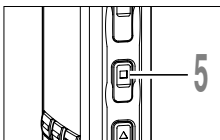

- 5 Press the STOP button to close the menu.**
a Record mode indicator

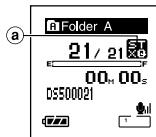

Press the STOP button while the recorder is stopped to check “Remaining Memory” and “Remaining Recording Time” in the selected recording mode.

Microphone Sensitivity

Microphone sensitivity is adjustable to meet recording needs.

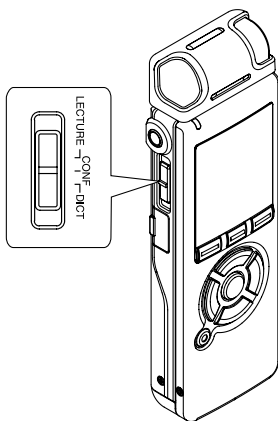

While the recorder is stopped or during recording, slide the Mic Sense switch and select a microphone sensitivity among “LECTURE”, “CONF”, and “DICT”.

Every time the setting is switched, it cycles through the display's microphone sensitivities.

LECTURE (🗣️): Highest recording sensitivity suitable for conferences with large crowds and recording audio at a distance or low volume.

CONF (🗣️): Suitable for recording meetings and seminars with a small number of people.

DICT (🗣️): Lowest recording sensitivity suitable for dictation.

Ⓐ Microphone sensitivity display

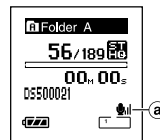

2

Microphone Sensitivity

Notes

- When the speaker's voice is to be recorded clearly, set it to DICT (dictation) mode. If breath directly hits the microphone it will be noisy, so keep the microphone a little lower than the speaker's mouth (5 to 10cm/2 to 4 inches) while recording.
- If the ambient (background) noise is too loud to get a clear recording even in DICT (dictation) mode, we recommend that you use an ME12 Noise-Cancellation monaural microphone. (sold separately. ☎P84)

Set the Low Cut Filter (LowCut Filter)

The recorder has a Low Cut Filter function to minimize low-frequency sounds and record voices more clearly. This function can reduce noise from air conditioners, projectors and other similar noises.

2

Set the Low Cut Filter

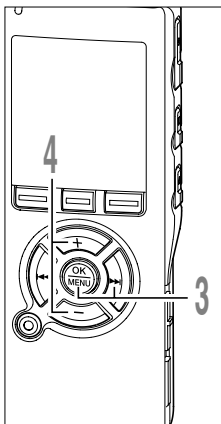
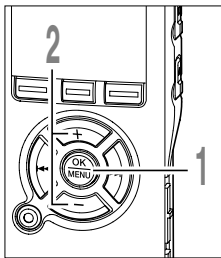

- 1 While the recorder is stopped or during recording, press the **MENU** button for 1 second or longer.

The menu opens. (P60, 62)

- 2 Press the **+** or **-** button to choose “LowCut Filter”.

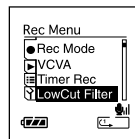

- 3 Press the **OK** or **▶▶▶** button.

The Low Cut Filter setup process begins.

- 4 Press the **+** or **-** button to choose between “On” and “Off”.

On: Low Cut Filter will be turned on.

Off: Low Cut Filter will be cancelled.

If it goes to the menu screen during recording, move the cursor and the Low Cut Filter will be turned On/Off according to the movement so you can check the effect with the recording monitor. (P27)

If it is set to “On”, **✖** will appear on the display.

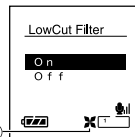

- a** Low Cut Filter indicator

Set the Low Cut Filter (LowCut Filter)

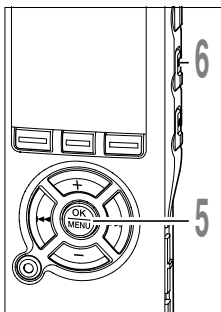

5 Press the **OK** button to complete the setup screen.

If the **◀◀** button is pressed, the setting will be canceled and it will return to the menu.

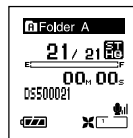

6 Press the **STOP** button to close the menu.

If it returns to the menu screen during recording, press the **◀◀** button to close the menu screen.

2

Set the Low Cut Filter

Recommended settings by recording condition

Recording condition	Recommended settings			
	Microphone	Recording Modes	Microphone Sensitivity	Low Cut Filter
Conferences with large crowds and lectures in large rooms	Exclusive stereo microphone (ME53S)	STXQ	LECTURE	On
Meetings and business negotiations with a small number of people		STXQ, STHQ	CONF	
Dictation with a lot of background noise		STXQ, STHQ, HQ	DICT	
Music playing, wild birds singing, and railway sounds		STXQ	Microphone Sensitivity ^{*1}	Off
Dictation in a quiet environment	There is no particular recommendation. Choose a setting for recording.			

*1: Set the microphone sensitivity according to the volume being recorded.

Playing

The recorder can play back WMA and MP3 format files. To play back a file recorded with other machines, you need to transfer (copy) it from a computer. Files saved in the Audible folder can play back in the Audible mode. For operation methods in the Audible mode, see Online manual.

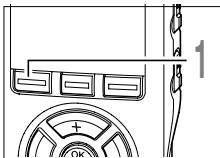

1 Press the **FOLDER** button to choose a folder.

Every time the FOLDER button is pressed, it cycles through folders and the List display will appear. (☞P20)

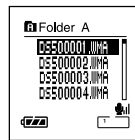

List display

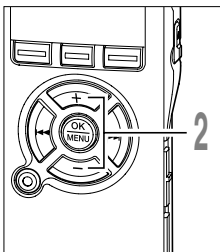

2 Press the **+** or **-** button to choose the file that you want to play.

If the ►►| button is pressed, the File display will open.

In the File display, press the ►►| or |◀◀ button to select a file.

If you want to return from the File display to the List display, or go back from the List display to a higher-level List display, press the LIST button.

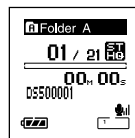

File display

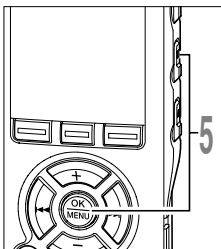
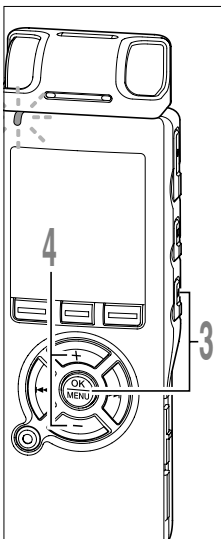

3 Press the **PLAY** or **OK** button to start playback.

The record/play indicator light glows green.
For files created using machines other than this recorder, the file format will appear on the display.

MP3MP3 files

WMAWMA files

- a Play position bar indicator
- b Current playback time
- c File name
- d File format indicator

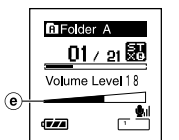
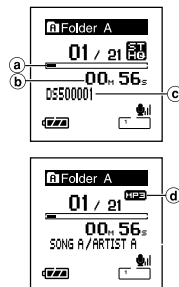

4 Press the **+** or **-** button to select the proper sound volume.

The display shows the volume level. You can choose between 0 and 30.

- e Volume level meter

5 Press the **STOP** or **OK** button at any point you want to stop the playback.

Stop a file play back at any point.

Press the PLAY or OK button to start playing back from where it was stopped.

You can change the display patterns (P55). The displays indicated in this manual are default.

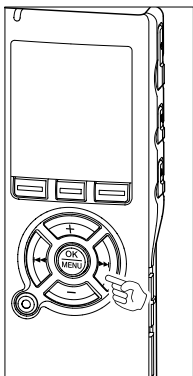

Forwarding

Press and hold the **FF** button while the recorder is stopped.

➤ If you release the button, it will stop. Press the **PLAY** or **OK** button to start playing back from where it was stopped.

a File length

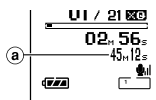

Press and hold the **FF** button while playing a file.

➤ When you release the **FF** button the recorder will resume normal playback.

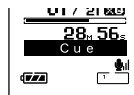

- If there is an index mark or temp mark (P50) in the middle of the file, the recorder will stop at that location.
- The recorder stops when it reaches the end of the file. Continue pressing the **FF** button to proceed with the cue from the beginning of the next file.

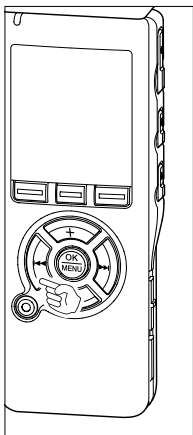

Rewinding

Press and hold the **RR** button while the recorder is stopped.

➤ If you release the button, it will stop. Press the **PLAY** or **OK** button to start playing back from where it was stopped.

a File length

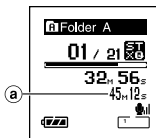

Press and hold the **RR** button while playing a file.

➤ When you release the **RR** button the recorder will resume normal playback.

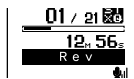

- If there is an index mark or temp mark (P50) in the middle of the file, the recorder will stop at that location.
- The recorder stops when it reaches the beginning of the file. Continue pressing the **RR** button to proceed with the review from the end of the previous file.
- If the **RR** button is kept pressed while the recorder is stopped at the start of the top file, the recorder will fast rewind starting from the end of the last file.

Locating the Beginning of the File



Press the ▶▶ button during playback, slow playback, or fast playback.

- The next file is cued and playback starts at the previously set speed.



Press the ◀◀ button during playback, slow playback, or fast playback.

- The file being played is cued and playback starts at the previously set speed.*



Press the ◀◀◀◀ button 2 times during playback, slow playback or fast playback.

- The previous file is cued and playback starts at the previously set speed.*

- If there is an index mark or temp mark (P50) in the middle of the file, the recorder will stop at that location.

* If the skip space is set at other than file skip, the recorder will F. Skip (forward skip) or R. Skip (reverse skip) for a set time before playback.

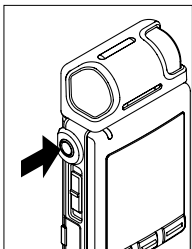

Playback Through Earphone

An earphone can be connected to the EAR jack of the recorder for listening.

- When the earphone is used, the recorder speaker will be switched-off.

.....

Notes

- To avoid irritation to the ear, insert the earphone after turning down the volume level.
- When you listen with the earphone during playback, do not raise the volume too much. It may cause hearing impairment and decrease in hearing ability.

Select Play Mode (Play Mode)

There are six play modes. You can choose whether to play by file or folder, or all files stored in the recorder.

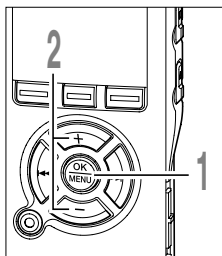

- 1** While the recorder is stopped or during playback, press the **MENU** button for 1 second or longer.

The menu opens. (P60, 62)

- 2** Press the **+** or **-** button to choose “Play Mode”.

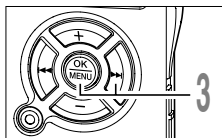
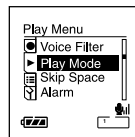

- 3** Press the **OK** or **▶▶▶** button.
Start setting a play mode.

a Current play mode

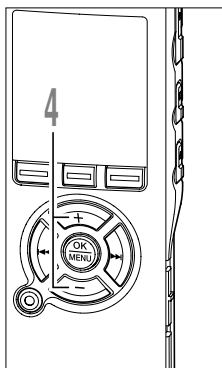
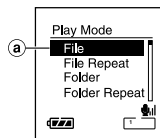

- 4** Press the **+** or **-** button to select a desired play mode.

File (T): Stop after playing back the current file.

File Repeat (T): Play the current file repeatedly.

Folder (T): Play files continuously in the current folder until the last file and stop.

Folder Repeat (T): Play all files in the current folder continuously.

All (T): Play all files in the recorder continuously and stop.

All Repeat (T): Play all files in the recorder continuously and repeatedly.

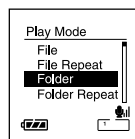

Select Play Mode (Play Mode)

3

Select Play Mode

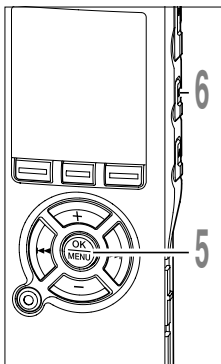

5 Press the **OK** button to complete the setup screen.

If the **◀◀** button is pressed, the setting will be canceled and it will return to the menu.

6 Press the **STOP** button to close the menu.

If the recorder goes to the menu screen during playback, press the **◀◀** button to close the menu screen.

An icon will appear on the display according to the setting.

b Selected play mode

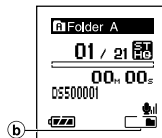

Notes

- In "File" mode, when the recorder comes to the end of the last file in the folder, "End" flashes for two seconds on the display and the recorder stops at the start of the last file.
- In "Folder" mode, when the recorder comes to the end of the last file in the folder, "End" flashes for two seconds on the display and the recorder stops at the start of the first file in the folder.
- In "All" mode, after playing the last file in the folder, the recorder will start playing from the first file in the next folder. When it comes to the end of the last file in the recorder, "End" flashes for two seconds on the display and the recorder stops at the start of the first file in the recorder.

How to begin segment repeat playback

This function enables repeated playback of part of the file being played.

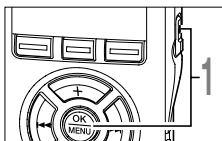

- 1 Choose a file that contains a segment you want to play back repeatedly, and press the **PLAY** or **OK** button.**

File playback begins.

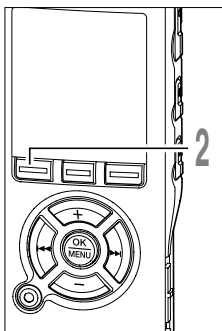
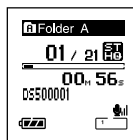

- 2 Press the **A-B-C** button at the point you want to start segment repeat playback.**

“↶End?” will flash on the display.

Even while “↶End?” is flashing, changing the playback speed, fast forward and rewind (P36) can be executed the same as during normal playback, and it can be advanced quickly to the end position. When it reaches the end of the file while “↶End?” is flashing, the point will become the end position, and repeat playback will start.

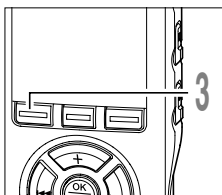
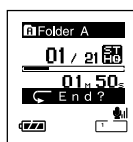

- 3 Press the **A-B-C** button again at the position where you want to end segment repeat playback.**

The “↶Play” message appears, and repeat playback will start. The recorder repeatedly plays back the segment until the segment repeat playback is canceled.

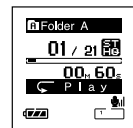

3

How to begin segment repeat playback

As in regular play mode, playback speed can be changed during segment repeat playback as well. If an index mark and temp mark (P36) are inserted or eliminated during segment repeat playback, segment repeat playback will be canceled and it will return to regular play mode.

Cancel the Segment Repeat Playback Function

Press the **OK** button.

- Pressing the OK button will release segment repeat playback and stop playback.

Press the **STOP** button.

- Pressing the STOP button will release segment repeat playback and stop playback.

Press the **▶▶|** button.

- Pressing the ▶▶| button will release segment repeat playback and fast forward and cue to the beginning of the next file.

Press the **|◀◀** button.

- Pressing the |◀◀ button will release segment repeat playback and rewind and reverse to the beginning of the current file.

Press the **A-BC** button.

- The segment repeat playback is released and playback continues without repeating.

Noise Cancel Function (Noise Cancel)

If recorded audio is difficult to understand because of noisy surroundings, adjust the Noise Cancel setting level. Noise will be reduced in the file when it's played back for better sound quality.

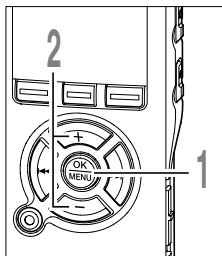

- 1 While the recorder is stopped or during playback, press the MENU button for 1 second or longer.**

The menu opens. (P60, 62)

- 2 Press the + or - button to choose "Noise Cancel".**

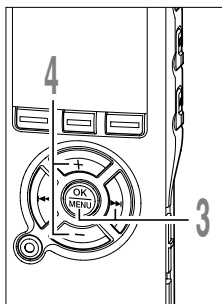
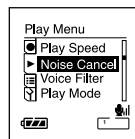

- 3 Press the OK or >>> button.**

The noise cancel setup process begins.

- 4 Press the + or - button to choose between "High" "Low" and "Off".**

The levels switch in the following rotation, "High" "Low" "Off". If the recorder goes to the menu screen during playback, move the cursor to change playback sound accordingly.

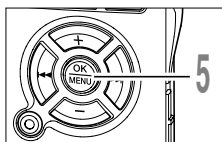
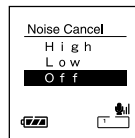

- 5 Press the OK button to complete the setup screen.**

If the <<< button is pressed, the setting will be canceled and it will return to the menu.

Noise Cancel Function (Noise Cancel)

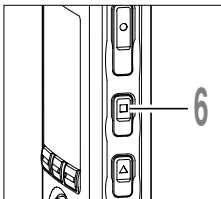

6 Press the **STOP** button to close the menu.

If the recorder goes to the menu screen during playback, press the **◀◀** button to close the menu screen.

The **N** will appear on the display.

a **Noise Cancel indicator**

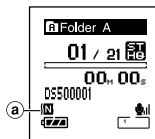

3

Noise Cancel Function

Notes

- If you set Noise Cancel to "Low" or "High", the setting remains valid until it's set to "Off".
- Noise cancel cannot be used during fast playback/slow playback.
- Noise Cancel is not available while the Voice Filter (P45) is set.

Set the Voice Filter (Voice Filter)

The recorder has a Voice Filter Function to cut low and high frequency tones during normal, fast, or slow playback, and enable clear audio playback.

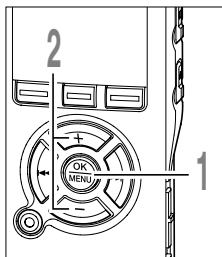

- 1** While the recorder is stopped or during playback, press the **MENU** button for 1 second or longer.

The menu opens. (P60, 62)

- 2** Press the **+** or **-** button to choose “Voice Filter”.

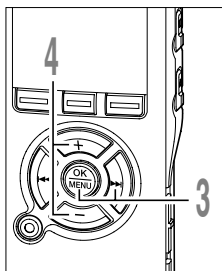
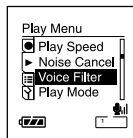

- 3** Press the **OK** or **▶▶** button.

The voice filter setup process begins.

- 4** Press the **+** or **-** button to choose between “On” and “Off”.

On: Voice Filter will be turned on.

Off: Voice Filter will be canceled.

If the recorder goes to the menu screen during playback, move the cursor to change playback sound accordingly.

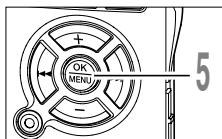
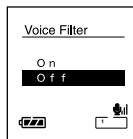

- 5** Press the **OK** button to complete the setup screen.

If the **◀◀** button is pressed, the setting will be canceled and it will return to the menu.

3

Set the Voice Filter

Set the Voice Filter (Voice Filter)

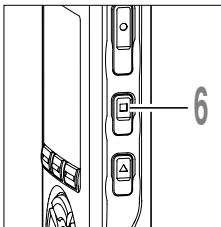

6 Press the **STOP** button to close the menu.

If the recorder goes to the menu screen during playback, press the **◀◀** button to close the menu screen. If it is set to “On”, **VF** will appear on the display.

a Voice Filter indicator

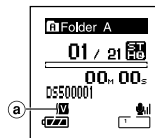

3

Set the Voice Filter

Note

- Voice Filter is not available while Noise Cancel is set.

Erasing

Erasing One File at a Time

A selected file can be erased from a folder.

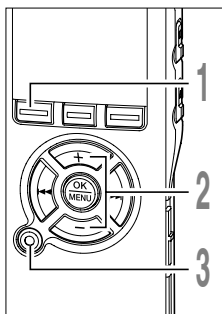

- 1 Press the FOLDER button to choose a folder.**

Every time the FOLDER button is pressed, it cycles through folders and the List display will appear (see P20).

- 2 Press the + or - button to choose the file you want to erase.**

- 3 Press the ERASE button.**
The “Cancel” indicator flashes.

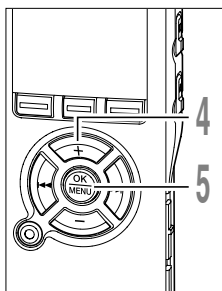

- 4 Press the + button to choose “Erase”.**

- 5 Press the OK button.**
The display changes to “File Erase!” and erasing will start.

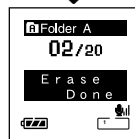
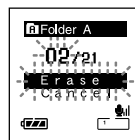
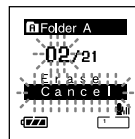

“Erase Done” is displayed when the file is erased. File numbers will be reassigned automatically.

Erase All Files from a Folder

All files in a folder can be erased simultaneously.

The locked files and the files set to read-only on the PC will not be erased.

4

Erasing

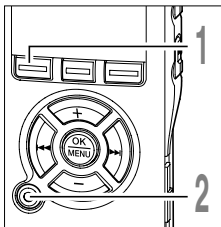

1 Press the **FOLDER** button to select the folder in which you want to erase all files.

2 Press the **ERASE** button twice. The “Cancel” indicator flashes.

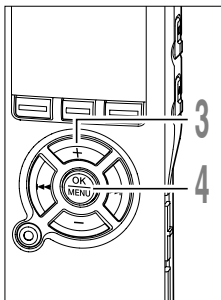
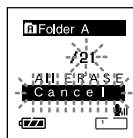

3 Press the **+** button to choose “All Erase”.

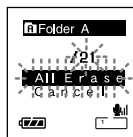

4 Press the **OK** button. The display changes to “All Erase!” and erasing will start.

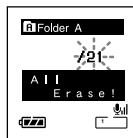

“Erase Done” is displayed when the files are erased. The locked files and read-only files are reassigned the file numbers in ascending order, starting from “1”.

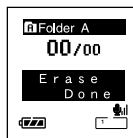

Notes

- An erased file cannot be restored.
- The locked files and the files that are set to read-only will not be erased.
- If an action is not selected within eight seconds on the “Cancel”, “Erase”, or “All Erase” screens, the recorder will return to stop status.
- It may take over 10 seconds to complete erasing. Never turn the power off or remove batteries during this time because data may be corrupted.

Index Marks and Temp Marks

If index marks and temp marks are placed, you can quickly find a location you want to listen to in fast forward and fast rewind (P36) and when cuing a file (P37). Index marks cannot be placed on files created on machines other than Olympus IC recorders, but temp marks can be placed instead to temporarily remember desired locations.

Setting an Index Mark or a Temp Mark

4

Index Marks and Temp Marks

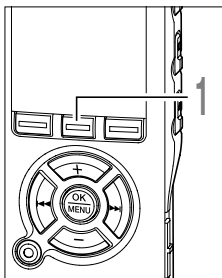

- 1 Press the **INDEX** button during recording or playing to set an index mark or temp mark.

A number appears on the display and an index mark or temp mark will be placed. Even after an index or temp mark is placed, recording or playback will continue so you can place index or temp marks in other locations in a similar manner.

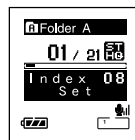

Clearing an Index Mark or a Temp Mark

Follow the procedures below to erase index or temp marks.

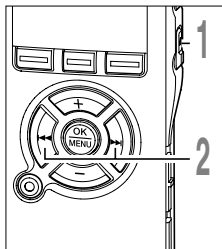

1 Locate the index or temp mark you want to clear.

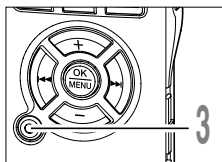
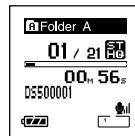

2 Press the ►► or ◀◀ button to select an index or temp mark to erase.

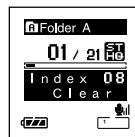

3 Press the **ERASE** button while the index or temp number appears for approximately 2 seconds on the display.

The index or temp mark is erased.

Index or temp numbers after the erased index or temp number will automatically move up.

Temp marks are temporary markings, so if you move to another file, switch to the list screen, or connect the recorder to a computer, they will be automatically erased.

Notes

- Up to 16 index and temp marks can be set in a file. If you try to place more than 16 index or temp marks, the "Index Full" message will appear for index marks, and "Temp Full" for temp marks.
- Index or temp marks cannot be set or erased in a locked file.

Formatting the Recorder (Format)

If you format the recorder, all files will be removed and all function settings will return to defaults except date and time settings. Transfer any important files to a computer before formatting the recorder.

If the recorder is formatted, data for guidance (P57), alarm playback, and starting/closing tune when the power is turned On/Off (P15) will also be erased and these features will not be available in the future. If you erase data by mistake, connect the recorder to a computer and use DSS Player to copy it to the recorder (P76).

4

Formatting the Recorder

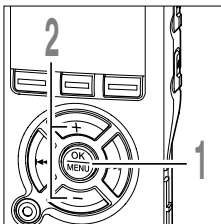

- 1 While the recorder is stopped, press the **MENU** button for 1 second or longer.

The menu opens. (P60, 62)

- 2 Press the **+** or **-** button to choose “Format”.

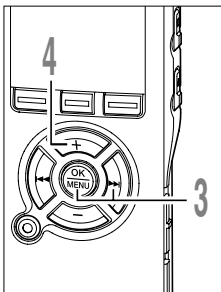
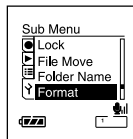

- 3 Press the **OK** or **▶▶** button.

The “Cancel” indicator flashes.

- 4 Press the **+** button to choose “Start”.

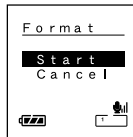
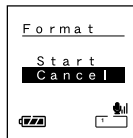

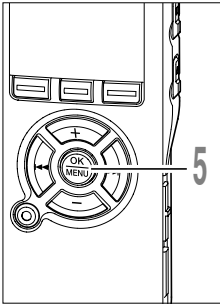

- 5 Press the OK button.**
After the “Data Will Be Cleared” message is on for two seconds, “Cancel” will turn on.

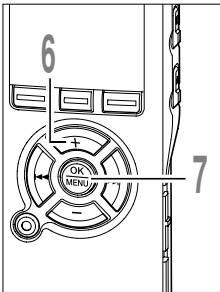
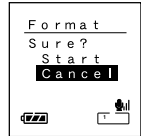
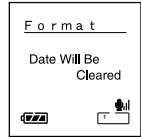

- 6 Press the + button again to choose “Start”.**



- 7 Press the OK button.**
Formatting begins and an indicator flashes on the display.

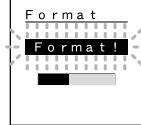

“Format Done” displays when formatting ends.

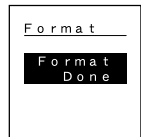

Notes

- Never turn the power off or remove batteries during formatting because data may be corrupted. It may take over 10 seconds to complete erasing.
- Never format the recorder from a PC.
- After formatting, recorded audio file names may start from 0001.
- Once the recorder is formatted, the music files with DRM may not be transferred to the recorder again.
- When the recorder is formatted, all the saved data, including locked files and read-only files, are erased.

LCD Display Information

The LCD screen on the recorder can display 3 different format of information by pressing the DISPLAY button. This help review and confirm different recorder settings and file information.

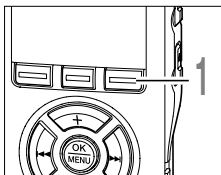

- 1 Press the DISPLAY button.**
The LCD display views will switch every time the DISPLAY button is pressed in the File Display screen.

While in stop or playback mode

When pressing Display, the recorder will cycle through ① to ③.

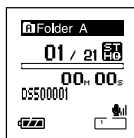

- ① Playback elapsed time / File name***
The elapsed time for the file being played and its file name (artist name/song title for a music file) will appear.

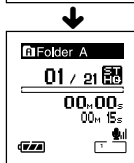

- ② Playback elapsed time / File length**
The elapsed time for the file being played and its file length will appear.

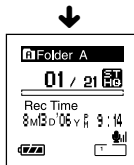

- ③ Time stamp**
Shows the month, date, year, hour and minute that the file was recorded.

*If there is a long file name, scroll to the side to show all of it.

While in record mode

Displays ① and ② alternately.

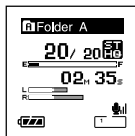

Display in the stereo recording mode

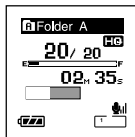

Display in the monoaural recording

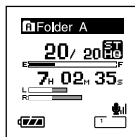

Display in the stereo recording mode

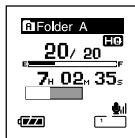

Display in the monoaural recording

① Remaining memory bars/recording time/ Recording level meter

Current elapsed recording time is displayed in incremental figures, whereas the remaining memory and audio input levels are displayed with graphic images.

The audio input level display varies depending on a stereo recording or the monoaural recording.

② Remaining memory bars/Remaining recording time/ Recording level meter

The remaining time is displayed in decremental figures, whereas the remaining memory bar and audio input levels are displayed with graphic images.

While recording in VCVA mode

Displays ① and ② alternately.

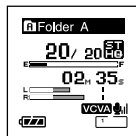

Display in the stereo recording mode

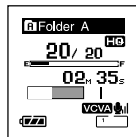

Display in the monoaural recording

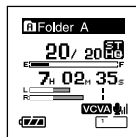

Display in the stereo recording mode

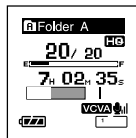

Display in the monoaural recording

① Remaining memory bars/recording time/ VCVA recording level meter

The current elapsed recording time is displayed in incremental figures, whereas the remaining memory bar, audio input levels, and start levels are displayed with graphic images ("Waiting" is displayed when the VCVA trigger level has not been reached).

The audio input level display varies, depending on a stereo recording or a monoaural recording.

② Remaining memory bars/ Remaining recording time/VCVA recording level meter

The remaining time is displayed in decremental figures, whereas the remaining memory bar, audio input levels, and start levels are displayed with graphic images ("Waiting" is displayed when the VCVA trigger level has not been reached).

Guidance (Voice Guide)

This feature gives audio announcements of recorder operating conditions. Adjust the speed and the volume of guidance announcements.

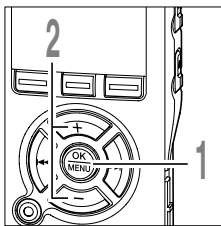

- 1** While the recorder is stopped, press the **MENU** button for 1 second or longer.

The menu opens. (P.60, 62)

- 2** Press the **+** or **-** button to choose “Voice Guide”.

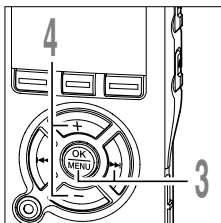
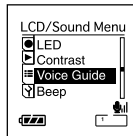

- 3** Press the **OK** or **▶▶** button.

The voice guide setup process begins.

- 4** Press the **+** or **-** button to select the item to set.

Select items you want to set from among “On/Off”, “Speed” and “Volume”.

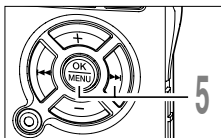

- 5** Press the **OK** or **▶▶** button to move to the respective setting.

For procedures for each setting, please see P58.

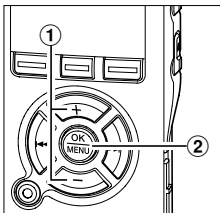

“On/Off” setting

- 1 Press the + or – button to choose between “On” and “Off”.
On: Guidance will be provided.
Off: Guidance will be canceled.
- 2 Press the OK button to exit “On/Off” selection.

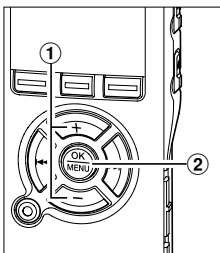
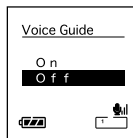

“Speed” setting

- 1 Press the + or – button to choose from “Fast”, “Normal”, and “Slow”.
Fast: Announcements at 1.5 times as fast.
Normal: Announcements at normal speed.
Slow: Announcements at 0.75 times as fast.
- 2 Press the OK button to exit “Speed” selection.

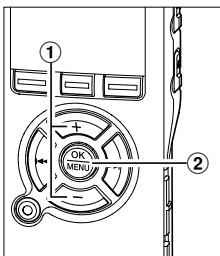
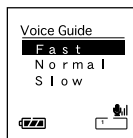

“Volume” setting

- 1 Press the + or – button to choose from “Volume High”, “Volume Middle”, and “Volume Low”.
Volume High: Increases guidance volume.
Volume Middle: Normal guidance volume.
Volume Low: Reduces guidance volume.
- 3 Press the OK button to exit “Volume” selection.

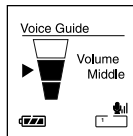

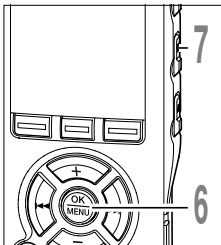

- 6 Press the OK button to complete the setup screen.**
If the **◀◀** button is pressed, the setting will be canceled and it will return to the menu.
- 7 Press the STOP button to close the menu.**

Notes

- The starting tune/closing tune when the power is turned On/Off (☞P15) can be canceled if you set the guidance to Off.
- If the recorder is formatted (☞P52), guidance data will also be erased and the feature will not be available in the future (☞P76).
- Set the starting tune/closing tune at the guidance "Volume" setting.

Menu Setting Method

Items in menus are categorized by tabs, so select a tab first and move to a desired item to quickly set it. You can set each menu item as follows.

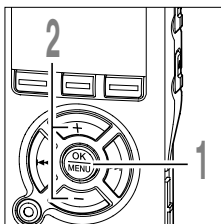

- 1 While the recorder is stopped, press the MENU button for 1 second or longer.**

The menu opens. (P62)

Menu items can be set during a recording or playback. (P64)

- 2 Press the + or - button to move to the item to be set.**

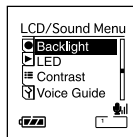
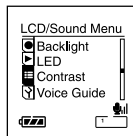
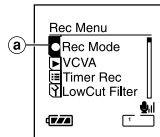
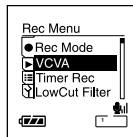
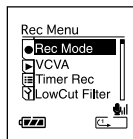

Setup using a tab

- ① Press the ◀◀ button for each item to move to a tab.
 - a Selected tab
- ② Press the + or - button to move to the tab that contains the item you want to set.
- ③ Press the OK or ▶▶▶ button to move to the item you want to set.

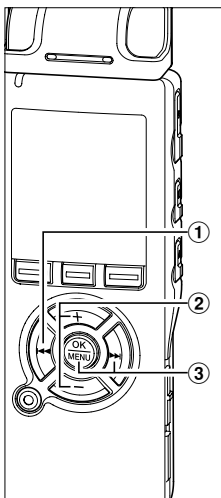

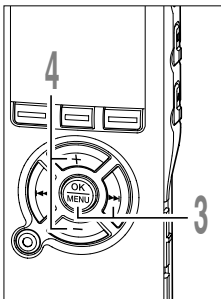

- 3 Press the OK or ►► button.**
 Moves to the setting of the selected item.

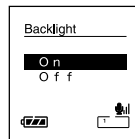

- 4 Press the + or - button to change the setting.**

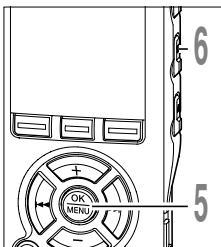
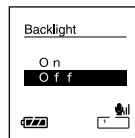

- 5 Press the OK button to complete the setup screen.**

If the ◀◀ button is pressed, the setting will be canceled and it will return to the menu.



- 6 Press the STOP button to close the menu.**

Menu List

● Menu Setting (While the recorder is stopped, press and the hold the MENU button for 1 second or longer)

Tab	Function	Setting	Ref. Page
Rec Menu ●	Rec Mode	ST XQ, ST HQ, HQ, SP, LP	P 30
	VCVA	On, Off	P 28
	Timer Rec	You can program timer recording On/Off, Day, Time, Rec Mode, Folder and Mic Sense in Preset 1 through 3.	*
	LowCut Filter	On, Off	P 32
Play Menu ▶	Play Speed	Programs S. Play and F. Play speeds.	*
	Noise Cancel	High, Low, Off	P 43
	Voice Filter	On, Off	P 45
	Play Mode	File, File Repeat, Folder, Folder Repeat All Files, All Files Repeat	P 39
	Skip Space	Programs skip space for F. Skip and R. Skip.	*
	Alarm	You can program Alarm Playback On/Off, Day, Start Time, Volume, Alarm and Playback File in Preset 1 through 3.	*
LCD/Sound Menu (To the next page)	Back Light (To the next page)		

*Please see online manual for details.

Tab	Function	Setting	Ref. Page
LCD/Sound Menu 	Backlight	On, Off	*
	LED	On, Off	*
	Contrast	Programs contrast level (01-12).	*
	Voice Guide	On/Off, Speed, Volume	P 57
	Beep	On, Off	*
Sub Menu 	Lock	On, Off	*
	File Move	Programs the order in which to play files in the folder.	*
	Folder Name	Sets a folder name from the preset template.	*
	Format	Start, Cancel	P 52
	USB Class (To the next page)		

*Please see online manual for details.

Tab	Function	Setting	Ref. Page
Sub Menu Y	USB Class	Storage Class, Audio Class	*
	Time & Date	In order of hour, minute, year, month, and day	P 17
	Power Save	In order of 5min., 10min., 30min., 1 hour, and Off	*
	Ext. Input	Auto, Stereo	*
	System Info.	Capacity/Model Name, Version/Serial	*
Rec Menu (P 62)	Rec Mode (To the page 62)		

*Please see online manual for details.

● Setting menu during recording

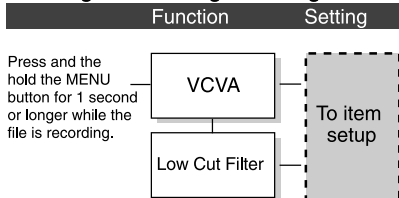

● Setting menu during playback

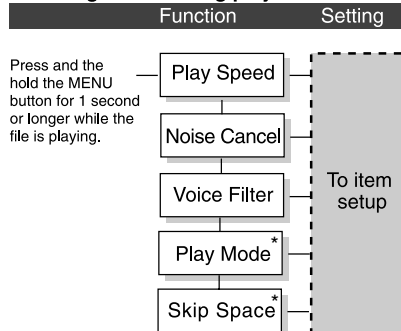

*“Play Mode” and “Skip Space” cannot be set in the Audible mode.

Saving Files in Your PC

By being connected to a PC, the recorder enables you to do the following:

- Playback voice files on your PC.
Audio files recorded using the recorder can be played using the DSS Player software included on the provided CD-ROM or Windows Media Player.
- Playback voice files on your PC and on the recorder when connected via USB. Download files from the recorder to the PC or upload files from the PC to the recorder.
- Using the Windows Media Player, the stored WMA or MP3 files on your PC can be transferred and played back on this recorder.
- If an upgrade (Option) to DSS Player Plus is executed, various additional functions can be utilized (☞ P77).

Precautions on using the recorder connected to a PC

- When you are downloading a file from the recorder or uploading a file to the recorder, do not remove the USB cable even if the screen is indicating you can. Data is still being transferred while the record/play indicator light is blinking. When removing the USB cable, be sure to follow the description in ☞ P74. If the USB cable is removed before the drive is stopped, data may not be successfully transferred.
- On a PC, do not format the drive of the recorder. Initialization is not successfully achieved on a PC. For initialization, follow the instructions in the main menu screen of the recorder (☞ P60, 62).
- Folder (directory) names displayed by file management tools such as Explorer attached to Microsoft Windows is different from the folder names that can be set with the recorder or DSS player.
- If folders or files stored on the recorder are moved or renamed by using a file management tool such as Explorer, the order of files may be changed or files may become unrecognizable.

Saving Files in Your PC

- Data can be written or uploaded to the recorder even though the attribute of the recorder drive is shown as Read-only by the operating system of the PC.
- As the noise may cause adverse effects on electronics devices nearby the recorder, unplug the earphone when you connect the recorder to a PC.

Using DSS Player Software

Basic Operating Environment of DSS Player

PC:	IBM PC/AT compatible PC
Operating System:	Microsoft Windows 2000 Professional/XP Professional, Home Edition
CPU:	Intel Pentium II class 333 MHz processor or more (If recording to a hard disk directly with the WMA format, please use in the range of 500 MHz or more)
RAM:	128 MB or more (256MB or more is recommended)
Hard drive space:	50 MB or more
Drive:	2x or faster CD-ROM, CD-R, CD-RW, DVD-ROM drive
Sound card:	Creative Labs Sound Blaster 16 or 100% compatible sound card
Browser:	Microsoft Internet Explorer 4.01 SP2 or later
Display:	800 x 600 pixels or more, 256 colors or more
USB port:	One free port
Audio I/O terminals:	Earphone output or speakers
Others:	<ul style="list-style-type: none">• The mouse or similar to a pointing device.• Environment where the Internet can be utilized.

Notes

- The support service will not cover if your PC has been updated from Windows 95/98/Me to Windows 2000/XP.
- Any failure on a self-modified PC will not be covered under the operational warranty.

Installing Software

Before you connect the recorder to your PC and use it, you must first install the DSS player software from the included Software CD.

Applications included with “DSS Player”

- DSS Player: Recorded voice files can be downloaded to the PC for complete file management and playback solution.

Be sure to confirm the following before installation:

- Exit all running applications.
- Eject the floppy disk if you are using one.
- You need to log on as an Administrator.

1 Insert DSS Player into the CD-ROM drive.

The installation program will start automatically. Once the program starts, jump to step 4. If it does not, follow the procedures in steps 2 and 3.

2 Click the [start] button and select [Run].

3 Enter “D:\setup.exe” in the [Open] field and click [OK] .

This is assuming the CD-ROM drive is D.

4 The installation Language Selection dialog box opens.

Click the desired language to select it.

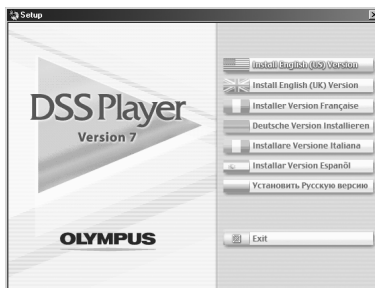

Installing DSS Player

5 Register user information.

Enter your name, company name and serial number. For the serial number, see the label attached to the CD-ROM package provided with DSS Player. When entered, click [Next]. When the confirmation dialog appears, click [Yes].

6 Confirm your acceptance of the terms of the Licensing Agreement.

You must accept the terms of the Licensing Agreement to install DSS Player. If you accept them, click [Yes].

7 Select where to install DSS Player.

This lets you specify the folder in which to install DSS Player. Click [Browse] to find the desired installation folder. To accept the default folder, click [Next].

Note

If the installation folder does not exist, a confirmation dialog box opens to get your permission to create a folder for this purpose. Click [Yes].

8 Select a program menu folder.

You may change the program menu folder to another one, such as [Start Up]. To accept the default folder, click [Next].

9 Authorizing the start of file copying.

Confirm all “Current Settings”. To accept them, click [Next].

Note

To change the program menu folder or installation folder, click [Back].

10 Copy files.

Wait until DSS Player is installed on your PC, then click [Finish]. The screen returns to the opening screen automatically.

Installing the Device Driver

11 **Connect the recorder to your PC, referring to “Connecting to Your PC” (☞ P73).**

When you connect the recorder to your PC for the first time after installing DSS Player, the recorder’s driver will be installed automatically. If the driver is installed properly, DSS Player will start automatically.

(For details about operation for DSS Player see pages from P75)

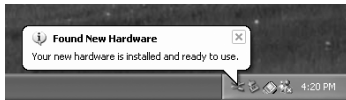

Using Online Help

To open Online Help, you have the following options.

- Click the [start] button, select [All Programs], then [Olympus DSS Player], then click [Help].
- While DSS Player is running, choose [Contents] from the [Olympus DSS Player Help] menu.
- While DSS Player is running, press [F1] on the keyboard.

Search by Contents

1 Once the Online Help screen appears, click the Contents tab.

2 Double-click the  icon of the desired topic heading.

The title of the topic is displayed.

3 Double-click the  icon of the desired topic.

An explanation of the topic is displayed.



Search by Key word

1 Once the Online Help screen appears, click the Index tab.

2 Enter text.

Matching keywords are located automatically.

3 Choose a topic, then click [Display].

An explanation of the topic is displayed.

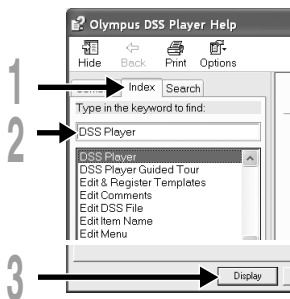

Note

- For more information on menus and operations, refer to Online Help. You will be able to use Online Help after DSS Player is installed.

Connecting to Your PC

Be sure to finish installing DSS Player before connecting the recorder (P69).

Connecting to your PC using the USB cable

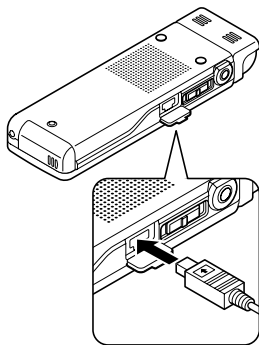
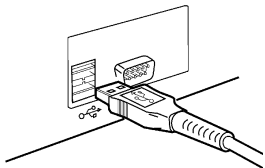

- 1 Turn the recorder's power ON.
- 2 Connect the USB connection cable to the USB port or the USB hub of the PC.
- 3 Confirm that the recorder has stopped and connect a USB cable to the connection port on the side of recorder.

“Remote (Storage)” is displayed on recorder if the USB cable is connected.

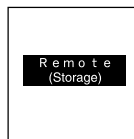

When the recorder is connected and “My Computer” is opened, a removable disk drive is displayed.

Notes

- When connecting this recorder with the PC and utilize DSS Player, in the menu setting of this recorder set the USB class to the “Storage Class”. If connected by “Audio Class”, this recorder will not be recognized as a removable disk drive.
- Be sure to use the attached dedicated cable for the USB connecting cable. If any other company's cable is used, it will be the cause trouble. Also, please do not connect this dedicated cable to any other company's product.

Disconnecting from Your PC

- 1 Click the  on the task bar located at the lower-right corner of the screen. Click [Safely Remove Hardware].

The drive letter will differ depending on the PC being used.

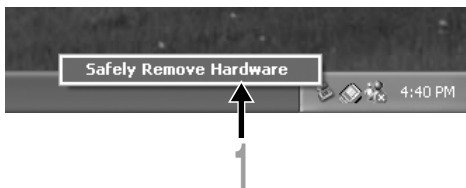

- 2 Disconnect the USB cable.

Notes

- NEVER disconnect the USB while the record/play indicator light is flashing. If you do, the data will be destroyed.
- When the recorder is connected to a PC, the power will be supplied from the USB cable.
- Refer to the user's manual for your PC regarding the USB port or USB hub on your PC.
- Be sure that you connect the USB cable either directly to the USB port on your PC or the self-power (AC adapter connection) USB hub.
- Be sure to push the cable connector all the way in. Otherwise, the recorder may not operate properly.
- Cancel Hold mode.

Running DSS Player

By connecting the recorder to your PC, you can automatically start the application.

Disabling automatic start

- 1 Right click on the  of the taskbar on the lower right of the screen, and select [Setting].
The application which enables setting will be displayed by dialog.
- 2 Click the of the [DSS Player Version 7].
The check mark on [DSS Player Version 7] disappears. For automatic start, select and click DSS Player to reinstate again.

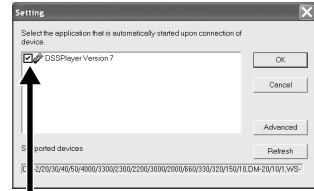

Manual start

- 1 Start Windows.
- 2 Click the [start] button, select [All Programs], then [Olympus DSS Player].
- 3 Click [Olympus DSS Player].

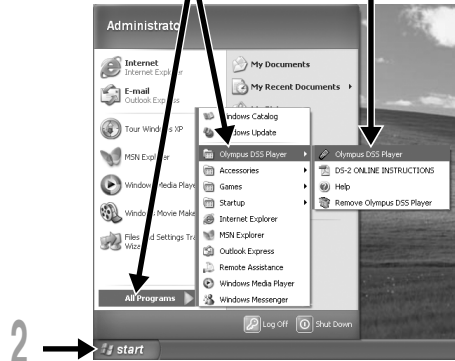

Note

- You cannot run more than one DSS Player program or multiple copies of the same program simultaneously.

Copying Voice Guide Data

If you format the recorder and erase data by mistake, you can copy the voice guide data from DSS Player to the recorder.

1 Make sure that the recorder's voice guide is set to “On”.

If the recorder's voice guide is set to “Off” the voice guide data cannot be copied.

2 Connect the recorder to a PC.

For how to connect to a computer, see “Connecting to your PC using the USB cable” (P.73).

3 Start DSS Player.

If the recorder does not have voice guide data, the [File Transfer] dialog will appear.

4 Copy voice guide data.

If you click the [Yes] button in the [File Transfer] dialog, it will start copying voice guide data, and a window indicating copying progress will appear.

5 Copying of the voice guide data will be completed.

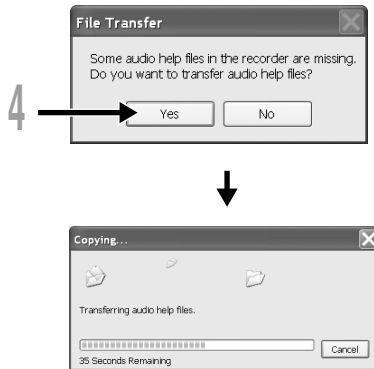

Notes

- The alarm sound, the Starting tune that plays when the recorder is starting up, and the Closing tune that plays when the recorder is turning off (P.15), will be copied together with the guidance data.
- NEVER disconnect the USB while the record/play indicator light is flashing. If you do, the data will be destroyed.

Upgrade Function

The “DSS Player” enables upgrades (Options) to the “DSS Player Plus” which is equipped with more functions. In addition to the DSS Player functions, voice recognition using voice recognition software, joining of files, sharing of files and the menu setting of this recorder can be utilized.

Purchase and Upgrade

To purchase “DSS Player Plus” and upgrading from “DSS Player” is operated in the following procedures.

- 1 **Start the DSS Player.**
Please see P75 for the starting method.

- 2 **Click the  button or select [Purchase a new license for DSS Player Plus] in the [Help] menu.**
The web browser will start and the purchase site of the DSS Player Plus will be displayed. Please operate according to guidance on the screen.
When the purchase procedure is completed, the license number will be issued by mail.

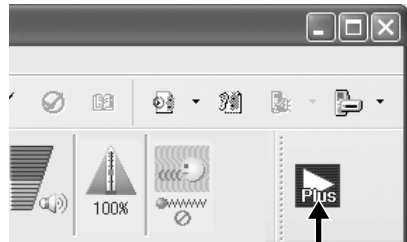

3 Select [Upgrade to DSS Player Plus] from the [Help] menu.

The “Upgrade to DSS Player Plus” dialog will be displayed.



4 In the [Upgrade to DSS Player Plus] dialog, enter the license number of your purchase, and click the [OK] button.

When starting the application next time, DSS Player will be upgraded to DSS Player Plus.



Upgrading to DSS Player Plus

When upgraded, the title of the main menu changes to [DSS Player Plus]. Also, you can confirm the upgrade by selecting [About DSS Player] from the [Help] menu on the tool bar. In the [About DSS Player] window, the [DSS Player Plus] should be displayed.

Notes

- To purchase the license number, it requires an environment where the Internet can be utilized.
- Please see the details in the website regarding the purchase of the license number.

Importing Content for Listening on the Recorder

You can transfer language content and music files imported from language CDs and the Internet using Windows Media Player for playing on the recorder.

You can also use DSS Player to import and enjoy Podcast content found on the Internet.

The recorder is compatible with WMA and MP3 language content.

In addition, recorder is compatible with the Audible content of the ACELP and MP3 formats when recorder is in the Audible mode.

Import files using Windows Media Player

- Copy music files and language content from CDs to a computer.
➔ Please see “Copying Music from CD” (📖 ONLINE INSTRUCTIONS P138) for details.
- Transfer copied music files and language content from the computer to the recorder.
➔ Please see “Transferring Music File to the Recorder”(📖 ONLINE INSTRUCTIONS P139) for details.

Import files using DSS Player

- Import Podcast content from the Internet to a computer.
➔ Please see “Importing Podcast Content”(📖 ONLINE INSTRUCTIONS P142) for details.

Download Audible content using the Audible Manager

- Download Audible content available from the Audible web site for a fee to a computer.
➔ See “Loading Audible Content” (📖 ONLINE INSTRUCTIONS P146) for details.

Directly record files to the Recorder

- Connect the recorder to another device to record directly to the recorder.
➔ Please see “Recording the Sound of Other Devices with This Recorder”(📖 ONLINE INSTRUCTIONS P35) for details.

Using as External Memory of the Computer

With the recorder connected to your PC, you can download data from the memory to your PC and upload data stored on your PC to the memory.

Example: Copying Data from PC to Recorder using Explorer

1 Start Windows.

2 Connecting the recorder to your PC.

For the connection procedure, refer to “Connecting to Your PC using the USB cable” (P73).

3 Open the Explorer window.

The product’s name is displayed.

4 Copy the data.

While the data are being written or copied, the record/play indicator light on the recorder will flash.

5 Unplug the recorder from a computer.

For how to unplug the recorder, please see “Disconnecting from your PC” (P74).

Notes

- NEVER disconnect the USB while the record/play indicator light is flashing. If you do, the data will be destroyed.
- Make sure that the computer setting is storage class. If it is audio class, it won't recognize the recorder as a removable disk (P.73).

Alarm Message List

Message	Meaning	Explanation	Action
Battery Low	Low battery power	Battery power is getting low.	Replace with new batteries (☞ P13).
File Protected	Erase-locked	Tried to delete a locked file.	Unlock the file.
Index Full	Index full	The file is full of index marks (maximum of 16 marks).	Erase index marks that are no longer required (☞ P51).
Temp Full	Tempmark full	The file is full of Tempmarks (maximum of 16 marks).	Erase Tempmarks that are no longer required (☞ P51).
Illegal Folder	Not an audio-recording folder.	Recording has been attempted with a folder other than "Folder A" through to "Folder E".	Select a folder from "Folder A" through to "Folder E" and try recording again (☞ P25).
Folder Full	Folder full	The folder is full of files (maximum of 200 files).	Erase unnecessary files (☞ P47).
Memory Error	Error in the internal memory	Error in the internal memory.	This is a malfunction, so go to the store where you purchased the recorder or an Olympus service station for repair.
Licence Mismatch	Illegally copied file	The music files copied illegally.	Delete the file (☞ P47).
Memory Full	Zero remaining memory	No remaining internal memory.	Erase unnecessary files (☞ P47).
No File	No file	No files were found in the folder.	Select another folder.
Format Error	Formatting error	There was an error while formatting the recorder's memory.	Reformat the memory (☞ P52).
Can't Make The System File.Connect To PC And Delete Unnecessary File	The management file cannot be created.	The file for management cannot be created due to a shortage of capacity for remaining flash memory.	Connect the recorder to a computer and delete any unnecessary files.

Troubleshooting

Symptom	Probable cause	Action
Nothing appears on the display	The batteries are not loaded properly.	Verify polarity is correct.
	The batteries are dead.	Replace with new batteries (☞ P13).
	The power is off.	Turn the power on (☞ P15).
Won't start	The power is off.	Turn the power on (☞ P15).
	The recorder is in HOLD mode.	Release the recorder from HOLD (☞ P16).
	The batteries are dead.	Replace with new batteries (☞ P13).
Unable to record	Low remaining internal memory.	Erase unnecessary files (☞ P47).
	The maximum number of files has been reached.	Check another folder.
No playback tone heard	The earphone is connected.	Unplug the earphones to use the internal speaker.
	The VOLUME button is set to 0.	Adjust the VOLUME button (☞ P35).
Unable to erase	The file is locked.	Unlock the file.
	The file is read-only.	Cancel the read-only setting of the file on the PC.
Noise heard during playback	The recorder was shaken during recording.	—
	The recorder was placed near a cell phone or fluorescent lamp while recording or during playback.	Move the recorder.
Recording level too low	The microphone sensitivity is too low.	Set the microphone sensitivity to LECTURE or CONF mode and try again (☞ P31).
Unable to set index marks, tempmarks	The maximum number of marks has been reached.	Erase unnecessary marks (☞ P51).
	The file is locked.	Unlock the file.
	The file is read-only.	Cancel the read-only setting of the file on the PC.

Symptom	Probable cause	Action
Cannot find the recorded voice	Wrong folder.	Switch to the right folder.
The recorder does not start at the set time with “Timer Rec” or “Alarm”	The clock has not been set properly.	Verify the “Current Time” to reset the date and time if they are not properly set (☞ P18).
The Alarm, Starting tune and Closing tune, and guidance are not available	The data has been deleted by the formatting.	Copy the data to the recorder using the DSS Player (☞ P76). When copy the guidance data, the Alarm, Starting tune and Closing tune are also copied together.

Accessories (optional)

Stereo microphone: ME53S

This is a stereo microphone dedicated to the DS-30, DS-40 and DS-50 models. Three types are available, the ME53SH which is the same color as the DS-30 model, the ME53SS which is the same color as the DS-40 model, and the ME53SA which is the same color as the DS-50 model.

Stereo microphone: ME51SW

The high fidelity of the recording, which only stereo can perform. Furthermore, it gives clear sound quality with less noise.

Highly sensitive noise-cancellation monaural microphone: ME52

This microphone is used to record sound at a distance while minimizing surrounding noise.

Noise-Cancellation monaural microphone: ME12

(Dictation microphone)

Used to get crisp recordings of your own voice by reducing the effects of ambient noise.

Tie clip microphone: ME15

(Monaural)

Small concealing microphone with a tie-clip.

Telephone pickup: TP7

Earphone type microphone can be plugged into your ear while phoning. The voice or conversation over the phone can be clearly recorded.

AC adapter: A321 (US and Canada) or A322 (Europe except U.K.)

Ni-MH rechargeable battery and charger set: BC400 (Europe only)

BC400 comes with an Ni-MH rechargeable battery charger (BU-400) and 4 Ni-MH rechargeable batteries (BR401) as a pack. This charger can quick charge Olympus AA or AAA Ni-MH rechargeable batteries.

Ni-MH rechargeable battery: BR401

High-efficiency rechargeable long life batteries.

Connecting cord: KA333

Connecting cord which has stereo mini-plugs (ø3.5) with resistance at both ends. Use to connect from the earphone jack output of the recorder to the microphone input jack when recording.

Converting plug adapters (PA331/PA231) which convert to the monaural mini plug (ø3.5) or monaural mini plug (ø2.5) are also enclosed.

Exclusive remote control: RS29 (supplied for the DS-50 only)

Special remote control for the DS-30, DS-40, and DS-50.

Remotely controls the recorder's recording/stop functions.

If the supplied stereo microphone (ME53S) is plugged in, it can be used as a remote control stereo microphone.

Exclusive case: CS113 (supplied for the DS-50 only)

Special case for the DS-30, DS-40, and DS-50. Protects the recorder from shocks and dirt.

Belt loop on the back of the case.

Magnet hook for smooth opening and closing.

Specifications

Recording format

WMA (Windows Media Audio)

Input level

-70 dBv

Sampling frequency

STEREO XQ mode: 44.1 kHz

STEREO HQ mode: 44.1 kHz

HQ mode: 44.1 kHz

SP mode: 22 kHz

LP mode: 8 kHz

Overall frequency response

STEREO XQ mode: 50 to 19,000 Hz

STEREO HQ mode: 50 to 16,000 Hz

HQ mode: 50 to 13,000 Hz

SP mode: 100 to 8,000 Hz

LP mode: 100 to 3,000 Hz

Recording time

DS-50: 1 GB

STEREO XQ mode: 17 hours 30 minutes

STEREO HQ mode: 35 hours 10 minutes

HQ mode: 70 hours 20 minutes

SP mode: 138 hours 30 minutes

LP mode: 275 hours 20 minutes

DS-40: 512 MB

STEREO XQ mode: 8 hours 40 minutes

STEREO HQ mode: 17 hours 20 minutes

HQ mode: 34 hours 45 minutes

SP mode: 68 hours 30 minutes

LP mode: 136 hours 15 minutes

DS-30: 256 MB

STEREO XQ mode: 4 hours 10 minutes

STEREO HQ mode: 8 hours 30 minutes

HQ mode: 17 hours 00 minutes

SP mode: 33 hours 30 minutes

LP mode: 66 hours 40 minutes

Alkaline battery life

Recording:

STEREO XQ mode: Approx. 20 hours

STEREO HQ mode: Approx. 22 hours

HQ mode: Approx. 24 hours

SP mode: Approx. 28 hours

LP mode: Approx. 32 hours

Playback: (All mode)

Speaker playback: Approx. 12 hours

Earphone playback: Approx. 26 hours

Ni-MH Rechargeable Battery (BR-401) life

Recording:

STEREO XQ mode: Approx. 15 hours

STEREO HQ mode: Approx. 16 hours

HQ mode: Approx. 18 hours

SP mode: Approx. 21 hours

LP mode: Approx. 22 hours

Playback: (All mode)

Speaker playback: Approx. 9 hours

Earphone playback: Approx. 20 hours

Recording medium

Built-in flash memory

DS-50: 1 GB

DS-40: 512 MB

DS-30: 256 MB

Speaker

Built-in \varnothing 23 mm round dynamic speaker

MIC jack

\varnothing 3.5 mm mini-jack, impedance 680 Ω

EAR jack

\varnothing 3.5 mm mini-jack, impedance 8 Ω or more

Maximum working output (3 V DC)

250 mW or more (8 Ω speaker)

Maximum headphone output

5 mW + 5 mW (at load of 22 Ω)

Clock accuracy

Monthly deviance less than 120 seconds.

Input power requirement

Rated voltage: 3 V

Batteries: Two AAA batteries
(LR03,R03 or ZR03) or Two
Ni-MH rechargeable
batteries

External power supply: AC adapter

External dimensions

Recorder:96 x 37.5 x 16 mm
(without protrusions)

Microphone(ME53S)+Recorder:
111 x 37.5 x 16 mm (without protrusions)

Weight

Recorder:73 g
(including alkaline batteries)
Microphone(ME53S)+Recorder:80g
(including alkaline batteries)

* Specifications and design are subject to change without notice.

* Battery life is measured by Olympus. It varies greatly according to the type of batteries used and the conditions of use.

Technical Assistance and Support

The following are contact information for technical support for Olympus recorders and software only.

◆ Technical Hotline Number in the U.S. and Canada
1-888-553-4448

◆ User Support E-mail address in the U.S. and Canada
distec@olympus.com

◆ Technical Hotline Number in Europe
Toll free number
00800 67 10 83 00

available for Austria, Belgium, Denmark, Finland, France, Germany, Italy, Luxemburg,
Netherlands, Norway, Portugal, Spain, Sweden, Switzerland, United Kingdom

Charged numbers for the Rest of Europe
+49 180 567 1083
+49 40 23773 899

◆ User Support E-mail address in Europe
dss.support@olympus-europa.com

OLYMPUS®

OLYMPUS IMAGING CORP.

Shinjuku Monolith, 3-1 Nishi-Shinjuku 2-chome, Shinjuku-ku, Tokyo 163-0914, Japan. Tel. 03-3340-2111

OLYMPUS IMAGING AMERICA INC.

3500 Corporate Parkway, P.O.Box 610, Center Valley, PA 18034-0610, U.S.A. Tel. 1-888-553-4448

OLYMPUS IMAGING EUROPA GMBH

(Premises/Goods delivery) Wendenstrasse 14-18, 20097 Hamburg, Germany. Tel. 040-237730
(Letters) Postfach 10 49 08. 20034 Hamburg, Germany.

OLYMPUS UK LTD.

2-8 Honduras Street, London EC1Y 0TX, United Kingdom, Tel.020-7253-2772
<http://www.olympus.com/>