

AC/DC Converter
Isolated PWM type, 12 W (12 V/1.0 A)
BM2P134E-Z Evaluation Board

<High Voltage Safety Precautions>

◇ Read all safety precautions before use

Please note that this document covers only the **BM2P134E-Z** evaluation board (BM2P134E-EVK-001) and its functions. For additional information, please refer to the datasheet.

To ensure safe operation, please carefully read all precautions before handling the evaluation board



Depending on the configuration of the board and voltages used,

Potentially lethal voltages may be generated.

Therefore, please make sure to read and observe all safety precautions described in the red box below.

Before Use

- [1] Verify that the parts/components are not damaged or missing (i.e. due to the drops).
- [2] Check that there are no conductive foreign objects on the board.
- [3] Be careful when performing soldering on the module and/or evaluation board to ensure that solder splash does not occur.
- [4] Check that there is no condensation or water droplets on the circuit board.

During Use

- [5] Be careful to not allow conductive objects to come into contact with the board.
- [6] **Brief accidental contact or even bringing your hand close to the board may result in discharge and lead to severe injury or death.**

Therefore, DO NOT touch the board with your bare hands or bring them too close to the board.

In addition, as mentioned above please exercise extreme caution when using conductive tools such as tweezers and screwdrivers.

- [7] If used under conditions beyond its rated voltage, it may cause defects such as short-circuit or, depending on the circumstances, explosion or other permanent damages.
- [8] Be sure to wear insulated gloves when handling is required during operation.

After Use

- [9] The ROHM Evaluation Board contains the circuits which store the high voltage. Since it stores the charges even after the connected power circuits are cut, please discharge the electricity after using it, and please deal with it after confirming such electric discharge.
- [10] Protect against electric shocks by wearing insulated gloves when handling.

This evaluation board is intended for use only in research and development facilities and should be handled **only by qualified personnel familiar with all safety and operating procedures.**

We recommend carrying out operation in a safe environment that includes the use of high voltage signage at all entrances, safety interlocks, and protective glasses.

AC-DC Convertor

PWM type Isolated ACDC Converter

Output 12 W 12 V/1.0 A

BM2P134E Reference Board

BM2P134E-EVK-001

Futures

- (1) Built-in 650 V SJ-FET and Start up circuit
- (2) Frequency 130 kHz
- (3) Corresponded W/W input voltage 90 Vac to 264 Vac
- (4) Adjustable under voltage lock out by BR terminal
- (5) Adjustable AC over voltage protection by ZT terminal



Figure 1. Evaluation Board

Electrical Characteristics

Table 1. Input Range

Description	Min	Typ	Max	Units	Conditions
Input Voltage Range	90	230	264	Vac	
Input Frequency Range	47	50/60	63	Hz	
Operating Temperature	-10	25	65	°C	

Table 2. Evaluation board specification

These are representative values and not a guarantee of the characteristics, unless stated otherwise use $V_{IN} = 230$ Vac, $I_{OUT} = 1.0$ A, $T_a = 25$ °C.

Description	Min	Typ	Max	Units	Conditions
Output Voltage	11.4	12	12.6	V	
Output Maximum Power	-	-	12	W	
Output Current Range ^(Note 1)	-	-	1.0	A	
No Load Power Consumption	-	150	-	mW	$V_{IN} = 264$ Vac
Efficiency	-	84.5	-	%	
Output Ripple Voltage ^(Note 2)	-	-	300	mV	

(Note 1) Adjust the operating time so that surface temperature of no component exceeds 105 °C

(Note 2) Do not consider spike noise

Operation Procedure

Operation equipment

- (1) AC power supply 90 Vac to 264 Vac, over 20 W
- (2) Electronic Load capacity 1.0 A
- (3) Multimeter
- (4) Power Meter

Connection method

Turn off each power supply and connect the measuring instrument as shown below.

Turn on the power of the measuring instrument and set the input voltage.

When removing the measuring instrument, reduce the input voltage before turning off the power for measurement.

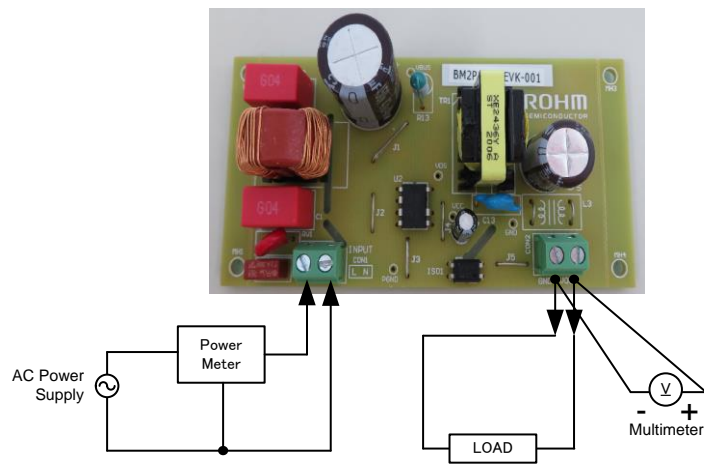

Figure 2. Connection Circuit

Schematics

VIN = 90 Vac to 264 Vac, VOUT = 12 V, IOU = 1.0 A

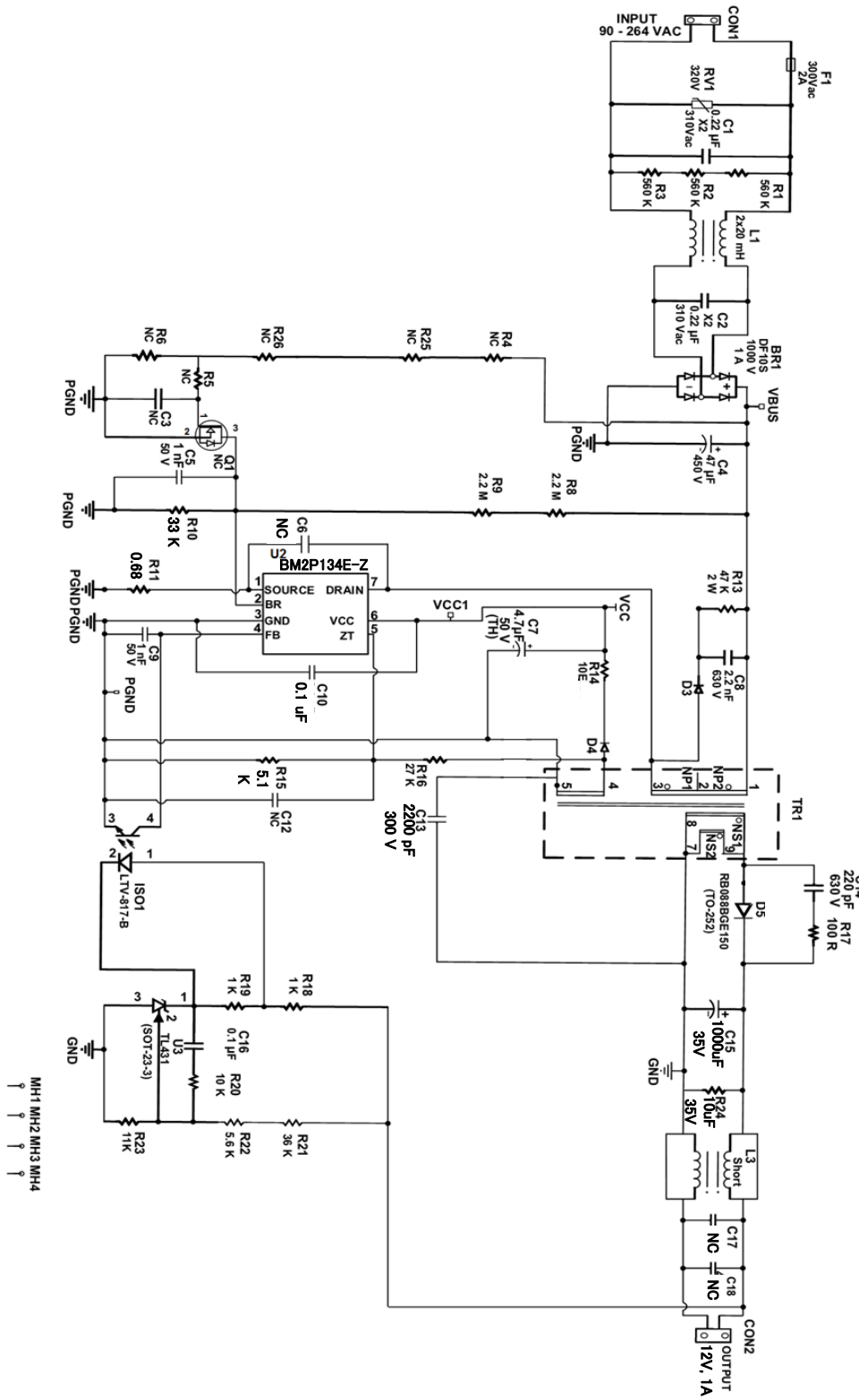

Figure 3. BM2P134E-EVK-001 Circuit

Bill of Materials

Table 3. Bill of Materials

Item		Specifications	Parts name	Manufacture
Diode Bridge	BR1	1 A, 1000 V	DF10S	DIODES Inc
Capacitor	C1,C2	0.22 μ F, 310 Vac	890334023028	WURTH ELECTRONIK
	C3		NON MOUNTED	
	C4	47 μ F, 450 V	UCY2W470MHD6TN	NICHICON
	C5,C9	1000 pF, 100 V	HMK107B7102KA-T	TAIYO YUDEN
	C6		NON MOUNTED	
	C7	4.7 μ F, 50 V	UVZ1H4R7MDD1TD	NICHICON
	C8	2200 pF, 630 V	GRM31A7U2J222JW31	MURATA
	C10,C16	0.1 μ F, 100 V	HMK107B7104KA-T	TAIYO YUDEN
	C12		NON MOUNTED	
	C13	2200 pF, 300 V	DE1E3RA222MJ4BP01F	MURATA
	C14	220 pF, 630 V	GRM31A5C2J221JW01D	MURATA
	C15	1000 μ F, 35 V	UPA1V102MPD	NICHICON
	C17		NON MOUNTED	
	C18		NON MOUNTED	
	R24	10 μ F, 35 V	GMK316AB7106ML-TR	TAIYO YUDEN
	Connector	CON1,CON2		691213710002
Diode	D3	FRD, 0.8 A, 700 V	RFN1LAM7S	ROHM
	D4	FRD, 0.5 A, 200 V	RF05VAM2STR	ROHM
	D5	SBD, 10 A, 150 V	RB088BGE150	ROHM
Fuse	F1	2 A, 300 V	36912000000	LITTELFUSE
PhotoCoupler	ISO1		LTV-817-B	LITEON
Inductor	L1	20 mH	744823220	WURTH ELECTRONIK
	L3	-	SHORT	-
-	Q1		NON MOUNTED	
Resistor	R1,R2,R3	560 k Ω	ESR18EZPJ564	ROHM
	R4		NON MOUNTED	
	R5		NON MOUNTED	
	R6		NON MOUNTED	
	R8,R9	2.2 M Ω	ESR18EZPJ225	ROHM
	R10	33 k Ω	MCR03EZPJ333	ROHM
	R11	0.68 Ω	MCR100JZHFLR680	ROHM
	R13	47 k Ω	ERG2SJ473E	PANASONIC
	R14	10 Ω	MCR18EZPJ100	ROHM
	R15	5.1 k Ω	MCR03EZPJ512	ROHM
	R16	27 k Ω	ESR03EZPJ273	ROHM
	R17	100 Ω	ESR18EZPJ101	ROHM
	R18,R19	1 k Ω	MCR03EZPJ102	ROHM
	R20	10 k Ω	MCR03EZPJ103	ROHM
	R21	36 k Ω	MCR03EZPF3602	ROHM
	R22	5.6 k Ω	MCR03EZPF5601	ROHM
	R23	11 k Ω	MCR03EZPF1102	ROHM
	R25		NON MOUNTED	
	R26		NON MOUNTED	
	RV1	320 V, 1.2 KA, \varnothing 7 mm	V07E320P	LITTELFUSE
Transformer	TR1	EE20/10/6	XE2436 A	ALPHA TRANS
IC	U2		BM2P134E-Z	ROHM
	U3		TL431BIDBZT	TI

Design Reference of Transformer

Manufacturer: ALPHA TRANS

Bobbin: PY-2020-1

Core: EE20/10/6

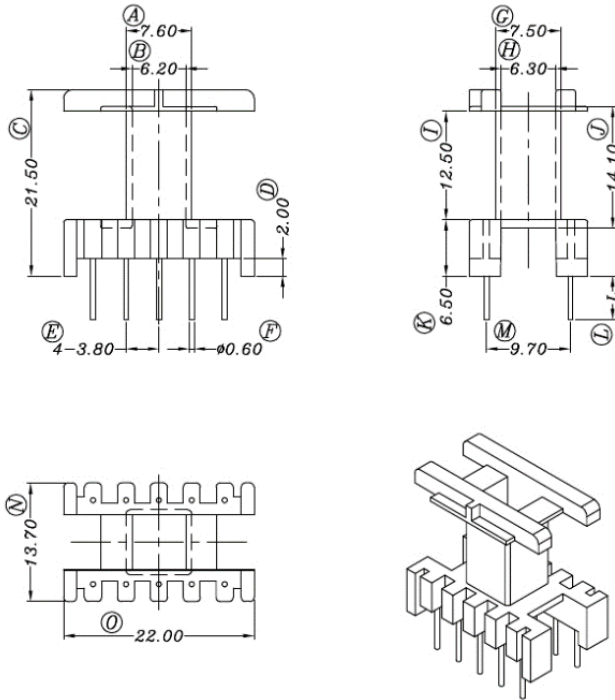

Figure 4. Bobbin diagram

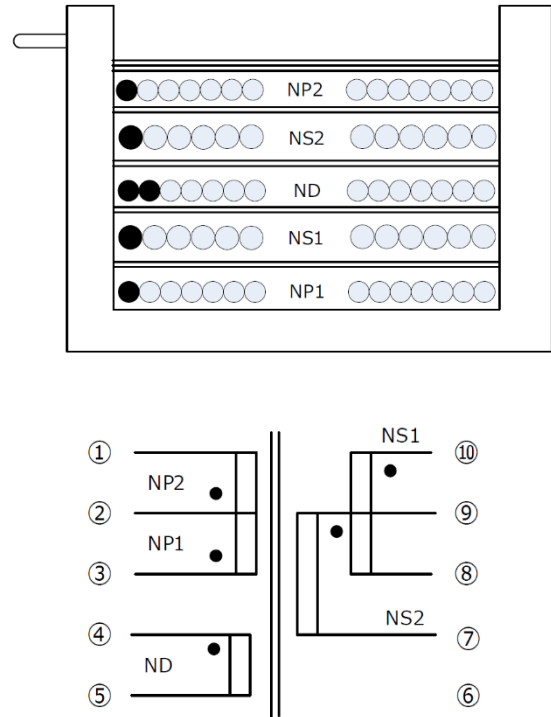

Figure 5. Winding structure diagram

Table 4. Würth Transformer Winding Specification

Coil	Terminal	Turns	Wire	Winding Method
NP1	3-2	32	1 X2UEW 0.25 mm	1 Layer Fit
NS1	10-8	10	1 X1TIW 0.55 mm	1 Layer Space
ND	4-5	13	2 X2UEW 0.2 mm	1 Layer Space
NS2	9-7	10	1 X TIW 0.55 mm	1 Layer Space
NP2	2-1	31	1 X2UEW 0.25 mm	1 Layer Fit

Inductance (L_p): 397 μH ± 10 % (100 kHz)

Leakage Inductance: 20 μH Max

Withstand Voltage: Pri – Sec 3 kV 1 min. 1 mA

Pri – Core 1.5 kV 1 min. 1 mA

Sec - Core 1.5 kV 1 min. 1 mA

PCB

Size: 104 mm x 50 mm

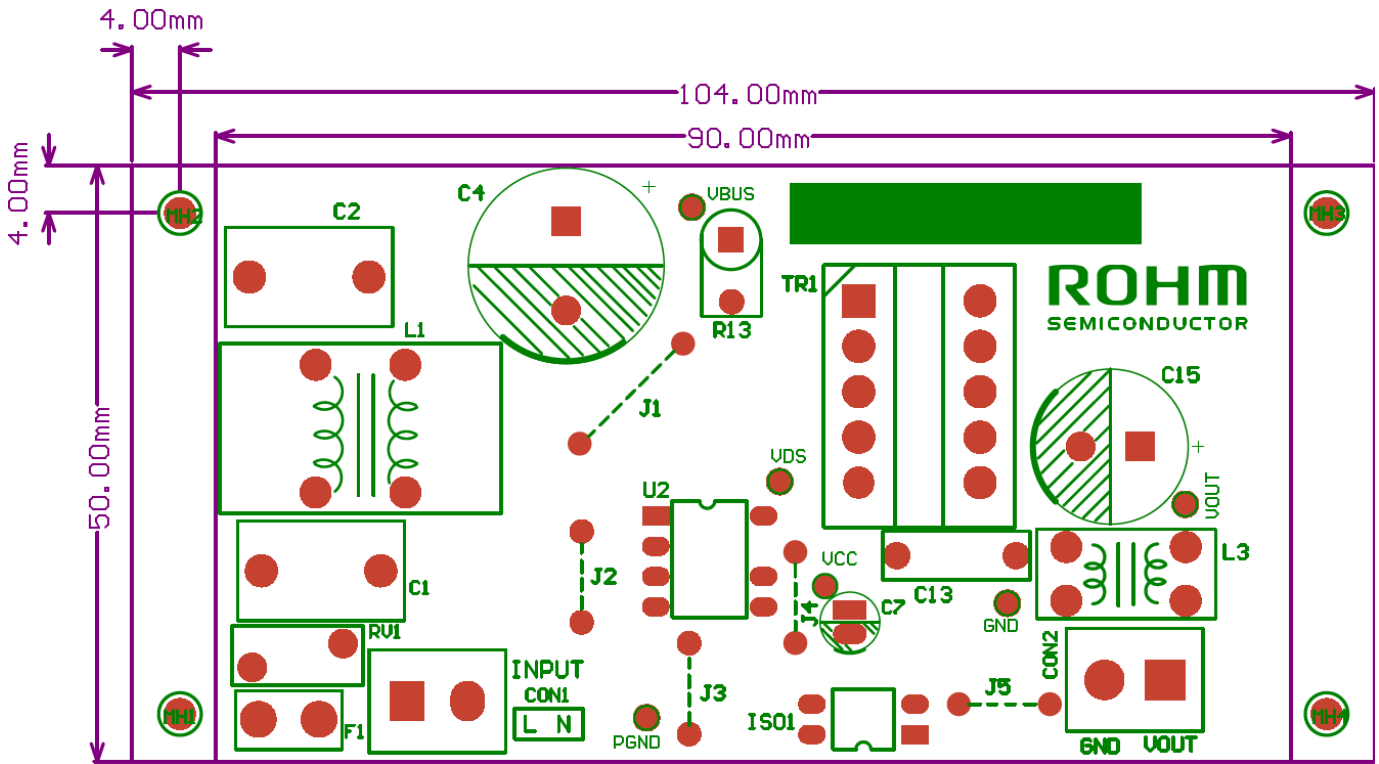

Figure 6. Top Silkscreen (Top view)

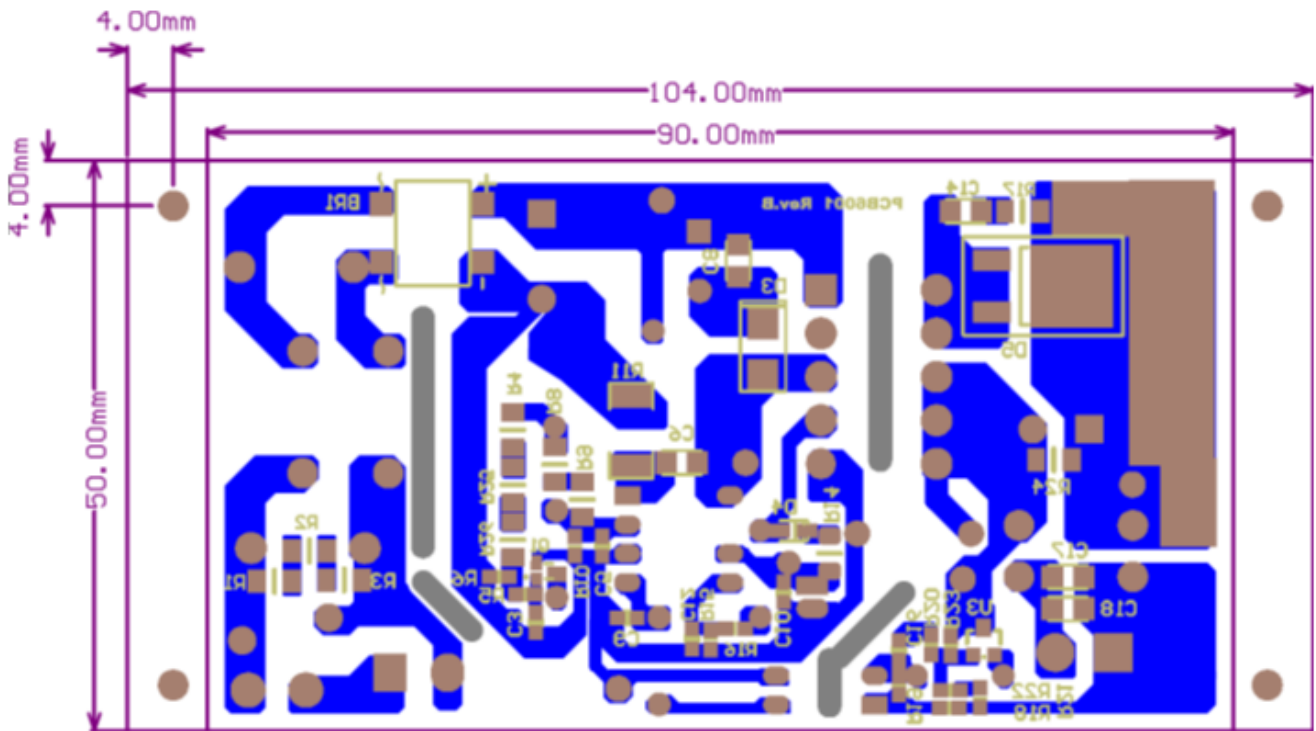

Figure 7. Bottom Layout (Top view)

BM2P134E Overview

Features

- PWM frequency of 130 kHz
- PWM Current mode method
- Built-in Frequency Hopping Function
- Burst Operation at Light Load
- Frequency Reduction Function
- Built-in 650 V Starter Circuit
- Built-in 650 V Super Junction MOSFET
- VCC Pin Under Voltage Protection
- VCC Pin Over Voltage Protection
- Over Current Limiter Function per Cycle
- Over Current Limiter with AC Voltage Correction
- Soft Start Function
- Brown IN/OUT Function
- ZT Pin OVP Function

Key Specifications

- Operating Power Supply Voltage Range:
 - VCC: 8.90 V to 26.00 V
 - DRAIN: 650 V(Max)
- Operating Current(Normal): 1.00 mA(Typ)
- Operating Current(Burst): 0.30 mA(Typ)
- Switching Frequency: 130 kHz(Typ)
- MOSFET ON Resistance: -40 °C to +105 °C
- MOSFET ON Resistance: 3.0 Ω(Typ)

package :

DIP7AK **W(Typ) x D(Typ) x H(Max)**
 9.27 mm x 6.35 mm x 8.63 mm
 Pitch 2.54 mm

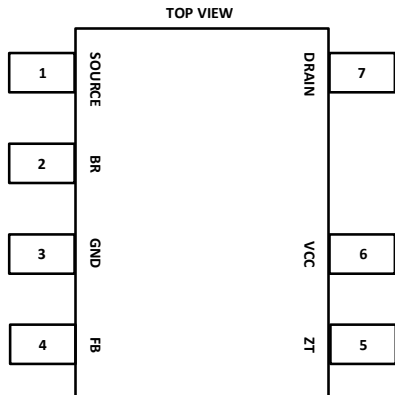

Figure 8. IC Pin Diagram

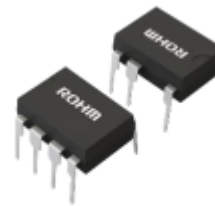

Figure 9. Package Image

Table 5. BM2P134E pin description

No	Pin Name	I/O	Function
1	SOURCE	I/O	MOSFET SOURCE pin
2	BR	I	AC voltage detect pin
3	GND	I/O	GND pin
4	FB	I	Feedback signal input pin
5	ZT	I	Auxiliary winding Input pin
6	VCC	I	Power supply Input pin
7	DRAIN	I/O	MOSFET DRAIN pin

Measurement DATA

Constant Load Regulations

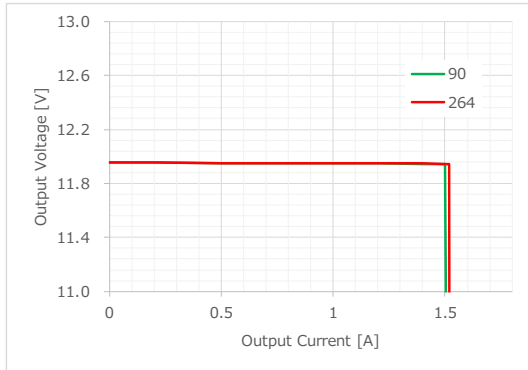

Figure 10. Load Regulation (IOUT vs. VOUT)

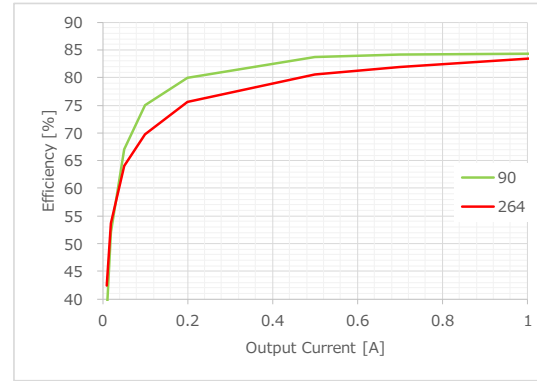

Figure 11. Load Regulation (IOUT vs. Efficiency)

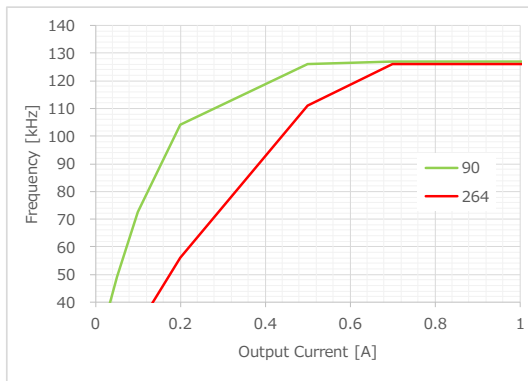

Figure 12. Load Regulation (IOUT vs. F_{sw})

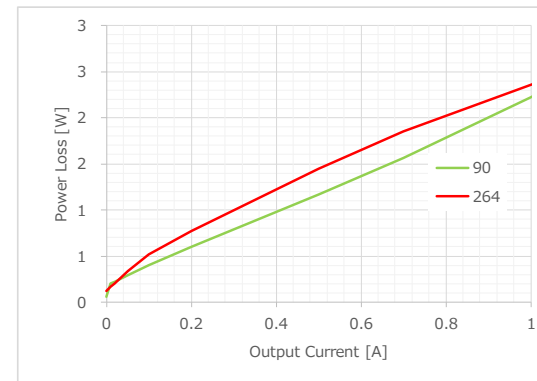

Figure 13. Load Regulation (IOUT vs. P_{Loss})

Measurement DATA -

Operation Waveform (Primary side)

Time 5 ms/10 μ s
 CH1 50 V/div
 CH2 500 mA/div

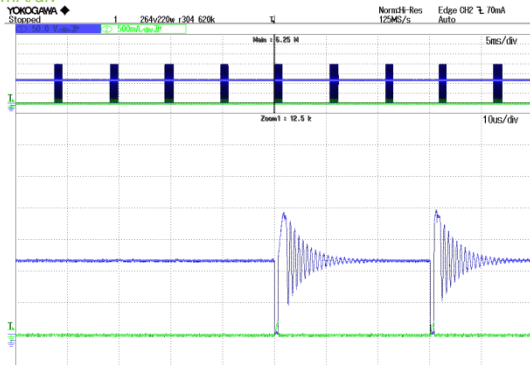

Figure 14. Vds and Idrain
 VIN=90 Vac, IOU=0 A

Time 5 ms/10 μ s
 CH1 100 V/div
 CH2 500 mA/div

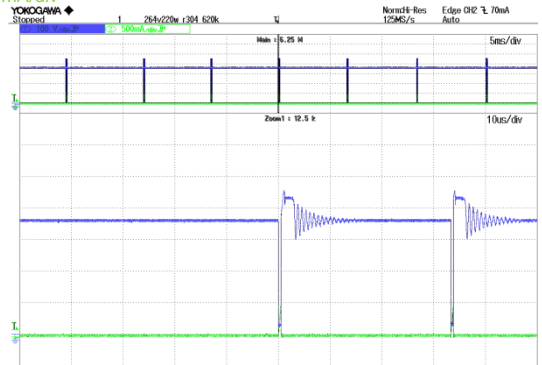

Figure 15. Vds and Idrain
 VIN=264 Vac, IOU=0 A

Time 5 ms/2 μ s
 CH1 50 V/div
 CH2 500 mA/div

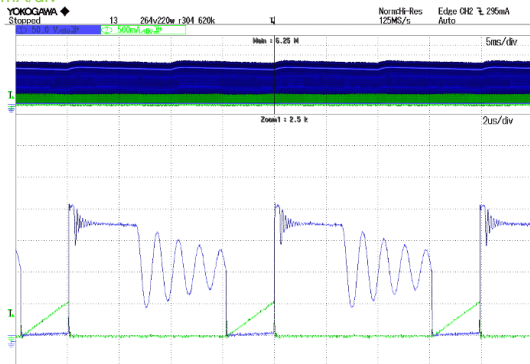

Figure 16. Vds and Idrain
 VIN=90 Vac, IOU=0.5 A

Time 5 ms/2 μ s
 CH1 50 V/div
 CH2 500 mA/div

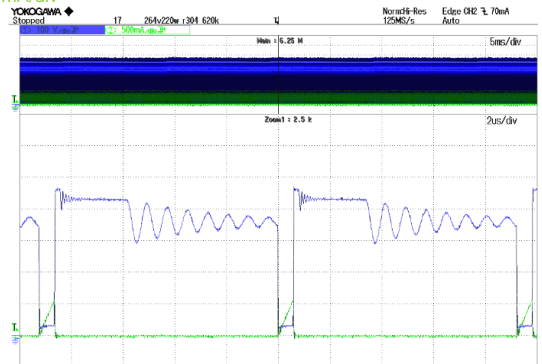

Figure 17. Vds and Idrain
 VIN=264 Vac, IOU=0.5 A

Time 5 ms/2 μ s
 CH1 50 V/div
 CH2 500 mA/div

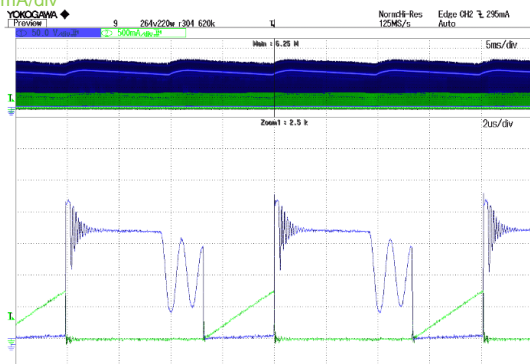

Figure 18. Vds and Idrain
 VIN=90 Vac, IOU=1.0 A

Time 5 ms/2 μ s
 CH1 50 V/div
 CH2 500 mA/div

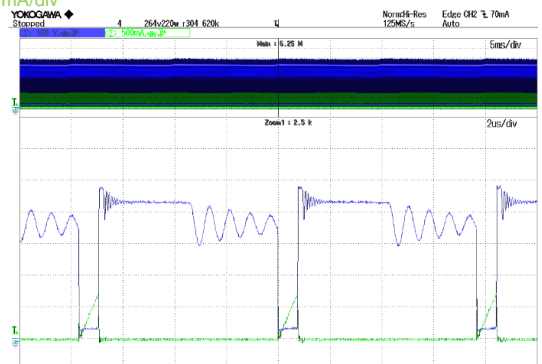

Figure 19. Vds and Idrain
 VIN=264 Vac, IOU=1.0 A

Measurement DATA - Continued

Operation Waveform (Secondary side)

Time 10 μ s
 CH1 DRAIN Voltage 20 V/div
 CH2 DIODE Current 2 A/div

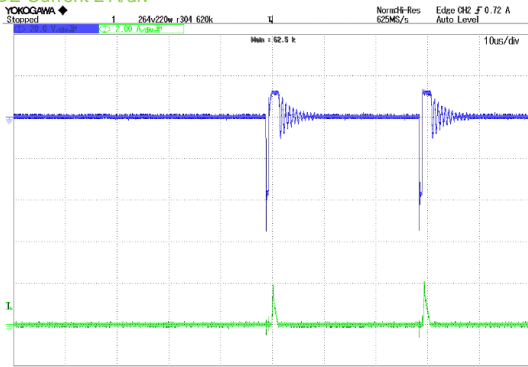

Figure 20. Vds and Idiode
 VIN=90 Vac, IOU=0 A

Time 10 μ s
 CH1 DRAIN Voltage 20 V/div
 CH2 DIODE Current 2 A/div

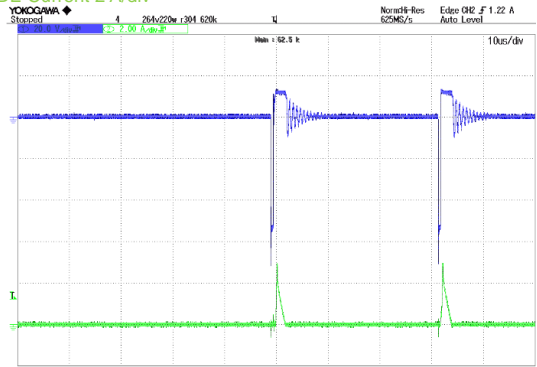

Figure 21. Vds and Idiode
 VIN=264 Vac, IOU=0 A

Time 2 μ s
 CH1 DRAIN Voltage 20 V/div
 CH2 DIODE Current 2 A/div

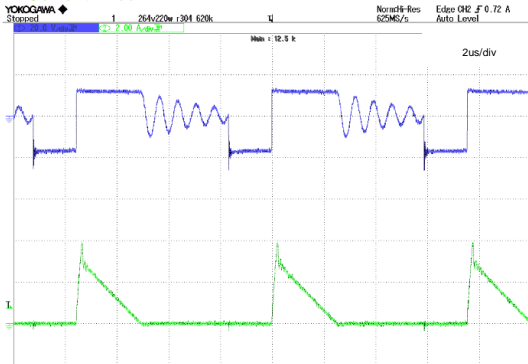

Figure 22. Vds and Idiode
 VIN=90 Vac, IOU=0.5 A

Time 2 μ s
 CH1 DRAIN Voltage 20 V/div
 CH2 DIODE Current 2 A/div

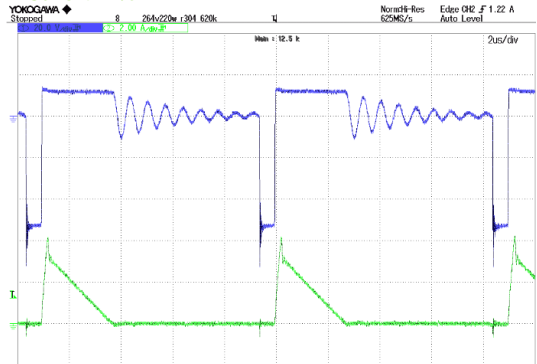

Figure 23. Vds and Idiode
 VIN=264 Vac, IOU=0.5 A

Time 2 μ s
 CH1 DRAIN Voltage 20 V/div
 CH2 DIODE Current 2 A/div

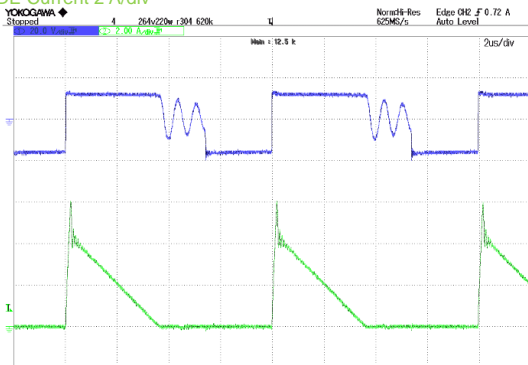

Figure 24. Vds and Idiode
 VIN=90 Vac, IOU=1.0 A

Time 2 μ s
 CH1 DRAIN Voltage 20 V/div
 CH2 DIODE Current 2 A/div

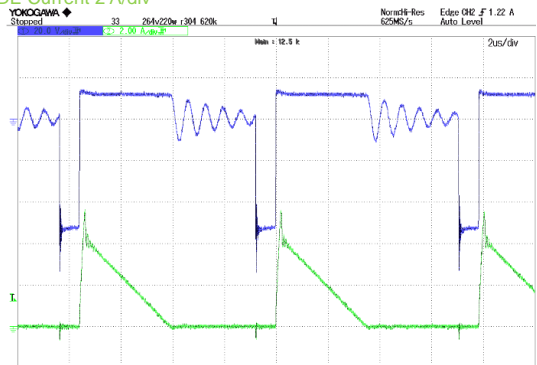

Figure 25. Vds and Idiode
 VIN=264 Vac, IOU=1.0 A

Measurement DATA - Continued

Start Up Waveform (Primary Side)

Time 5 ms/50 μ s
 CH1 DRAIN Voltage 100 V/div
 CH2 FET Current 500 mA/div
 CH3 Output Voltage 5 V/div

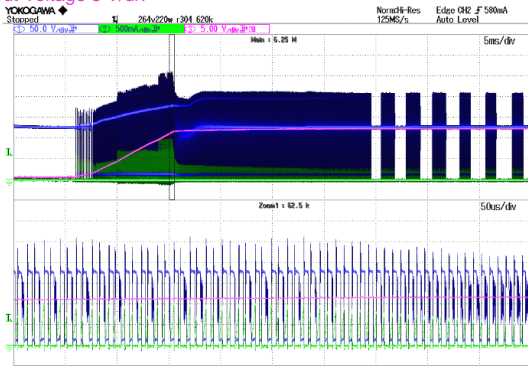

Figure 26. Vds, Idrain and Vout
 VIN=90 Vac, IOU=0 A

Time 5 ms/10 μ s
 CH1 100 V/div
 CH2 500 mA/div
 CH3 Output Voltage 5 V/div

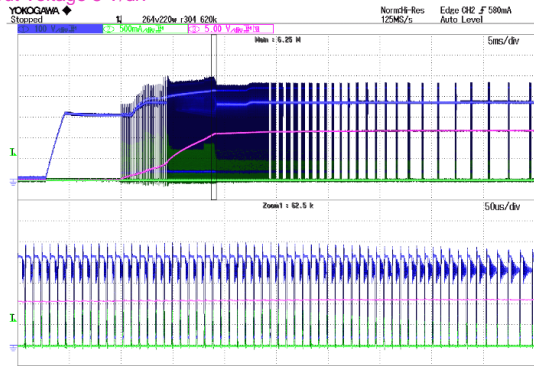

Figure 27. Vds, Idrain and Vout
 VIN=264 Vac, IOU=0 A

Time 5 ms/50 μ s
 CH1 DRAIN Voltage 100 V/div
 CH2 FET Current 500 mA/div
 CH3 Output Voltage 5 V/div

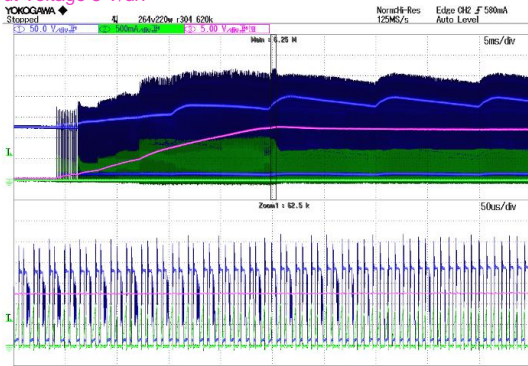

Figure 28. Vds, Idrain and Vout
 VIN=90 Vac, IOU=1.0 A

Time 5 ms/2 μ s
 CH1 50 V/div
 CH2 500 mA/div
 CH3 Output Voltage 5 V/div

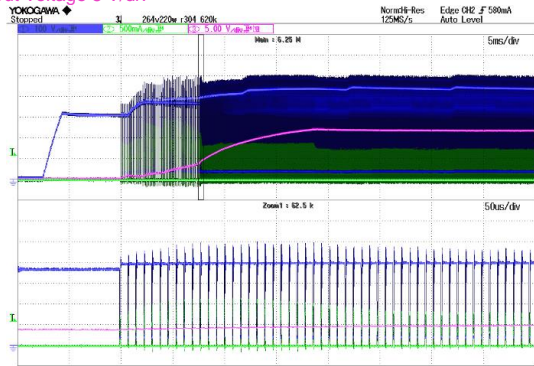

Figure 29. Vds, Idrain and Vout
 VIN=264 Vac, IOU=1.0 A

Measurement DATA - Continued

Dynamic Response

Time 5 ms
CH1 Output Voltage 200 mV/div
CH2 Output Current 500 mA/div

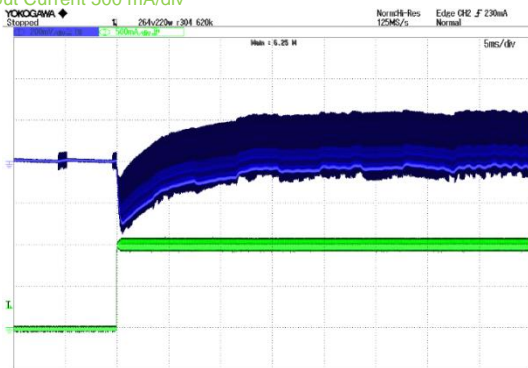

Figure 30. Iout and Vout
VIN=90 Vac, IOU=0 -> 1.0 A

Time 50 ms
CH1 Output Voltage 200 mV/div
CH2 Output Current 500 mA/div

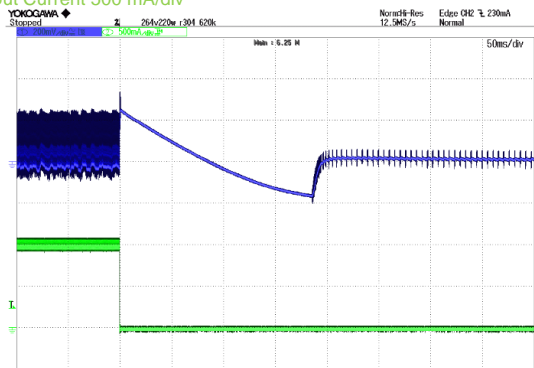

Figure 31. Iout and Vout
VIN=90 Vac, IOU=1.0 -> 0 A

Time 5 ms
CH1 Output Voltage 200 mV/div
CH2 Output Current 500 mA/div

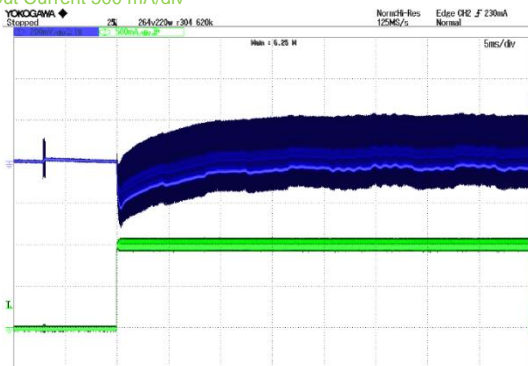

Figure 32. Iout and Vout
VIN=264 Vac, IOU=0 -> 1.0 A

Time 50 ms
CH1 Output Voltage 200 mV/div
CH2 Output Current 500 mA/div

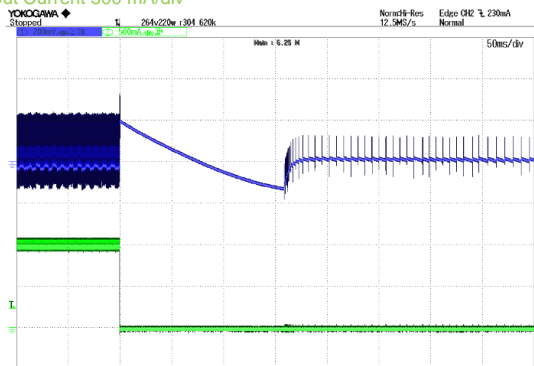

Figure 33. Iout and Vout
VIN=264 Vac, IOU=1.0 -> 0 A

Measurement DATA - Continued

Output ripple Voltage

Time 5 μ s

CH1 Output Voltage 200 mV/div

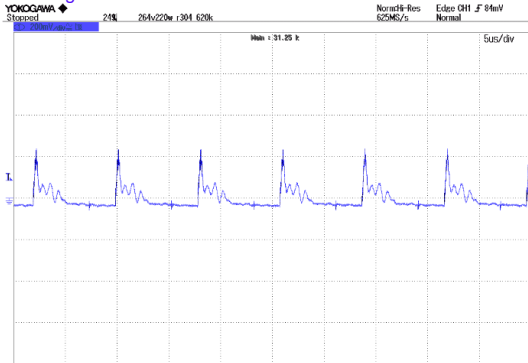

Figure 34. Vout
VIN=90 Vac, IOU=1.0 A

Time 50 μ s

CH1 Output Voltage 200 mV/div

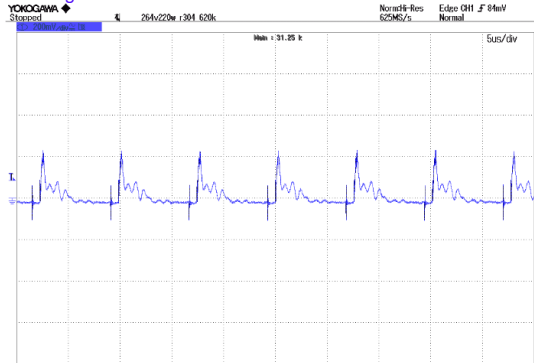
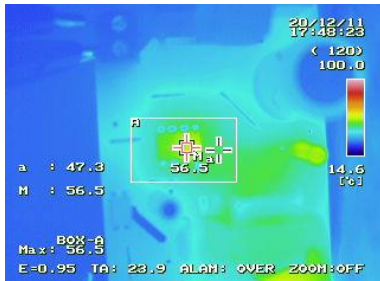
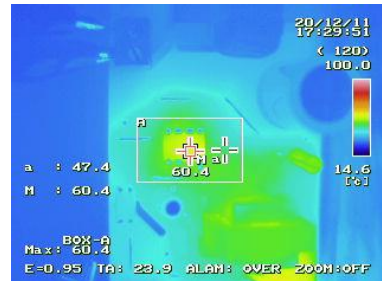

Figure 35. Vout
VIN=264 Vac, IOU=1.0 A

Operating Temperature



IC 56.5 °C



IC 60.4 °C



Transformer 49.7 °C

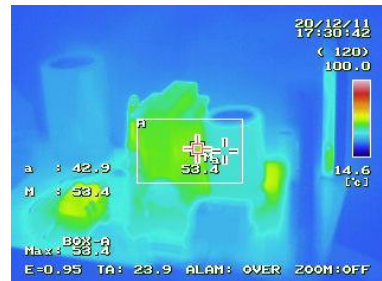

Transformer 53.4 °C

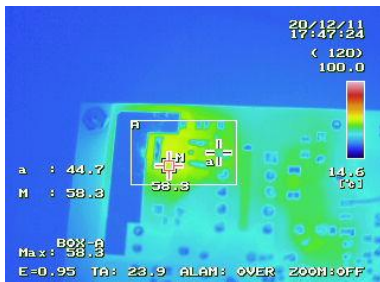

Secondary Side diode 58.3 °C

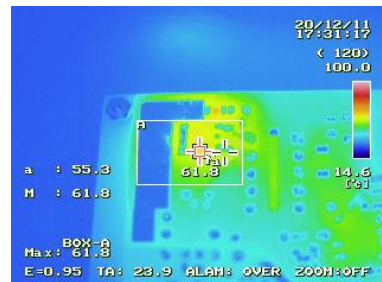

Secondary Side diode 61.8 °C

Figure 36. Thermal Image
VIN = 90 Vac IOU = 1.0 A

Figure 37. Thermal Image
VIN = 264 Vac IOU = 1.0 A

Revision History

Date	Rev.	Changes
1.Feb.2021	001	New Release
May 19, 2021	002	P2 Change Figure. 2 picture. P4 Transformer parts name modified. P5 Transformer information modified.

Notes

- 1) The information contained herein is subject to change without notice.
- 2) Before you use our Products, please contact our sales representative and verify the latest specifications :
- 3) Although ROHM is continuously working to improve product reliability and quality, semiconductors can break down and malfunction due to various factors.
Therefore, in order to prevent personal injury or fire arising from failure, please take safety measures such as complying with the derating characteristics, implementing redundant and fire prevention designs, and utilizing backups and fail-safe procedures. ROHM shall have no responsibility for any damages arising out of the use of our Products beyond the rating specified by ROHM.
- 4) Examples of application circuits, circuit constants and any other information contained herein are provided only to illustrate the standard usage and operations of the Products. The peripheral conditions must be taken into account when designing circuits for mass production.
- 5) The technical information specified herein is intended only to show the typical functions of and examples of application circuits for the Products. ROHM does not grant you, explicitly or implicitly, any license to use or exercise intellectual property or other rights held by ROHM or any other parties. ROHM shall have no responsibility whatsoever for any dispute arising out of the use of such technical information.
- 6) The Products specified in this document are not designed to be radiation tolerant.
- 7) For use of our Products in applications requiring a high degree of reliability (as exemplified below), please contact and consult with a ROHM representative : transportation equipment (i.e. cars, ships, trains), primary communication equipment, traffic lights, fire/crime prevention, safety equipment, medical systems, servers, solar cells, and power transmission systems.
- 8) Do not use our Products in applications requiring extremely high reliability, such as aerospace equipment, nuclear power control systems, and submarine repeaters.
- 9) ROHM shall have no responsibility for any damages or injury arising from non-compliance with the recommended usage conditions and specifications contained herein.
- 10) ROHM has used reasonable care to ensure the accuracy of the information contained in this document. However, ROHM does not warrants that such information is error-free, and ROHM shall have no responsibility for any damages arising from any inaccuracy or misprint of such information.
- 11) Please use the Products in accordance with any applicable environmental laws and regulations, such as the RoHS Directive. For more details, including RoHS compatibility, please contact a ROHM sales office. ROHM shall have no responsibility for any damages or losses resulting non-compliance with any applicable laws or regulations.
- 12) When providing our Products and technologies contained in this document to other countries, you must abide by the procedures and provisions stipulated in all applicable export laws and regulations, including without limitation the US Export Administration Regulations and the Foreign Exchange and Foreign Trade Act.
- 13) This document, in part or in whole, may not be reprinted or reproduced without prior consent of ROHM.



Thank you for your accessing to ROHM product informations.
More detail product informations and catalogs are available, please contact us.

ROHM Customer Support System

<http://www.rohm.com/contact/>