

C1.2*225*245.4*1PCS

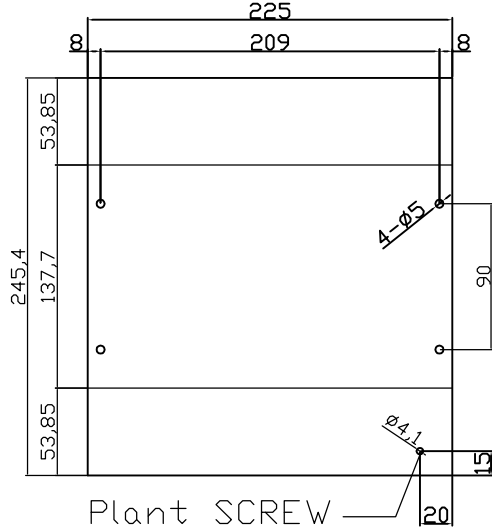

C1.2*169.4*358.1*1PCS

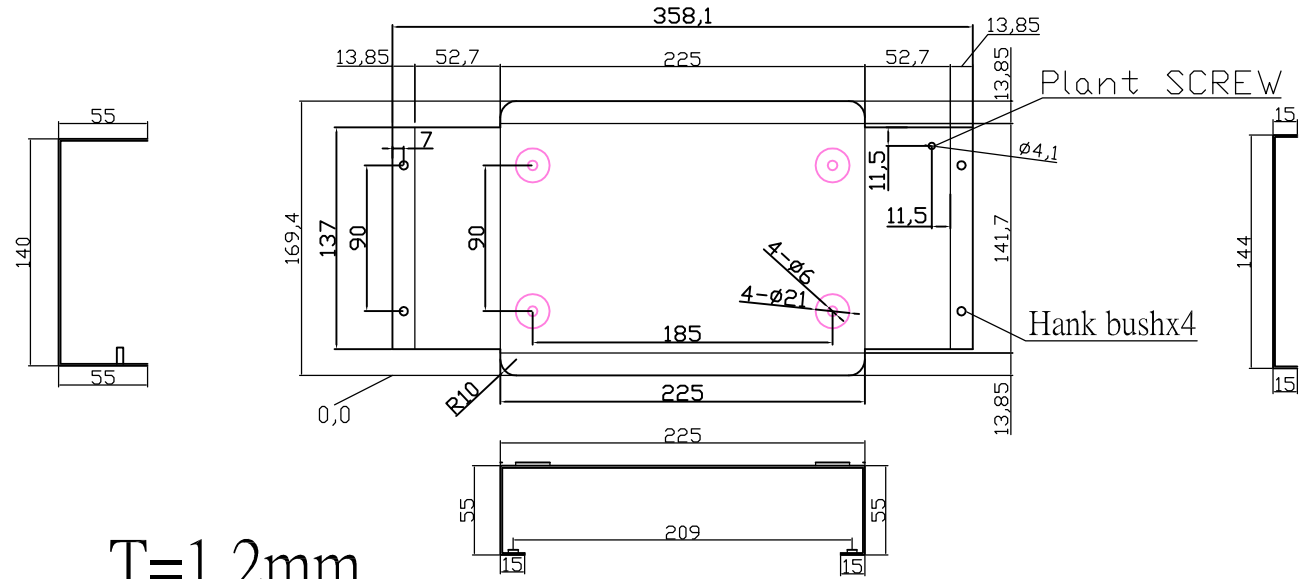

T=1.2mm

Accessory / 配件	MATERIAL / 材質	Quantity / 數量	Type / 型式
Plant SCREWS	Free Cutting Steel-Sulfur	2	M4x10mm
Nut	Free Cutting Steel-Sulfur	2	M4
nut spacer	Free Cutting Steel-Sulfur	2	M4
screws	Free Cutting Steel-Sulfur	4	M4x12.7mm
Hank bush	Free Cutting Steel-Sulfur	4	M4



DIM./單位 mm	DWN./繪圖 周育傑	DATE./日期 2006/11/02	ITEM/產品名稱 232248
IE.NO./客戶型號	CHK./審查	DATE./日期	
MATERIAL/材質 SHEET STEEL	APPN./核准	DATE./日期	DWG. NO./圖號 GG5247