



Brand of NTN Group

Technical data

US201-08G2

Insert bearings



Spherical outer diameter, fixing by socket set screw, single lip seal

VISUAL (S)

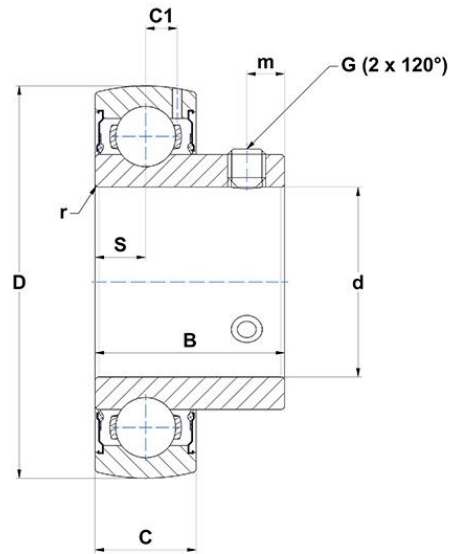

PRODUCT DEFINITION

Brand	SNR
B - Width of Inner Ring	22 mm
C - Width of Outer Ring	12 mm
C1 - Distance center of OR to center of lubrication zone	3,6 mm
d - Shaft diameter	12,7 mm
D - Outer diameter of OR	40 mm
G - Set screw size	10-32UNF
m - Distance to set screw	4 mm



NTN Europe

1 rue des Usines · BP 2017 · 74010 Annecy Cedex · France · Tel. +33 (0)4 50 65 30 00
 S.A. au capital de 322 639 919 € · RCS ANNECY B 325 821 072 · Id. Fiscale : FR 48 325 821 072
 SIRET 325 821 072 00015 · Code APE 2815 Z · Code NACE 28.15

PRODUCT DEFINITION

r - Radius Inner Ring	0.6
S - Distance front side/bearing centre	6 mm
f0 - Factor	13.2
SW - Wrench size	2,381 mm

PRODUCT PERFORMANCE

C - Dynamic load rating	9550000 mN
C0 - Static load rating	4780000 mN
Operating temperature min.	253,15 °K
Operating temperature max.	373,15 °K

OTHER FEATURES

Mass	0,09 kg
Recommended tightening torque for set screw	3.2 N-m

BEARING FREQUENCIES

BPFO - Over rolling frequency on outer ring (60 rpm)	3.06937931034483 Hz
BPMF - Over rolling frequency on inner (60 rpm)	4.93062068965517 Hz
BSF - Over rolling frequency on rolling element (60 rpm)	4.06555143793155 Hz
BRF - Rotational frequency - rolling element (60 rpm)	2.03277571896577 Hz
FTF - Rotational frequency - cage (60 rpm)	0.383672413793103 Hz

