

Datasheet

Industrial cabled box 9 modules 2 shucko sockets 16A 2P+T + 2 industrial sockets 16A 3P+T

Stock No: 2144283



Image for reference only

Technical Characteristics

Rated Current:	-
Rated Voltage	400V
Rated Short-Circuit Conditional Current	-
Rated Frequency	50/60Hz
Insulating Resistance	>10MΩ@500Vdc
Dielectric Stength	2kV 60s
IP Protection Degree	IP44 (IEC / EN 60529)
IK Protection Degree	IK08 (IEC / EN 62262)
Operating Temperature	-25°C/ 40°C
Glow Wire Test	850°C live parts supports /650°C other parts
Earthing System	-
Protection Class	Enclosure Class II (Isolated) Circuits Class I (Earth)
Product Standard	IEC 62208 CEE 7 Standard Sheet III IEC/EN 60309-1, IEC/EN 60309-2
Dimensions	320x205x175 mm
Weight	1,74 kg

Built-in Components

- 2 x Socket-outlet: 16A 230V 3P+T IEC 60309
- 2 x Socket-outlet: 16A 230V 2P+T Shucko Type F

Enclosure Sketch

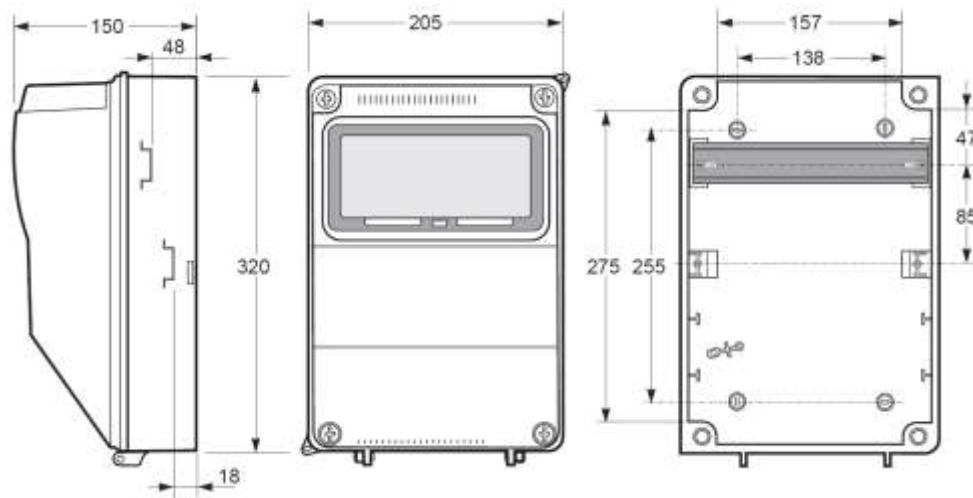

Dimensions in mm

Atmospheric conditions of utilisation

Ambient air temperature in which the distribution box operates must be between -25°C and $+40^{\circ}\text{C}$. Relative humidity of the air should not exceed 50% at a maximum temperature of 40°C . However, higher degrees of relative humidity are allowed at lower temperatures, reaching a maximum relative humidity of 100% for a temperature of 25°C . Equipment locations where condensation may occur should be avoided.

	<p>In the event of condensation on the electrical equipment (near live parts), no voltage should be applied to the distribution box.</p>
---	---

During transport & storage the temperature can be allowed to reach an extreme value between -25°C and 55°C .

	<p>Installation, commissioning, inspection and maintenance operations may only be performed by suitably qualified personnel trained in applicable electrical and safety subjects.</p> <p>Compliance with the safety instructions does not excuse compliance with other specific regulations of the facility, place, country or other circumstances affecting the equipment.</p>
--	---

Installation

The equipment has been designed to be installed on a vertical plane or on a specially dedicated metal support. The installation surface must be able to withstand stresses due to the equipment's own weight.

	<p>Do not install the equipment on a surface of flammable material, or in environments that may be under the influence of corrosive products.</p> <p>Special attention should be paid to equipment located around the box so that it does not adversely affect ventilation.</p>
---	---

Recommended fixing screw:

- Diameter: 4mm
- Minimum depth: 25mm
- Tightening torque: 4Nm

Inspection and maintenance

	<p>Prior to access to the interior of the distribution box, disconnect from the power supply and check that there is no voltage before starting any operation inside. Use measuring equipment of category III-600 Volts to check absence of voltage.</p>
---	---

Annually recommended:

- Perform a visual inspection of the enclosure. Look for cracks or bumps that may affect the normal operation of the frame and the designated IP.
- Perform a visual inspection of the fastenings and electrical connections. Loose connections should be specially searched and consequently tightened.

Operation

	<p>Do not handle inside the box while there are live parts.</p> <p>Do not disconnect or connect any terminal while the equipment is under voltage.</p>
---	--

Tasks to be carried out by properly instructed personnel:

- Connecting / disconnecting power outlets
- Switchgear operation (switches, differentials, etc.)
- External visual inspection

	<p>This company is not responsible for the consequential damages of an improper use of its equipment.</p>
---	--