

- 1 MATERIAL: HOUSING AND COVER ARE HIGH TEMPERATURE THERMOPLASTIC, LIQUID CRYSTAL POLYMER (LCP), COLOR: NATURAL, FOR 1-5916783-5, 1-5916783-8 AND 3-5916783-5, COVER IS BLACK. LP SLZ LEVER MATERIAL IS STAINLESS STEEL. CONTACT MATERIAL IS COPPER ALLOY.
- 2 FINISH: CONTACT AREA-GOLD THICKNESS PER TABLE OVER 0.00381[.000150] MIN. THICK NICKEL PLATE. SOLDERTAIL- 0.00381-0.00635 [.000150-.000250] MIN. THICK TIN OVER 0.00127[.000050] MIN. THICK NICKEL PLATE. CONTACT AREA SHALL BE FREE OF LUBRICANT.
- 3 PRODUCT LINE: LOW PROFILE SINGLE LEVER ZIF (LP SLZ). PRODUCT SPEC 108-1572, APPLICATION SPEC 114-1100.
- 4 PRODUCT LINE: LOW PROFILE SCREWDRIVER ACTUATED ZIF (LP SAZ). PRODUCT SPEC 108-1572-1, APPLICATION SPEC 114-1105, INSTRUCTION SHEET 408-3355.
- 5 PRODUCT CONFORMS TO NOTE 4 EXCEPT DURABILITY PER PRODUCT SPECIFICATION IS 20 CYCLES AND SMALL INDENTATIONS IN SCREWDRIVER SLOTS PERMISSIBLE AFTER ACTUATION.
- 6 DATE CODE MAY VARY IN LOCATION AND FORMAT DEPENDING ON MANUFACTURING LOCATION.
- 7 THESE PRODUCTS COMPLY WITH SPEC. 202-38 "PRODUCT AND PROCESS GUIDELINES FOR ROHS COMPATIBILITY AND COMPLIANCE".
- 9 OBSOLETE PARTS: OBSOLETE CIS STREAMLINING PER D. RENAUD/ D. SINISI.

REMARKS	DRAWING	TRAY PACKAGED NUMBER OF SOCKETS PER SHIPPING BOX	POSITIONS	SOLDERTAIL LENGTH DIM A±0.25 [±.010]	MIN GOLD THICKNESS 2	FC-PGA/PPGA	HANDLE STYLE	PRODUCT LINE	PART NUMBER
OBSOLETE 9	SEE SHEET 6	160	370	2.03 [.080]	0.00076 [.000030]	FLIP CHIP PGA (FC-PGA) OR PPGA	-	LP SAZ 4 5	6-5916783-1
	SEE SHEET 5	160	370	2.79 [.110]	0.00038 [.000015]	PLASTIC PGA (PPGA)	-	LP SAZ 4	5-5916783-6
OBSOLETE	SEE SHEET 5	160	370	2.36 [.093]	0.00038 [.000015]	PLASTIC PGA (PPGA)	-	LP SAZ 4	5-5916783-5
OBSOLETE 9	SEE SHEET 5	160	370	2.36 [.093]	0.00076 [.000030]	PLASTIC PGA (PPGA)	-	LP SAZ 4	5-5916783-2
	SEE SHEET 4	160	370	3.56 [.140]	0.00038 [.000015]	PLASTIC PGA (PPGA)	-	LP SAZ 4	4-5916783-7
	SEE SHEET 4	160	370	2.79 [.110]	0.00038 [.000015]	PLASTIC PGA (PPGA)	-	LP SAZ 4	4-5916783-6
	SEE SHEET 4	160	370	2.36 [.093]	0.00038 [.000015]	PLASTIC PGA (PPGA)	-	LP SAZ 4	4-5916783-5
	SEE SHEET 4	160	370	2.36 [.093]	0.00076 [.000030]	PLASTIC PGA (PPGA)	-	LP SAZ 4	4-5916783-2
	SEE SHEET 3	90	371	2.36 [.093]	0.00038 [.000015]	PLASTIC PGA (PPGA)	LOW PROFILE	LP SLZ 3	3-5916783-5
	SEE SHEET 3	90	370	2.36 [.093]	FLASH	FLIP CHIP PGA (FC-PGA) OR PPGA	LOW PROFILE	LP SLZ 3	1-5916783-8
OBSOLETE	SEE SHEET 3	60	370	2.36 [.093]	0.00038 [.000015]	FLIP CHIP PGA (FC-PGA) OR PPGA	JOG	LP SLZ 3	1-5916783-5
OBSOLETE 9	SEE SHEET 2	90	370	2.79 [.110]	FLASH	FLIP CHIP PGA (FC-PGA) OR PPGA	LOW PROFILE	LP SLZ 3	2-5916783-9
OBSOLETE	SEE SHEET 2	90	370	2.36 [.093]	FLASH	FLIP CHIP PGA (FC-PGA) OR PPGA	LOW PROFILE	LP SLZ 3	2-5916783-8
OBSOLETE 9	SEE SHEET 2	90	370	2.03 [.080]	FLASH	FLIP CHIP PGA (FC-PGA) OR PPGA	LOW PROFILE	LP SLZ 3	2-5916783-7
OBSOLETE	SEE SHEET 2	90	370	2.79 [.110]	0.00038 [.000015]	FLIP CHIP PGA (FC-PGA) OR PPGA	LOW PROFILE	LP SLZ 3	2-5916783-6
AVAILABLE	SEE SHEET 2	90	370	2.36 [.093]	0.00038 [.000015]	FLIP CHIP PGA (FC-PGA) OR PPGA	LOW PROFILE	LP SLZ 3	2-5916783-5
RESTRICTED TO INTEL; OBSOLETE	SEE SHEET 2	90	370	2.03 [.080]	0.00038 [.000015]	FLIP CHIP PGA (FC-PGA) OR PPGA	LOW PROFILE	LP SLZ 3	2-5916783-4
AVAILABLE	SEE SHEET 2	90	370	2.79 [.110]	0.00076 [.000030]	FLIP CHIP PGA (FC-PGA) OR PPGA	LOW PROFILE	LP SLZ 3	2-5916783-3
	SEE SHEET 2	90	370	2.36 [.093]	0.00076 [.000030]	FLIP CHIP PGA (FC-PGA) OR PPGA	LOW PROFILE	LP SLZ 3	2-5916783-2
OBSOLETE 9	SEE SHEET 2	90	370	2.03 [.080]	0.00076 [.000030]	FLIP CHIP PGA (FC-PGA) OR PPGA	LOW PROFILE	LP SLZ 3	2-5916783-1
OBSOLETE	SEE SHEET 2	90	370	3.56 [.140]	0.00076 [.000030]	FLIP CHIP PGA (FC-PGA) OR PPGA	LOW PROFILE	LP SLZ 3	2-5916783-0

<small>THIS DRAWING IS A CONTROLLED DOCUMENT FOR AMP INCORPORATED. ALL IS SUBJECT TO CHANGE. THE CONTROL LINE NUMBERING ORGANIZATION SHOULD BE CONTACTED FOR THE LATEST REVISION.</small>		DWN: WYLEE CHE: VINCENT TAN APD: SE LEONG PRODUCT SPEC APPLICATION SPEC SEE TABLE SEE TABLE WEIGHT: - CUSTOMER DRAWING	15DEC2004 NAME: SOCKET ASSEMBLY, LOW PROFILE, ZIF PGA, 19 X 19 GRID SIZE: A1 CAGE CODE: 00779 DRAWING NO: C-5916783 SCALE: 3:1 SHEET 1 OF 6 REV PI
DIMENSIONS: mm [INCHES] 	TOLERANCES UNLESS OTHERWISE SPECIFIED: 0 PLC ± 1 PLC ±.001 2 PLC ±.001, .0012 3 PLC ± 4 PLC ± ANGLES ± FINISH	TE CONNECTIVITY Singapore	

LOC		DIST		REVISIONS			
NO	DATE	BY	APPD	DESCRIPTION	DATE	BY	APPD
DY				SEE TABLE			

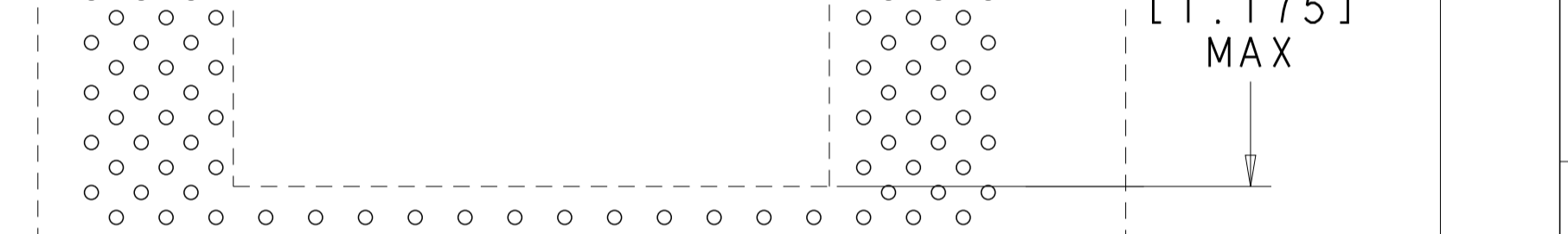
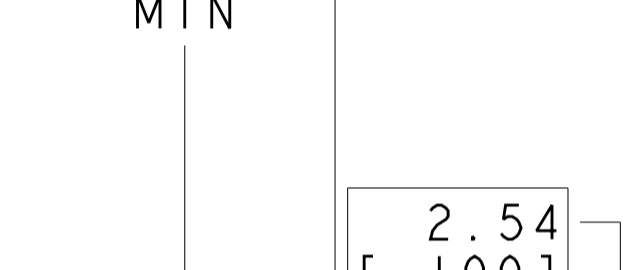
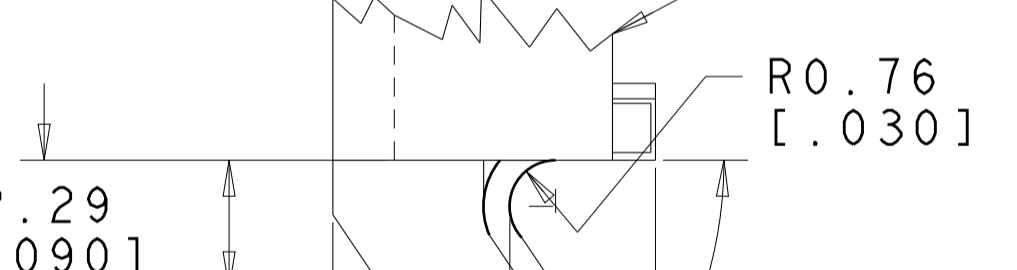
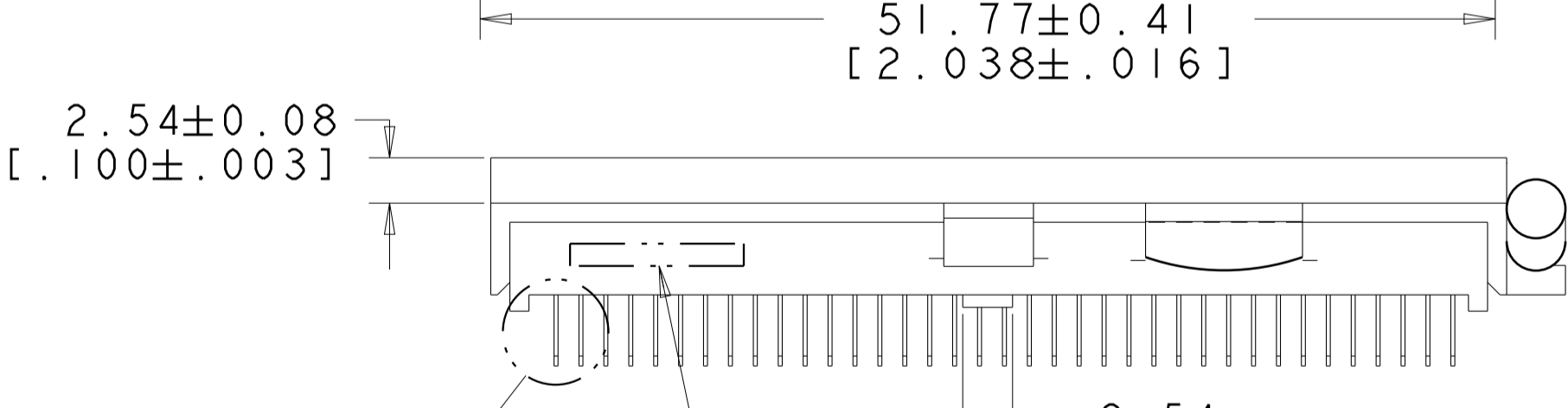
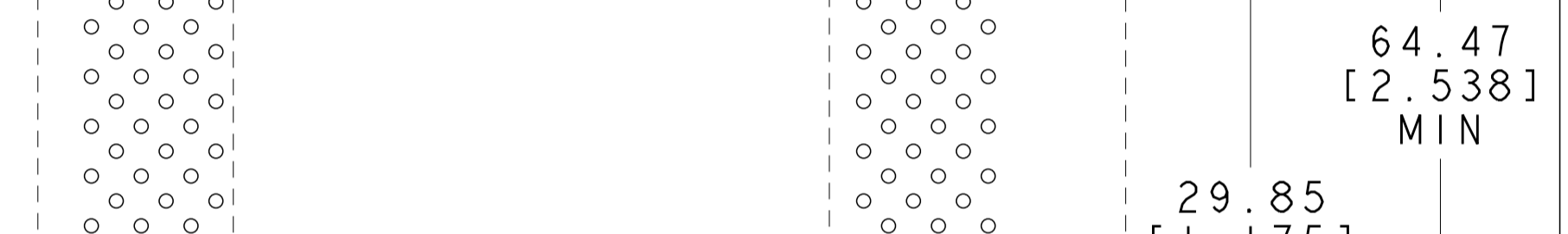
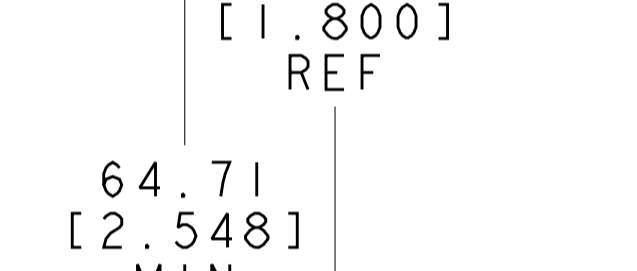
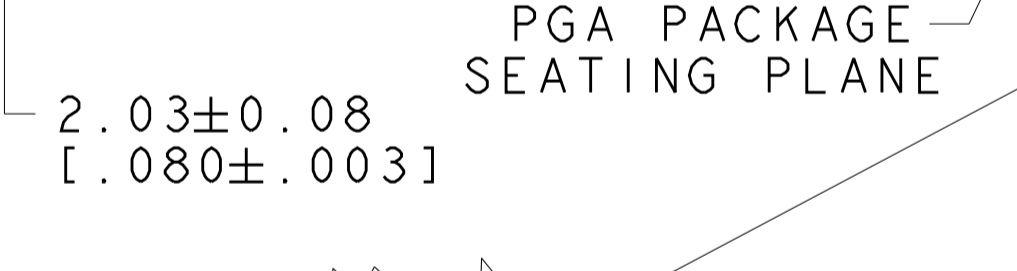
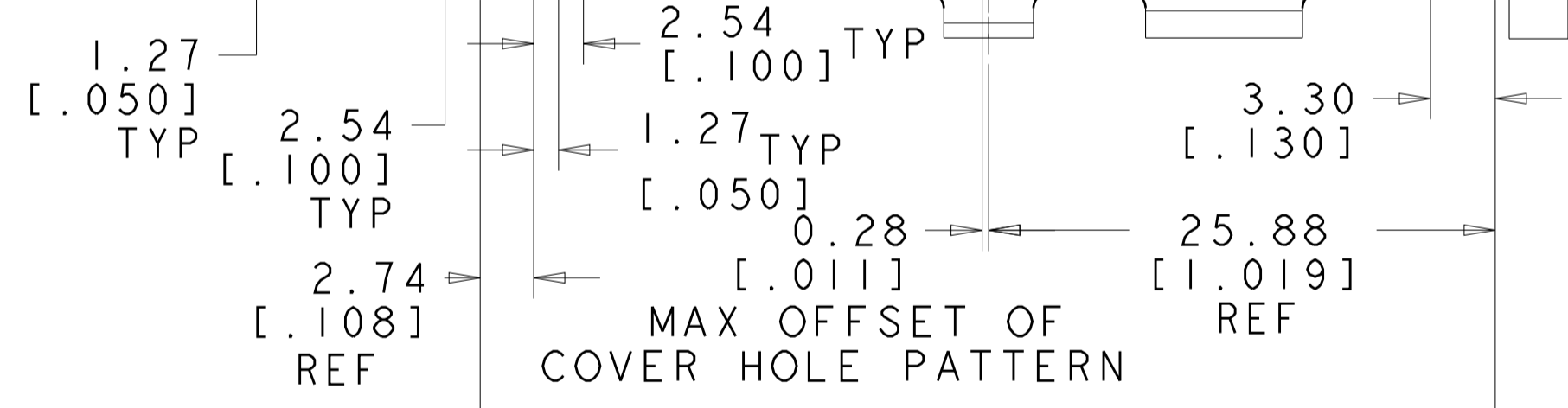
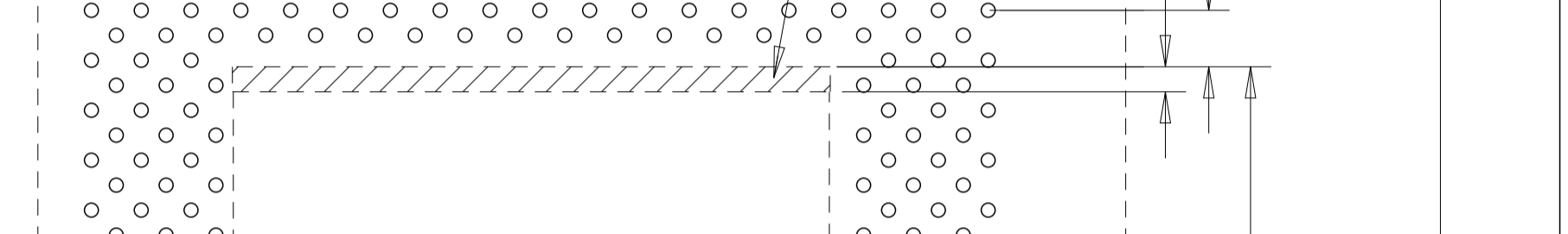
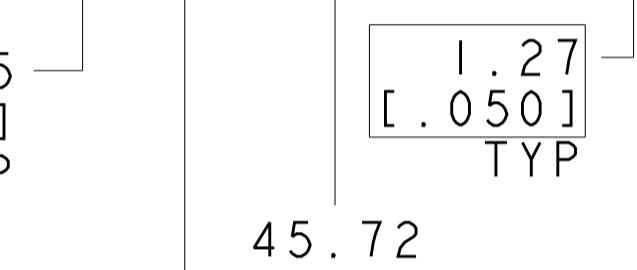
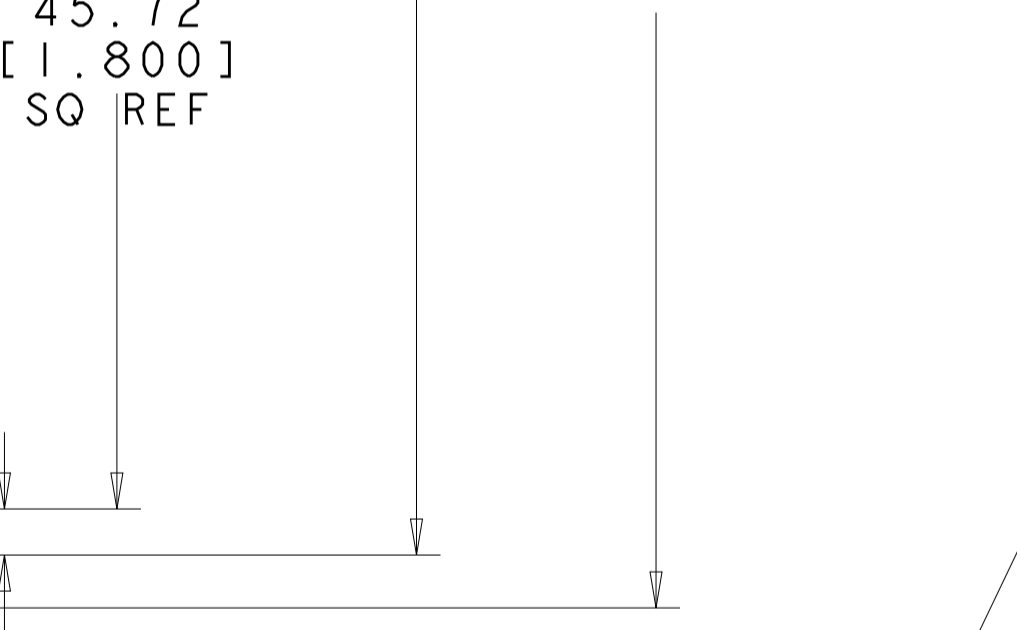
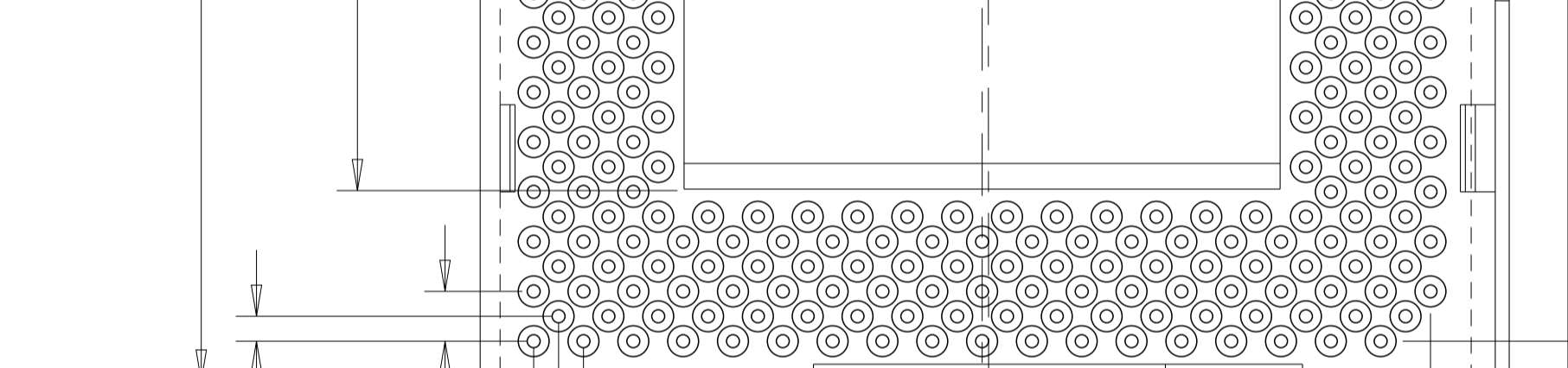
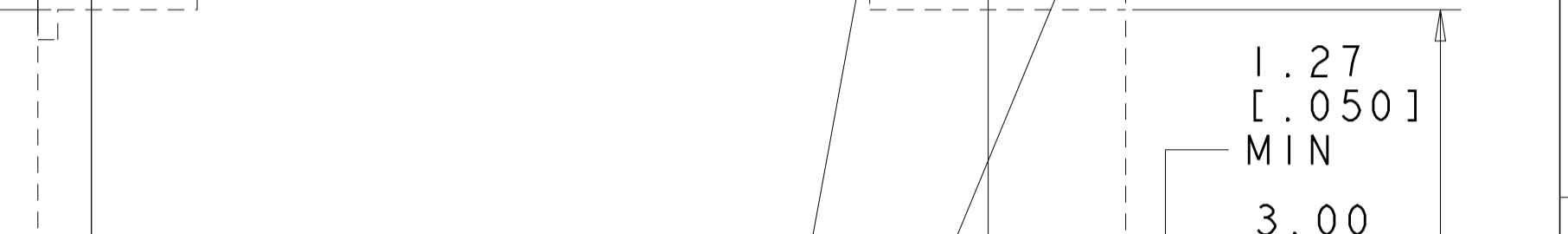
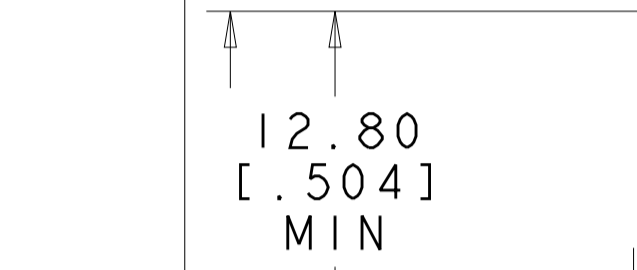
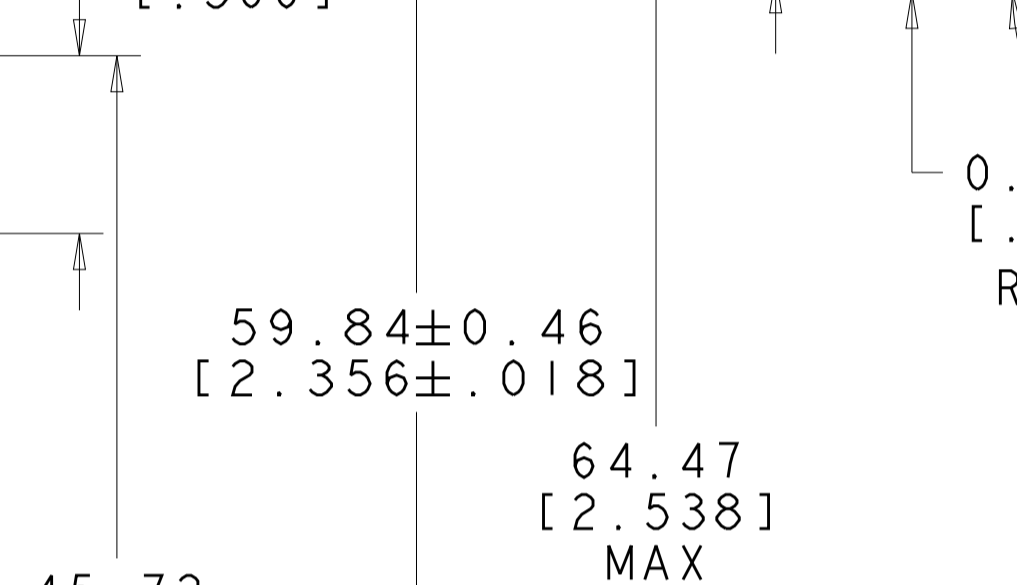
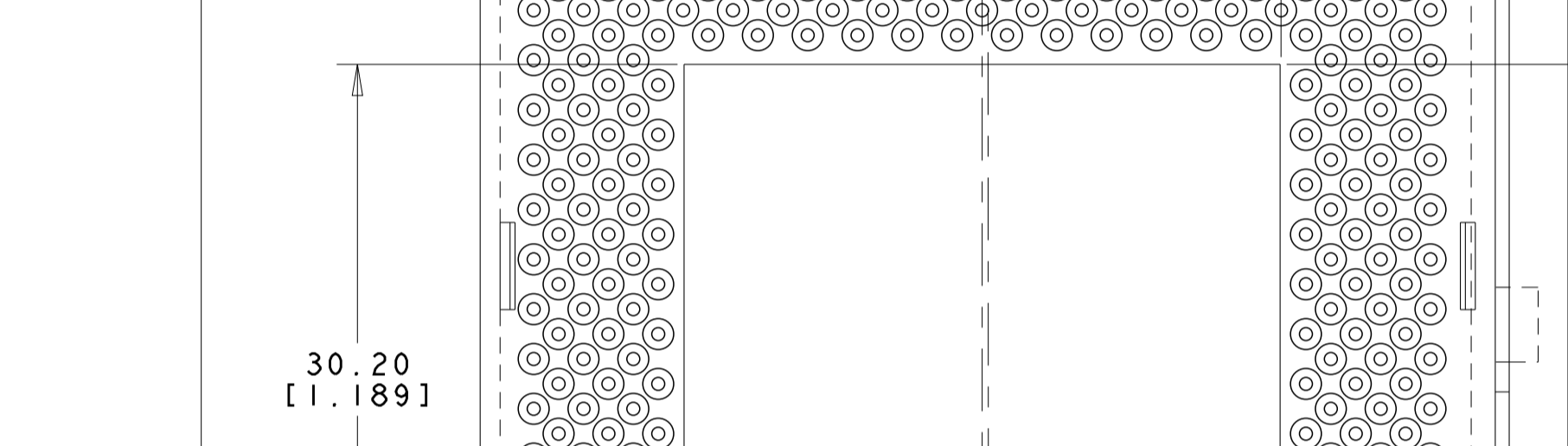
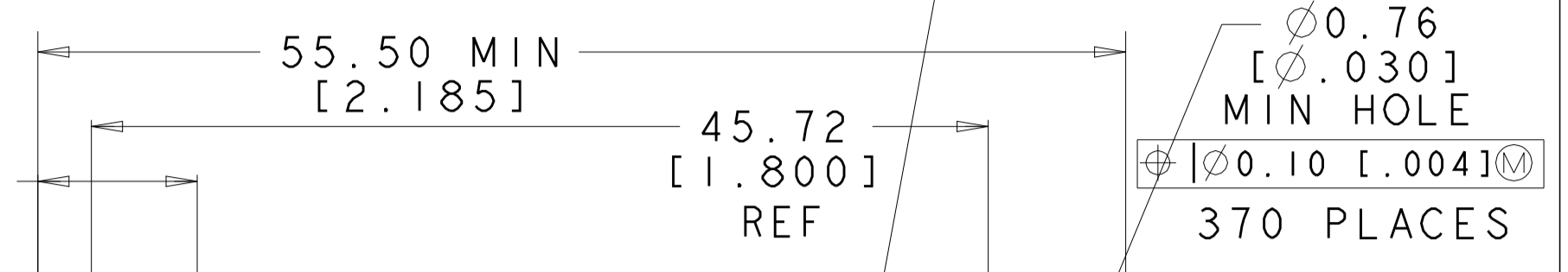
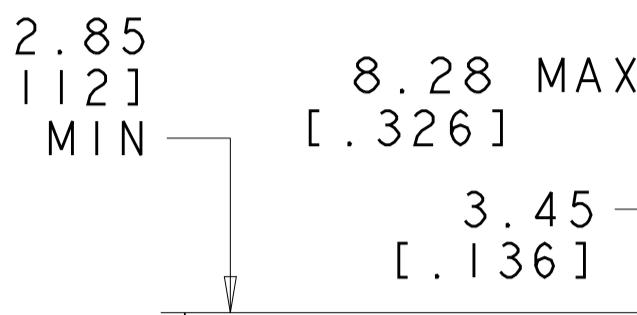
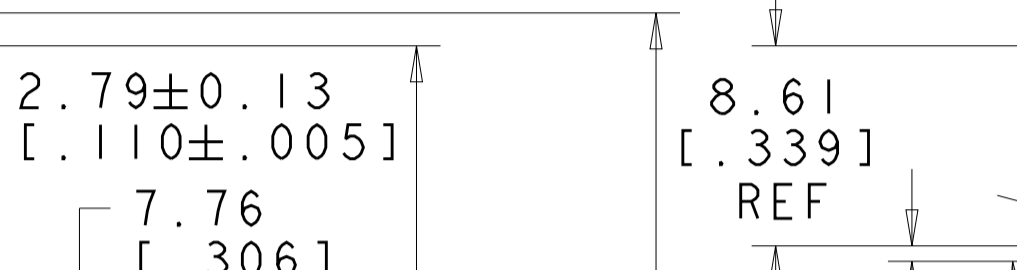
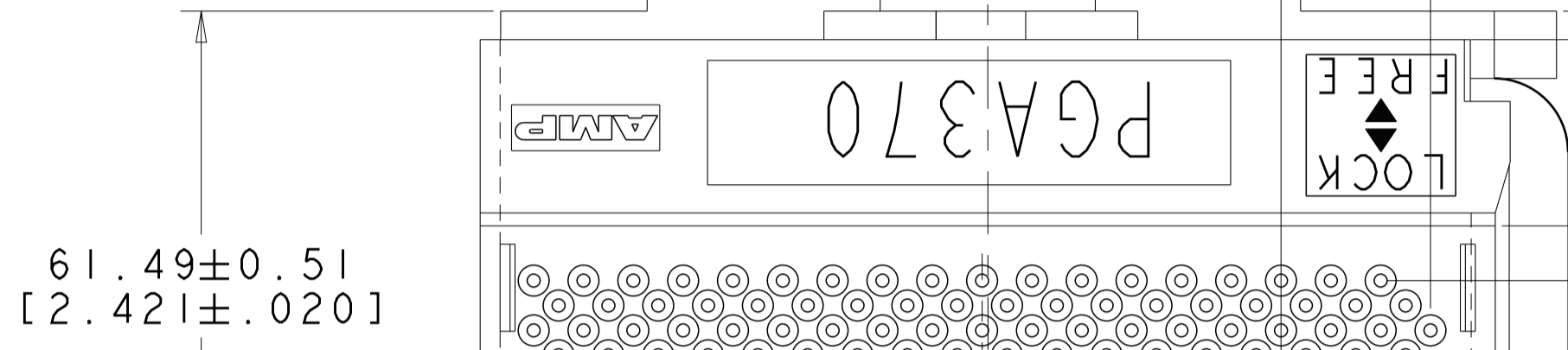
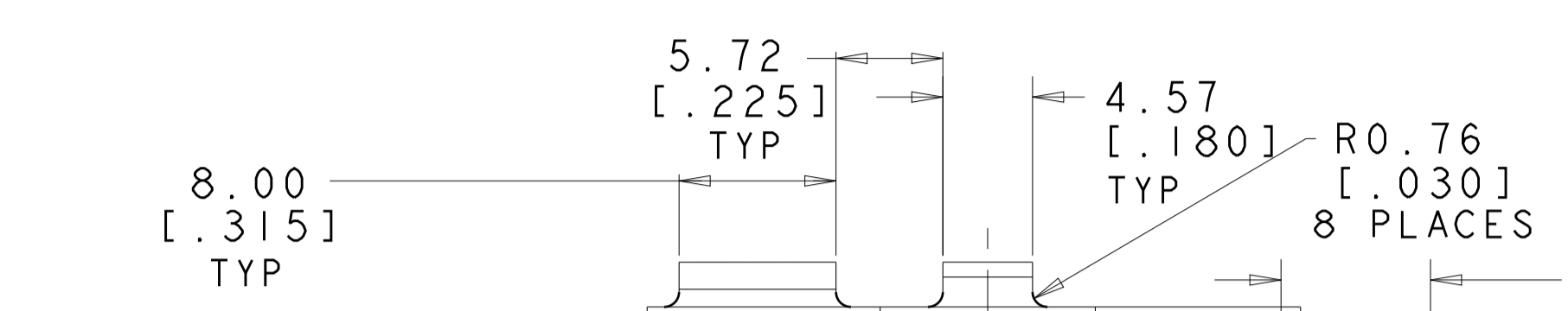
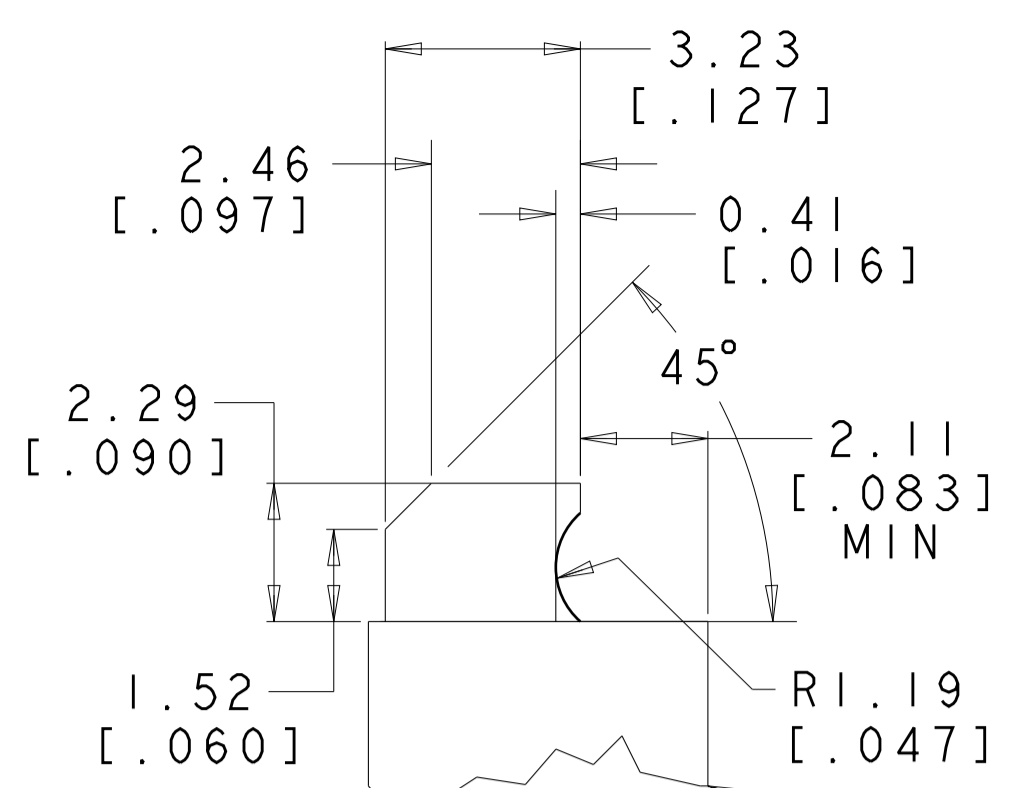
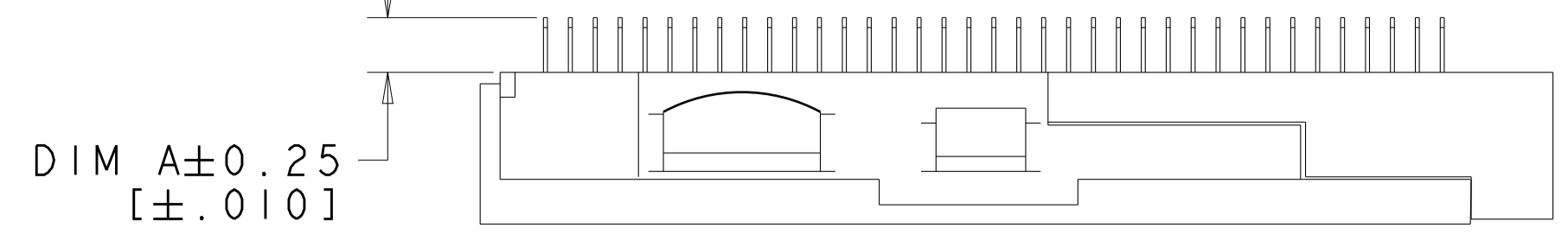

PART NUMBERS 2-5916783-1 THRU 2-5916783-9

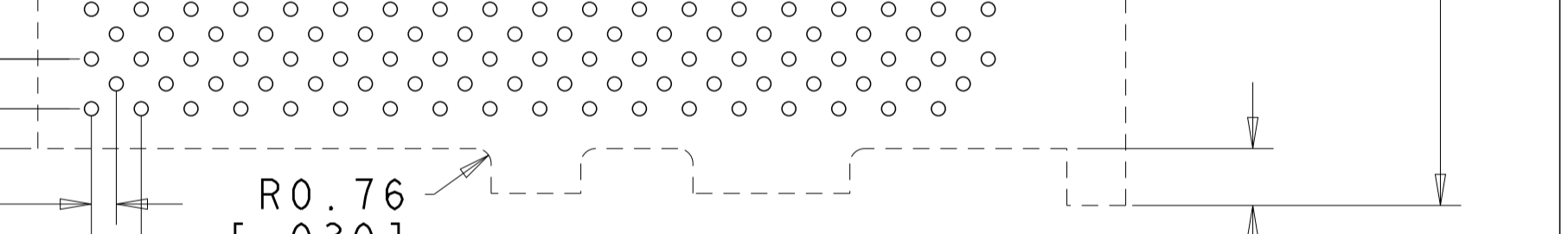
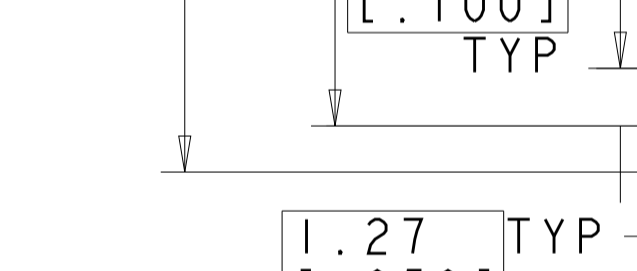
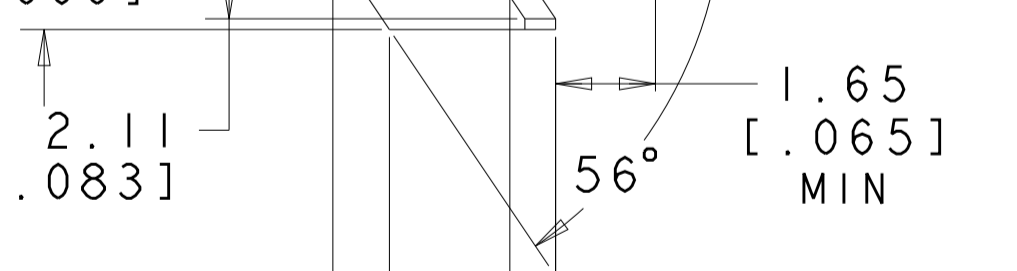

DIMENSIONS: mm [INCHES]		TOLERANCES UNLESS OTHERWISE SPECIFIED:		DWG: WYLEE 15DEC2004 CHK: VINCENT TAN APPD: SE LEONG PRODUCT SPEC APPLICATION SPEC SEE TABLE WEIGHT CUSTOMER DRAWING		TE CONNECTIVITY Singapore	
0 PLC	±	1 PLC	±	NAME	SOCKET ASSEMBLY, LOW PROFILE, ZIF PGA, 19 X 19 GRID	SIZE	A1
2 PLC	±	3 PLC	±	DATE	15DEC2004	CAGE CODE	00779
4 PLC	±	5 PLC	±	DRAWING NO	5916783	DRAWING NO	5916783
ANGLES	±	FINISH	±	SCALE	3:1	SHEET	2 of 6
						REV	

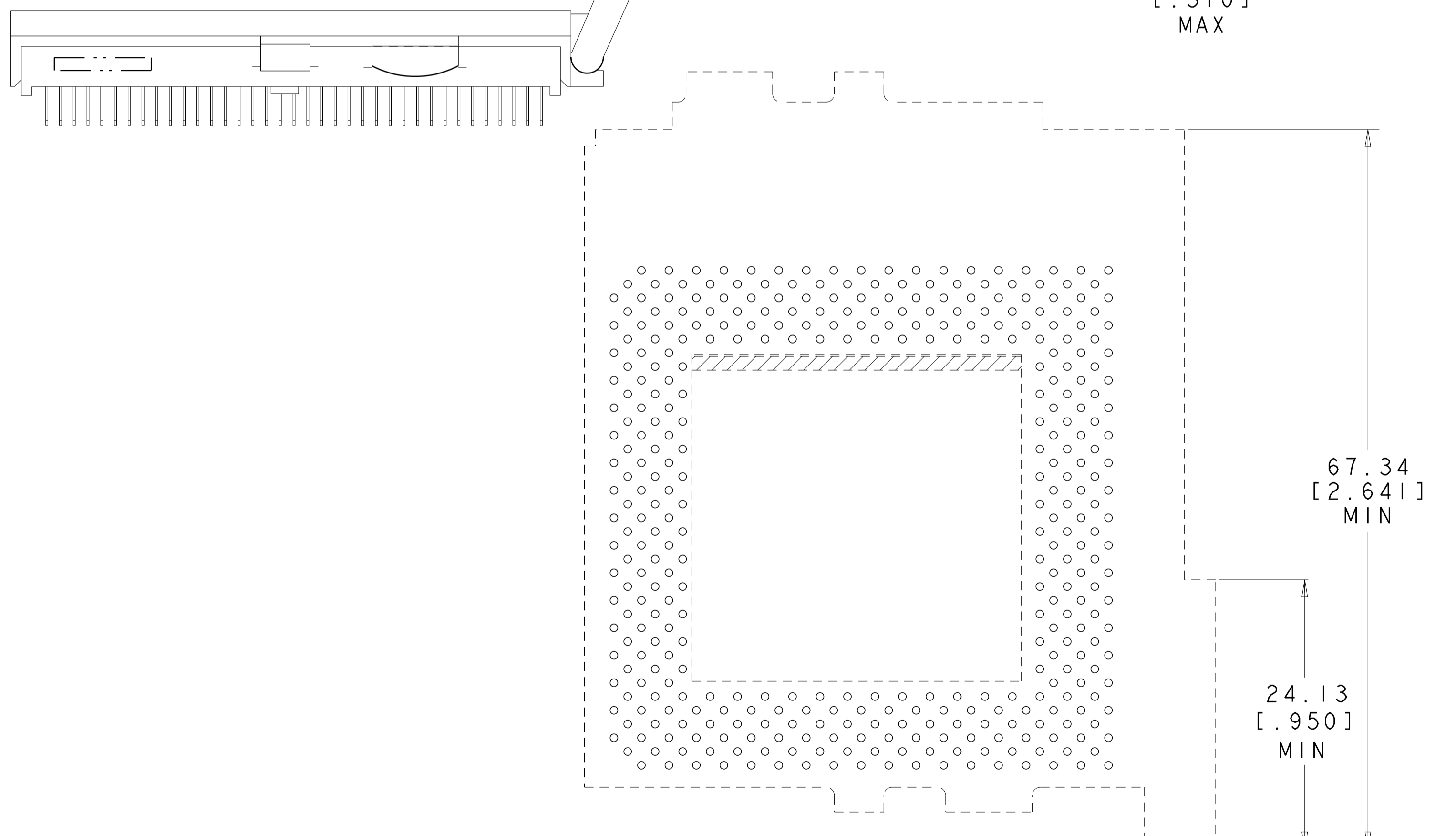
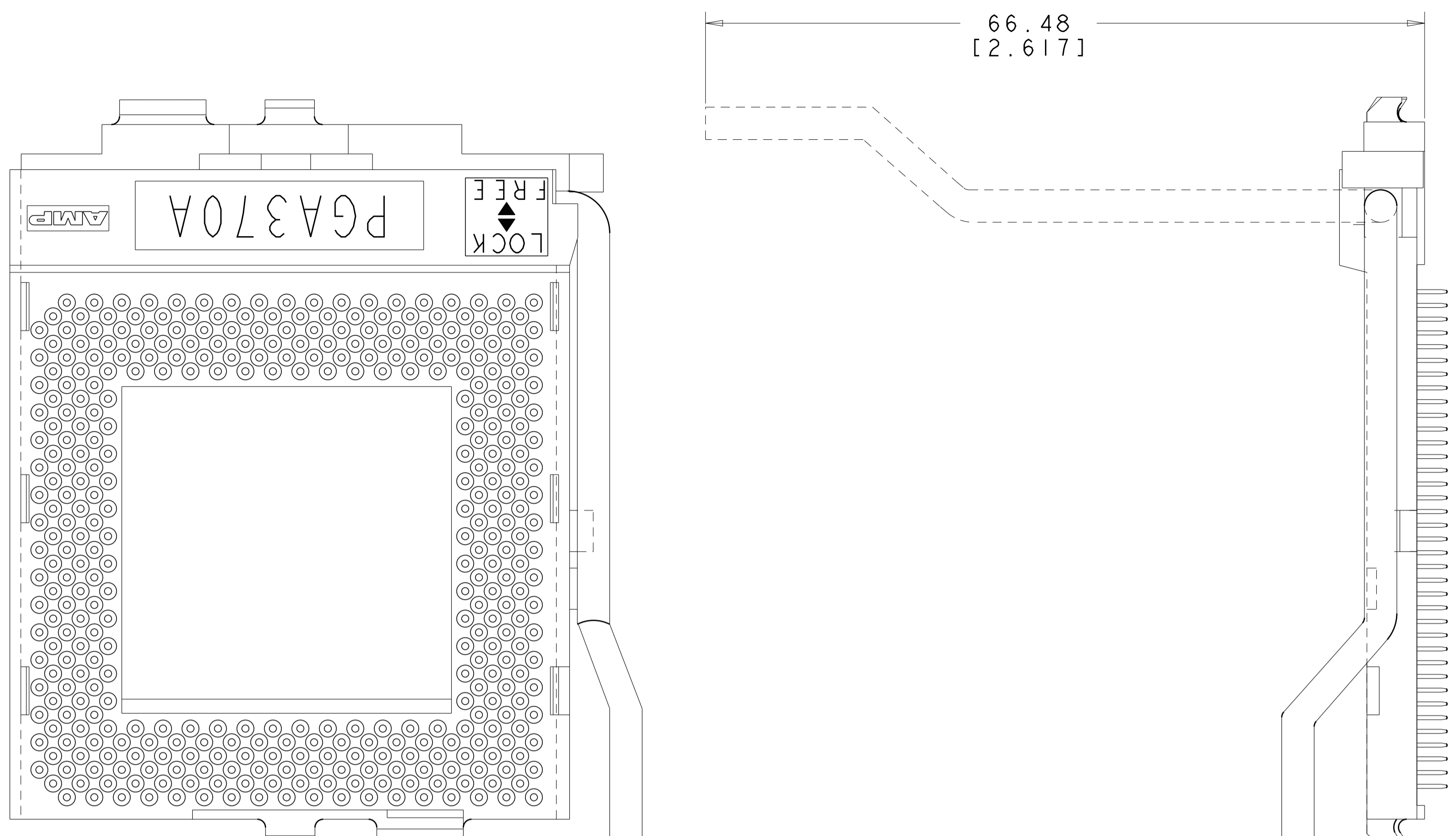

RECOMMENDED PCB HOLE LAYOUT  
 PART NUMBER 1-5916783-5  
 EXCEPT ROTATED PATTERN, PGA370A LOGO AND HANDLE, ALL OTHER DETAILS SAME AS ON SHEET 2.

LOC	DIST	REVISIONS			
NO	DATE	DESCRIPTION	DATE	BY	APPD
1		SEE TABLE			

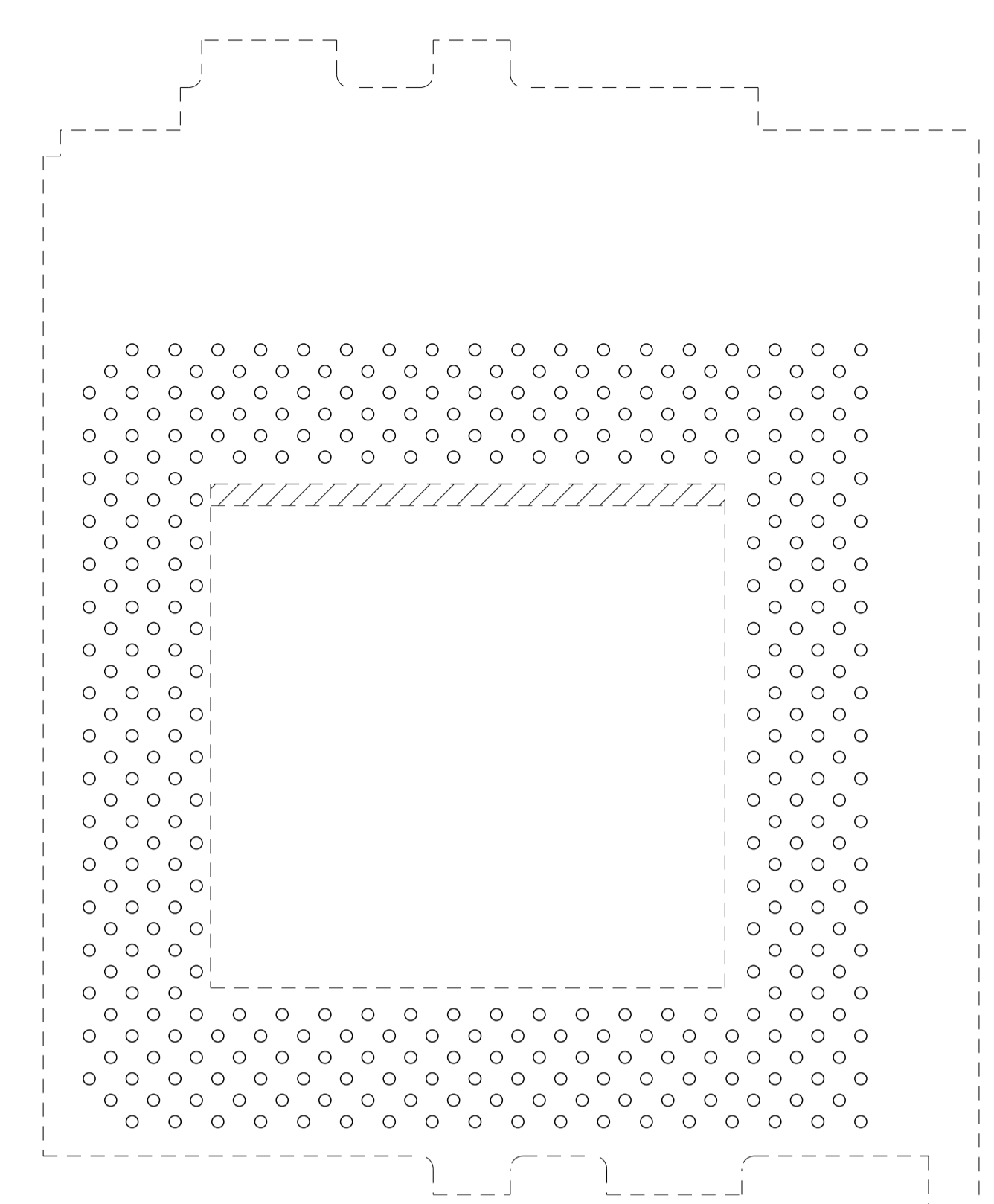
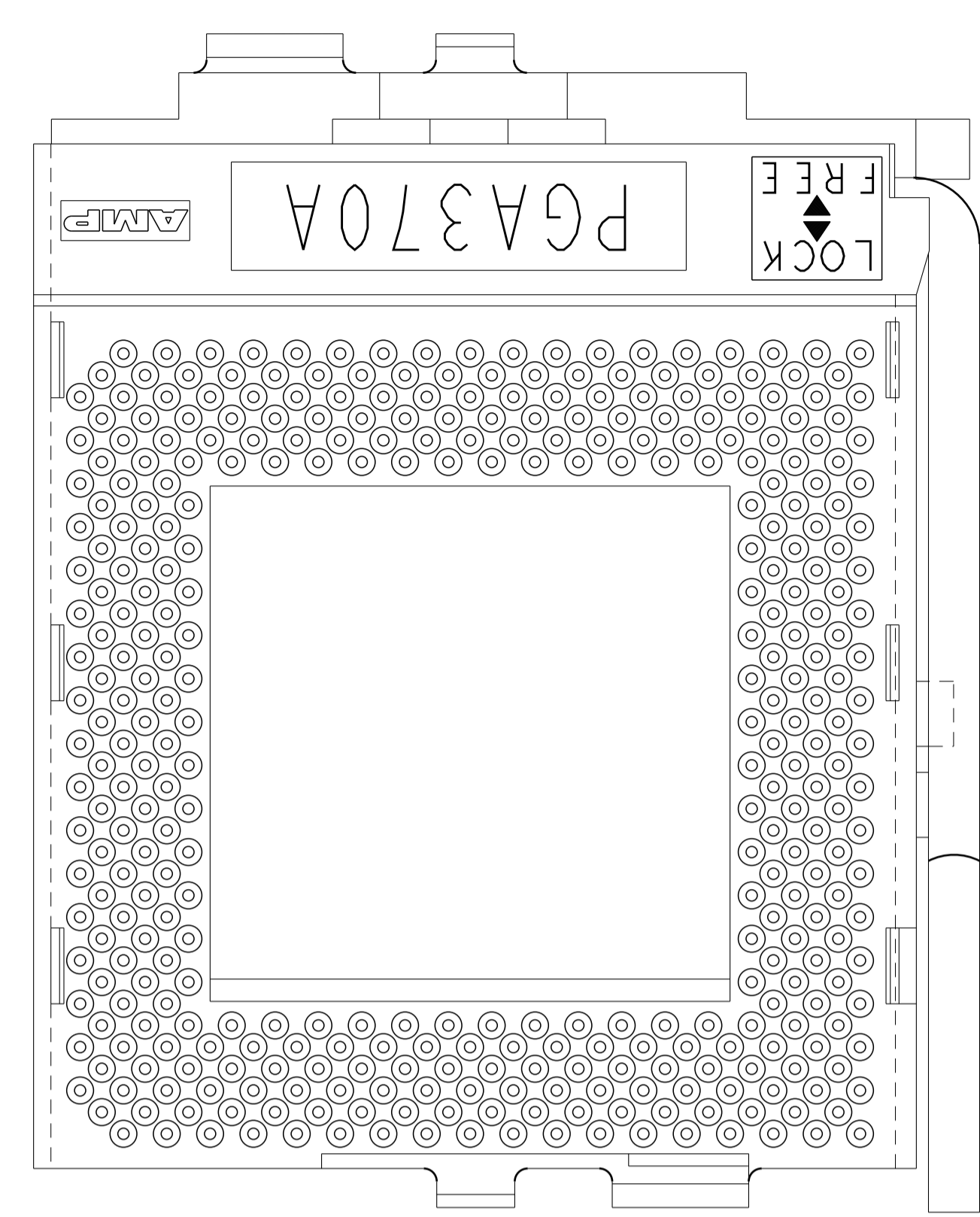

RECOMMENDED PCB HOLE LAYOUT  
 PART NUMBER 1-5916783-8  
 EXCEPT ROTATED PATTERN AND PGA370A LOGO, ALL OTHER DETAILS SAME AS ON SHEET 2.

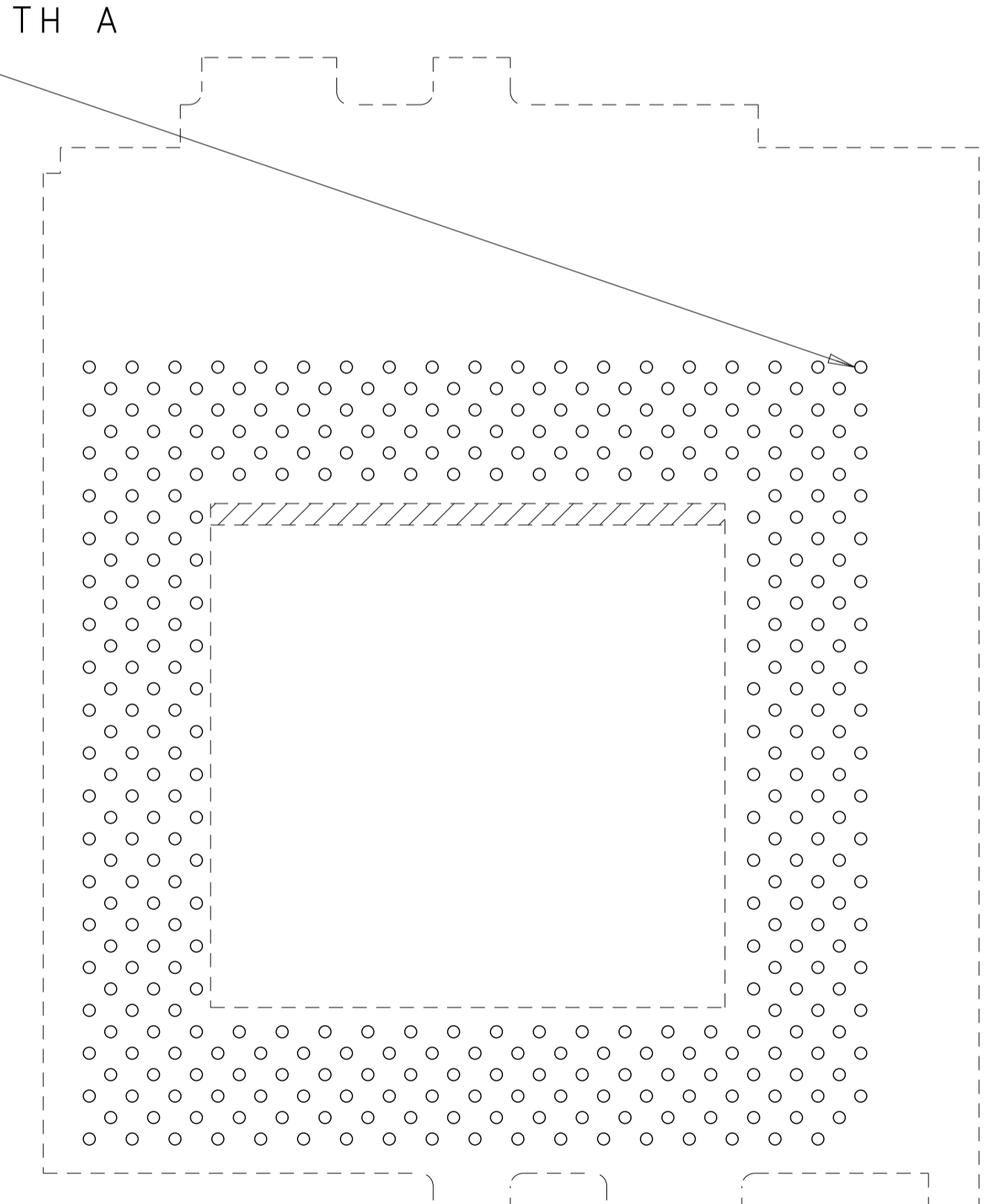
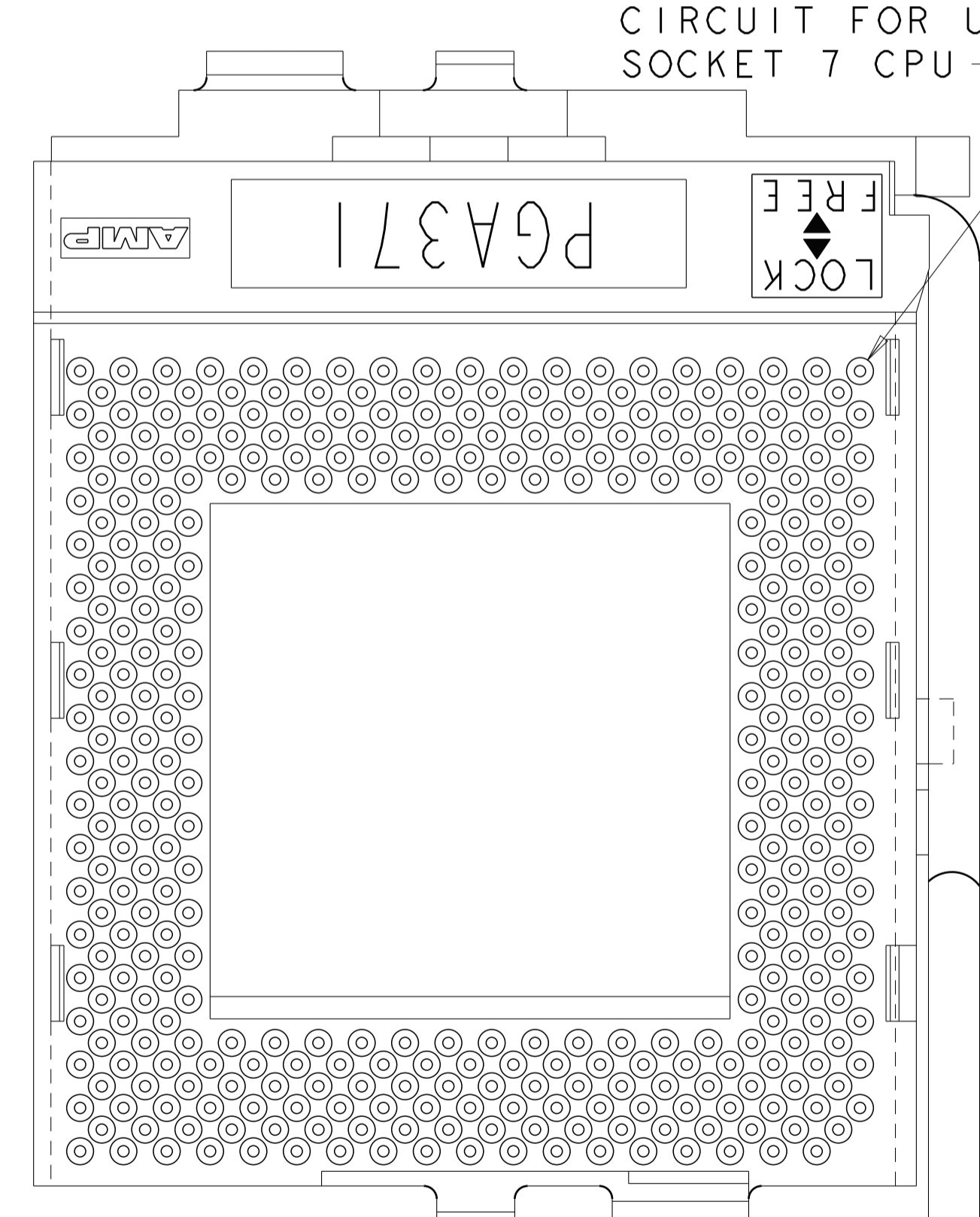

RECOMMENDED PCB HOLE LAYOUT  
 PART NUMBER 3-5916783-5, 371 POSITIONS  
 EXCEPT 371 POSITIONS PATTERN AND PGA371 LOGO, ALL OTHER DETAILS SAME AS ON SHEET 2.

<small>THIS DRAWING IS A CONTROLLED DOCUMENT FOR AMP INCORPORATED. ALL IS SUBJECT TO CHANGE. THE CONTROL AND REVISIONS ORGANIZATION SHOULD BE CONTACTED FOR THE LATEST REVISION.</small>		DWG NO: 15DEC2004 CHK: MYLEE CDR: VINCENT TAN	TE CONNECTIVITY Singapore
DIMENSIONS: mm [INCHES]		TOLERANCES UNLESS OTHERWISE SPECIFIED: 0 PLC ± 1 PLC ±.301 [.012] 2 PLC ± 3 PLC ± 4 PLC ± ANGLES ± FINISH	NAME: VINCENT TAN PRODUCT SPEC: SEE TABLE APPLICATION SPEC: SEE TABLE WEIGHT: - CUSTOMER DRAWING
MATERIAL:		SIZE: A1 CAGE CODE: 00779 DRAWING NO: 5916783	SCALE: 3:1 SHEET 3 of 6 REV PI

LOC	DIST	REVISIONS			
DATE	BY	DESCRIPTION	DATE	DWN	APPD
DY	-	SEE TABLE			

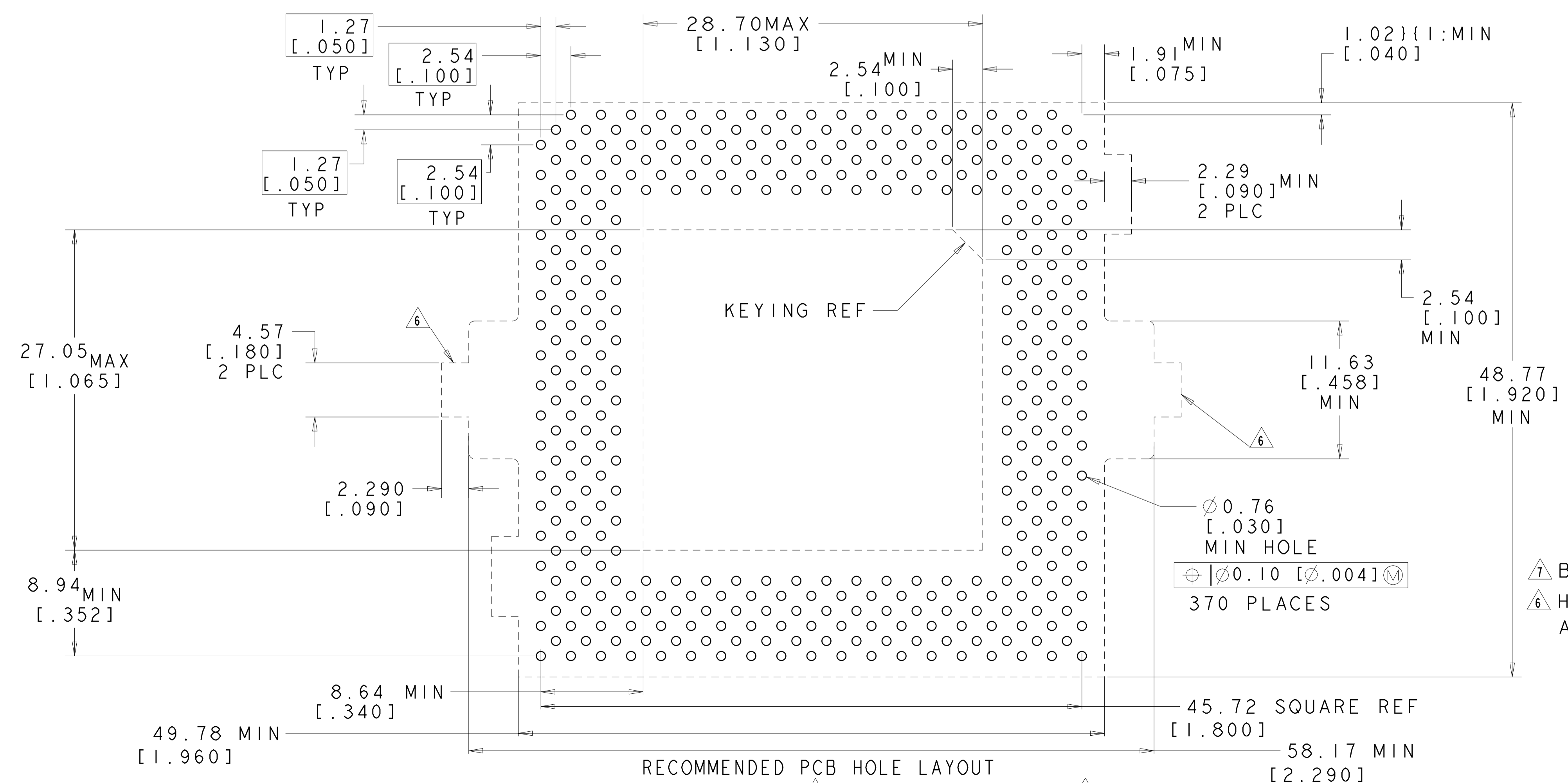
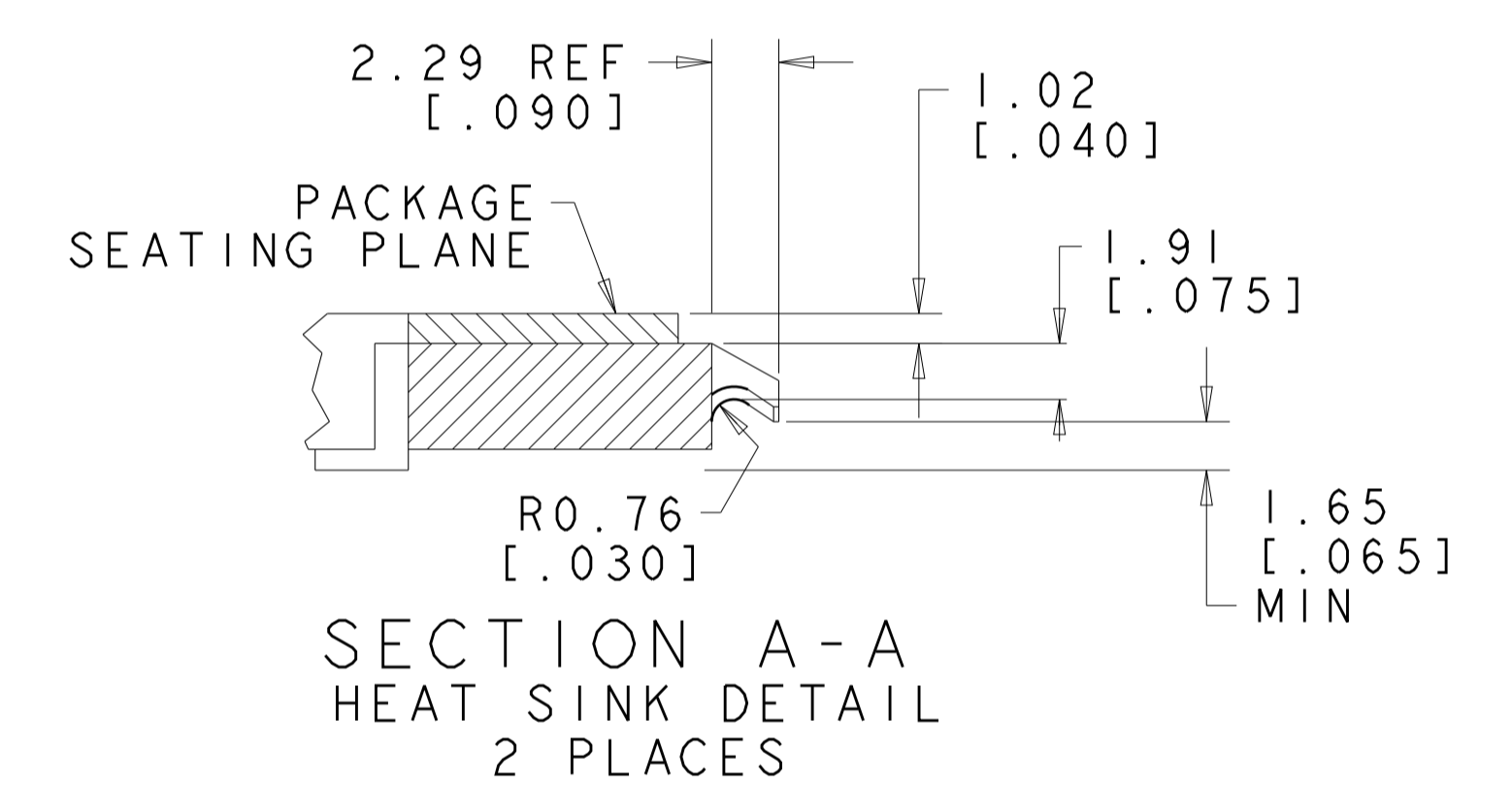
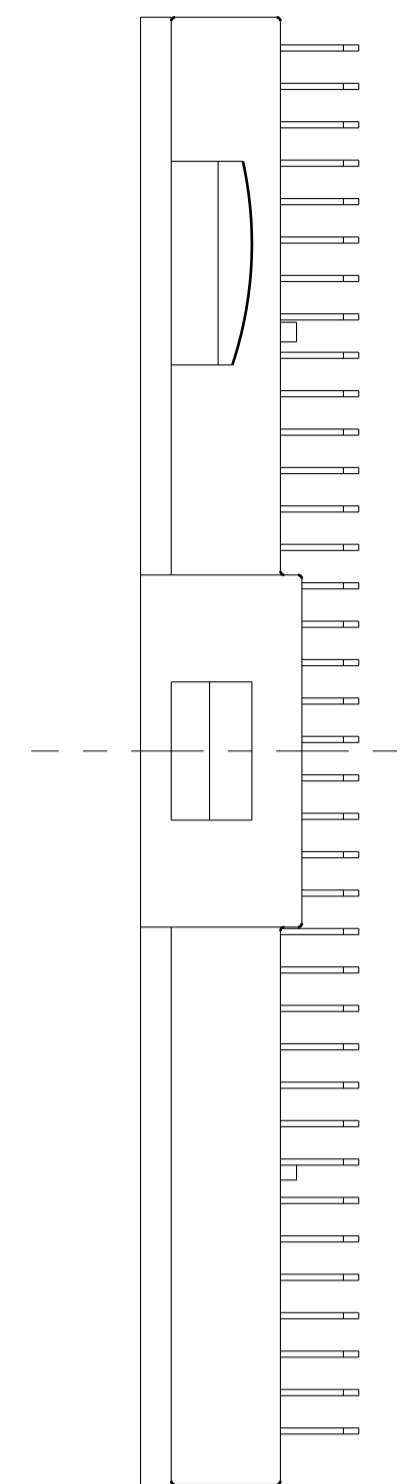
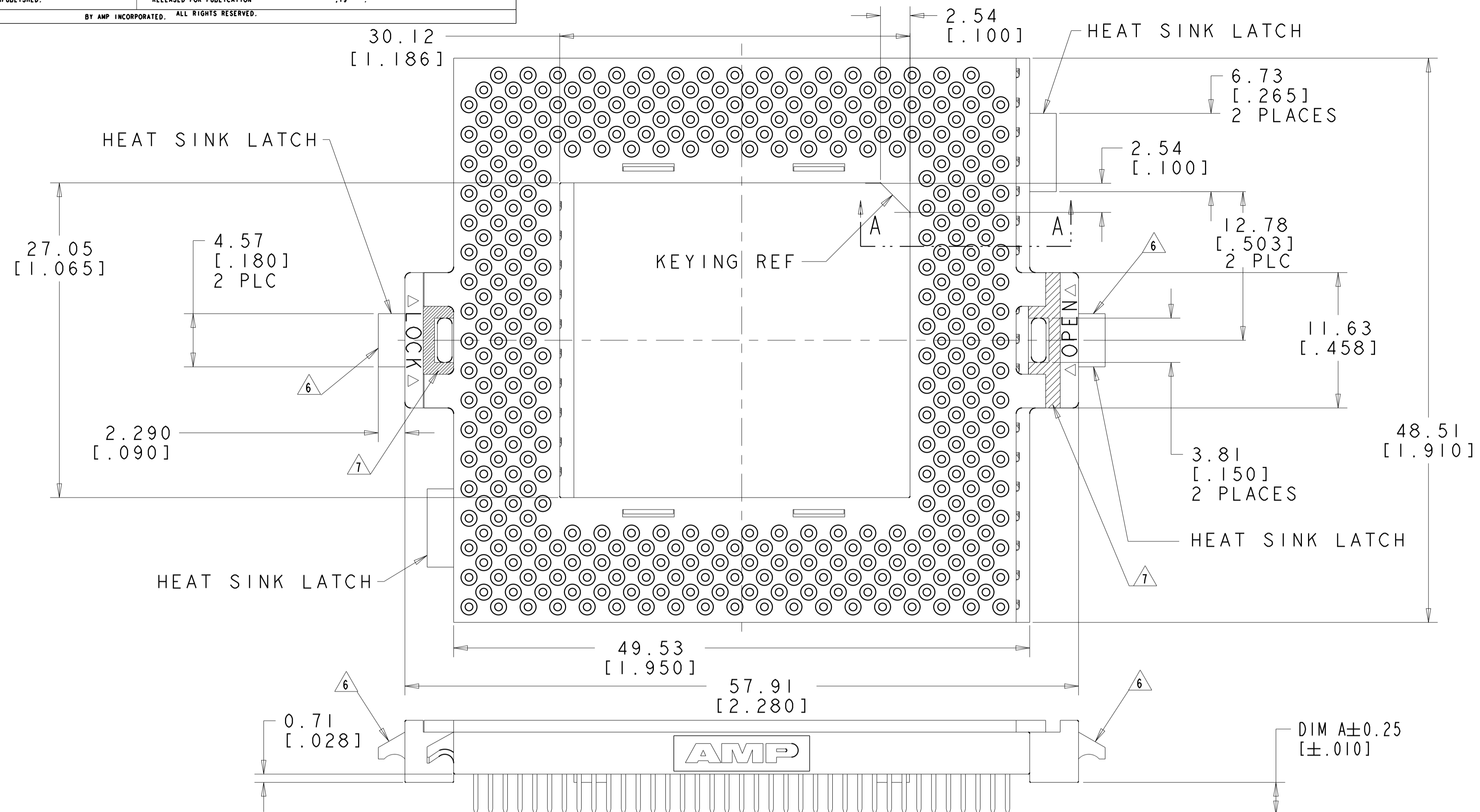

⚠ BLACK COLOUR MARKING ON HOUSING P/N: 4-5916783-7 ONLY.  
 ⚠ HEAT SINK LATCHES ON 4-5916783-5, 4-5916783-6 AND 4-5916783-7

PART NUMBERS 4-5916783-2, 4-5916783-5 AND 4-5916783-6 & 4-5916783-7

<small>THIS DRAWING IS A CONTROLLED DOCUMENT FOR AMP INCORPORATED. ALL INQUIRIES AND COMMENTS SHOULD BE CONTACTED FOR THE LATEST REVISION.</small>		DWN: WYLEE 15DEC2004 CHK: VINCENT TAN APD: SE LEONG PRODUCT SPEC: SEE TABLE APPLICATION SPEC: SEE TABLE	NAME: SOCKET ASSEMBLY, LOW PROFILE, ZIF PGA, 19 X 19 GRID SIZE: A1 CAGE CODE: 00779 DRAWING NO: 5916783 SCALE: 3:1
DIMENSIONS: mm [INCHES] 0 PLC ± 1 PLC ±.001 [0.012] 2 PLC ±.001 [0.012] 3 PLC ±.001 [0.012] 4 PLC ±.001 [0.012] ANGLES ±	TOLERANCES UNLESS OTHERWISE SPECIFIED: 0 PLC ± 1 PLC ±.001 [0.012] 2 PLC ±.001 [0.012] 3 PLC ±.001 [0.012] 4 PLC ±.001 [0.012] ANGLES ±	MATERIAL: FINISH:	CUSTOMER DRAWING DATE: 15DEC2004 SHEET 4 OF 6 REV PI

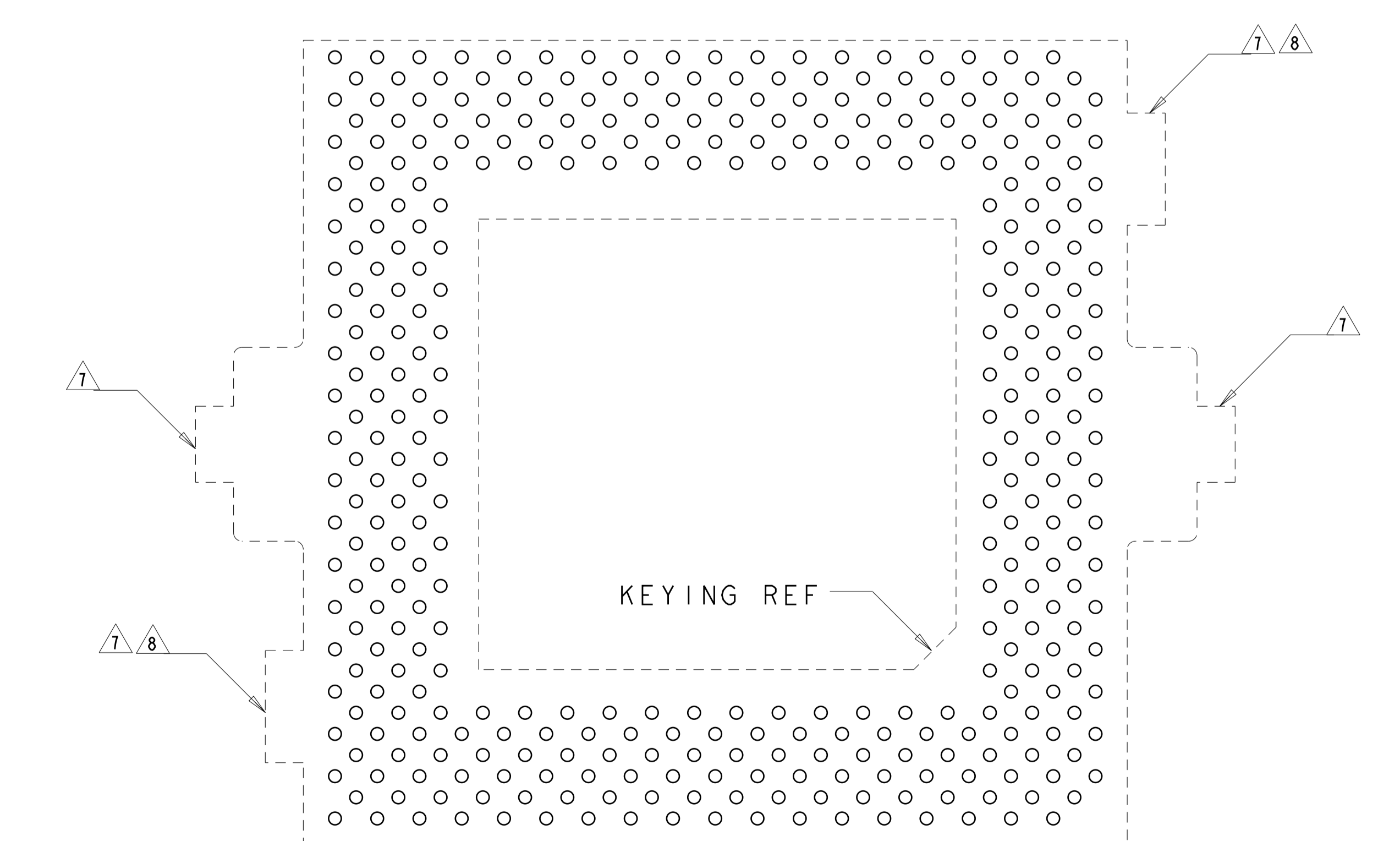
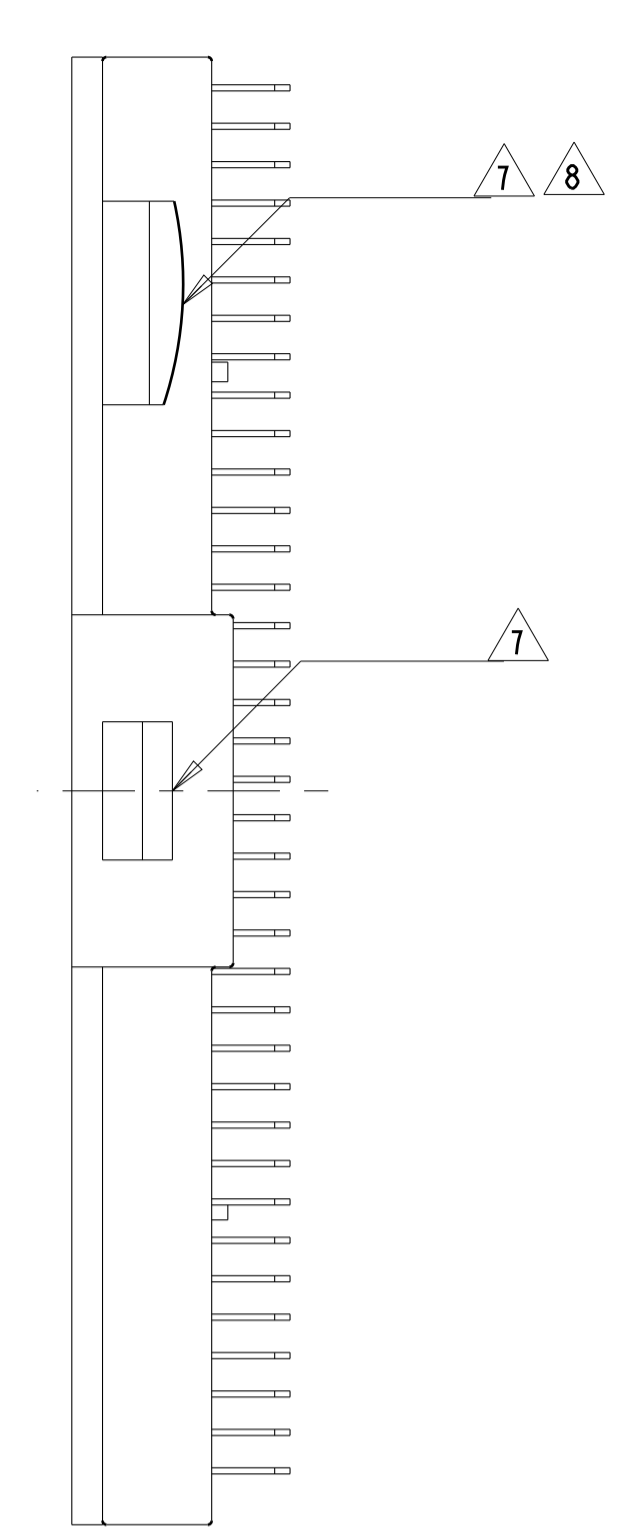
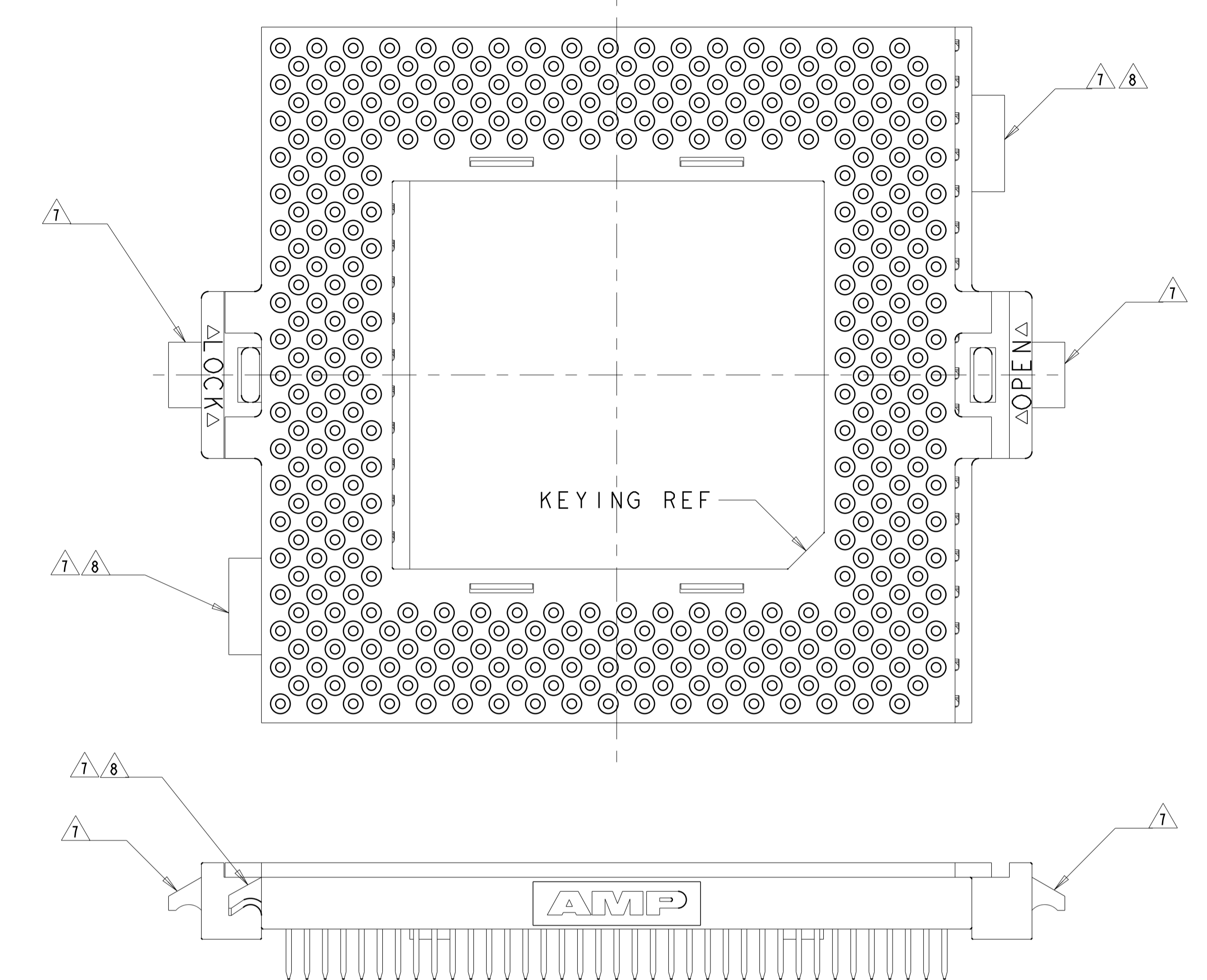

7 HEAT SINK LATCHES ON 5-5916783-5 ONLY.  
 8 HEAT SINK LATCHES ON 5-5916783-6 ONLY

RECOMMENDED PCB HOLE LAYOUT  
 PART NUMBERS 5-5916783-2, 5-5916783-5 AND 5-5916783-6  
 EXCEPT FOR PATTERN AND ROTATED KEYING  
 ALL OTHER DETAILS SAME AS SHEET 4

<small>THIS DRAWING IS A CONTROLLED DOCUMENT FOR AMP INCORPORATED. ALL ASPECTS OF THE DRAWING, INCLUDING THE CONTROLLING LINE NUMBER, ORGANIZATION SHOULD BE CONTACTED FOR THE LATEST REVISION.</small>		DWN: 15DEC2004 CHK: WYLEE APD: VINCENT TAN PRODUCT SPEC: SE LEONG APPLICATION SPEC: SEE TABLE WEIGHT: - FINISH: 2	TE CONNECTIVITY Singapore NAME: SOCKET ASSEMBLY, LOW PROFILE, ZIF PGA, 19 X 19 GRID SIZE: A1 CAGE CODE: 00779 DRAWING NO: 5916783
DIMENSIONS: mm [INCHES] 0 PLG ± 1 PLG ± 2 PLG ±0.301 (0.121) 3 PLG ± 4 PLG ± ANGLES ± FINISH: 1	TOLERANCES UNLESS OTHERWISE SPECIFIED: 0 PLG ± 1 PLG ± 2 PLG ±0.301 (0.121) 3 PLG ± 4 PLG ± ANGLES ± FINISH: 2	CUSTOMER DRAWING	SCALE: 3:1 SHEET: 5 of 6 REV: PI

LOC	DIST	REVISIONS			
DATE	BY	DESCRIPTION	DATE	DWN	APPD
19	DI	SEE TABLE			

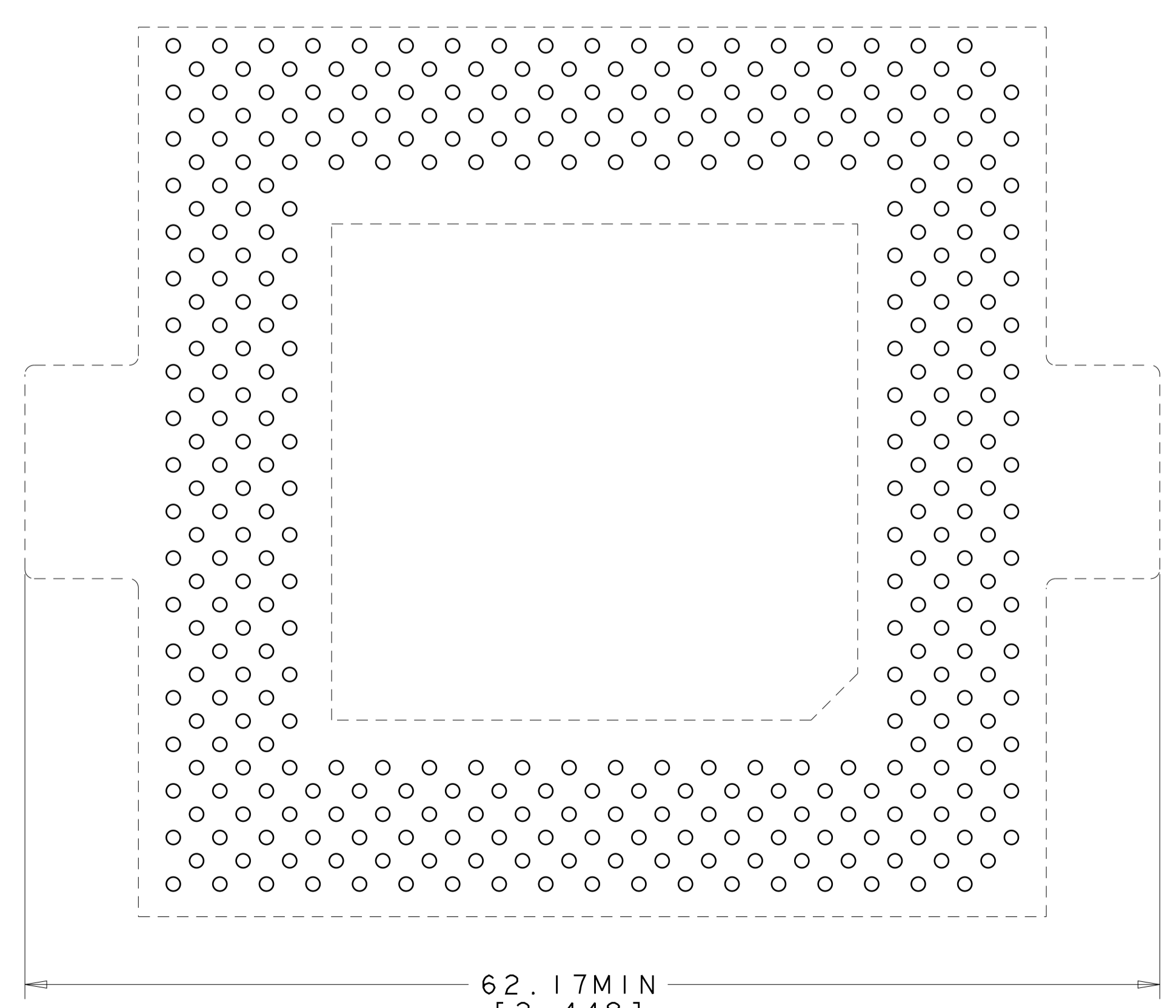
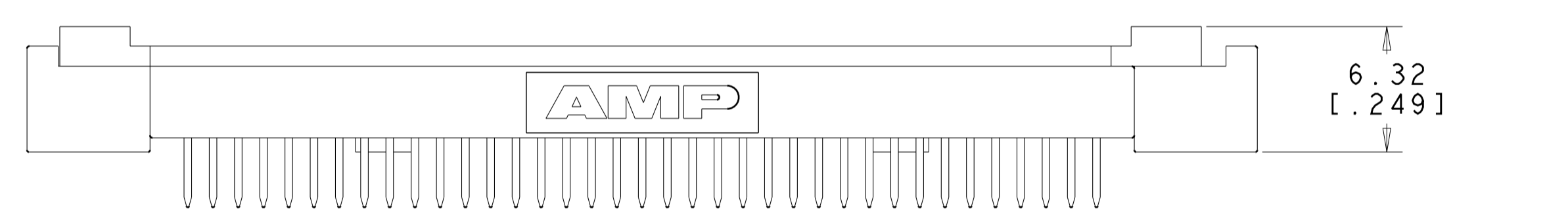
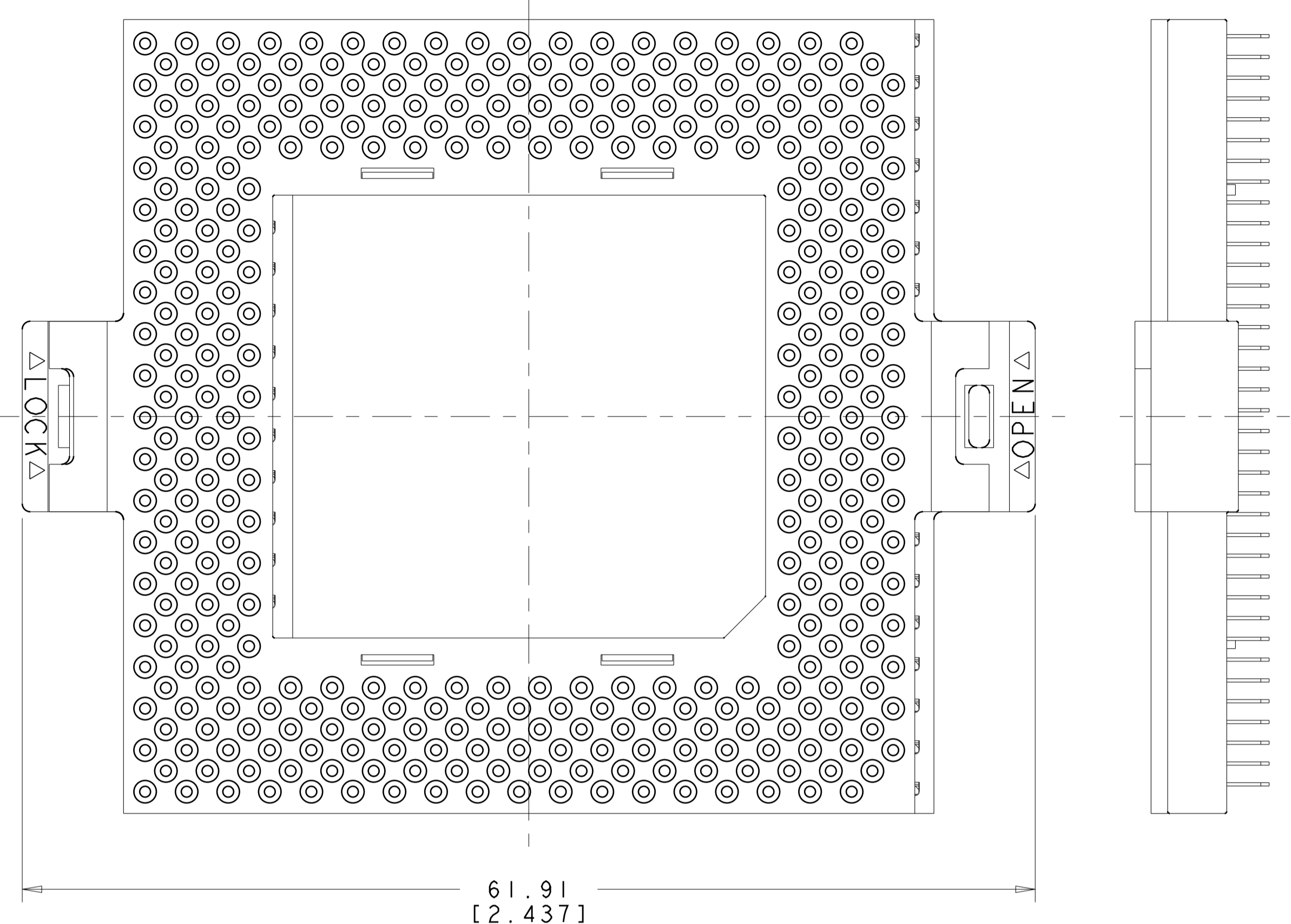

RECOMMENDED PCB HOLE LAYOUT  
 PART NUMBER 6-5916783-1  
 EXCEPT FOR PATTERN, ROTATED KEYING, NO HEAT SINK LATCHES AND EXTENDED ACTUATION TABS,  
 ALL OTHER DETAILS SAME AS 4-5916783-2

<small>THIS DRAWING IS A CONTROLLED DOCUMENT FOR AMP INCORPORATED. ALL ASPECTS OF THIS DRAWING ARE THE PROPERTY OF AMP INCORPORATED. ORGANIZATION SHOULD BE CONTACTED FOR THE LATEST REVISION.</small>		DWN: WYLEE CHK: VINCENT TAN APD: SE LEONG PRODUCT SPEC: SEE TABLE APPLICATION SPEC: SEE TABLE	DATE: 15DEC2004 NAME: SOCKET ASSEMBLY, LOW PROFILE, ZIF PGA, 19 X 19 GRID SIZE: A1 CAGE CODE: 00779 DRAWING NO: 5916783	TE CONNECTIVITY Singapore
DIMENSIONS: mm [INCHES]	TOLERANCES UNLESS OTHERWISE SPECIFIED: 0 PLC ± 1 PLC ± 2 PLC ±0.301 (012) 3 PLC ± 4 PLC ± ANGLES ± FINISH	MATERIAL:	WEIGHT: - SCALE: 3:1 SHEET: 6 of 6 REV: PI	CUSTOMER DRAWING