

ConstantColor™ CMH G8.5 and G12 Ultra

New Generation of Single Ended Ceramic Metal Halide Lamps
35W and 70W

DATA SHEET

Product information

GE's low watt CMH lamps have opened new possibilities for lighting design, combining the power and light quality of far larger and less efficient lamps. It is now possible to achieve lighting design that could not be achieved previously with inferior technologies.

GE's new ConstantColor™ CMH Ultra technology platform has been developed with specific focus to retail applications. GE Ultra technology offers superb overall light quality, outstanding lumen maintenance, improved efficacy, while maintaining long life and reliability. These qualities are why GE is the leader in ceramic metal halide technology.

- Premium CRI
- Drastically improved lumen maintenance
- Outstanding efficiency: 4x better than halogen
- Long life
- Robust and reliable performance
- Colour uniformity lamp to lamp
- Compact capsule

The next generation CMH lamps are the ultimate light source for retail applications where quality of light, colour and efficiency are important. Now, anyone with critical colour needs can enjoy the outstanding energy efficiency and the savings that CMH lamps provide. ConstantColor™ CMH Ultra lamps offer substantial benefits that make them the clear choice for specification into new stores, or into re-lamping existing store fixtures through regular replacement needs.

Single ended format

Single ended Ceramic Metal Halide lamps are made to provide symmetrical beam distribution using the axial configuration of the discharge arc. A variety of beam angles are possible and adjustable beam control can be built into the luminaire. This compact lamp shape enables luminaire size to be minimised and the bi-pin lamp base enables easy changing with front access.



Features

- More usable light over life, up to 33% more lumen output at end of life vs standard CMH lamps
- CMH Ultra lamps offer enhanced colour rendition vs standard 3000K CMH
- Extra long life of 16,500 hours for the 35W and 18,000 hours for the 70W
- Extended service life and relamp cycles
- Compatible with both electronic and magnetic HID ballasts
- 35W vertical ± 60 degrees, 70W universal burning position
- Same size as standard CMH G12, G8.5

Applications areas

Retail & accent lighting, office and hospital lighting

- General retail display
- Wherever current generation CMH 70W and CMH 35W products are in use.

New 35W and 70W Ultra retrofits directly into existing G8.5 and G12 fixtures, expands new sale offerings via improved lumen maintenance and colour rendering.



Specification summary

Ordering Information

Description	Wattage	Colour	Product Code
CMH35/TC/V60/UVC/930/G8.5 ULTRA	35	3000K	76120
CMH35/T/V60/UVC/930/G12 ULTRA	35	3000K	76121
CMH70/TC/UVC/U/930/G8.5 ULTRA	70	3000K	96751
CMH70/T/UVC/U/930/G12 ULTRA	70	3000K	96752
CMH70/T/UVC/U/930/G8.5 ULTRA WHITE	70	3000K	63595
CMH70/T/UVC/U/930/G12 ULTRA WHITE	70	3000K	63596

General	Units	35W ULTRA 930 G8.5	35W ULTRA 930 G12	70W ULTRA 930 G8.5	70W ULTRA 930 G12	70W ULTRA WHITE 930 G8.5	70W ULTRA WHITE 930 G12
Product code		76120	76121	96751	96752	63595	63596
Nominal Wattage	[W]	35	35	70	70	70	70
Nominal Colour Temperature		3000K	3000K	3000K	3000K	3000K	3000K
Format		Single ended	Single ended	Single ended	Single ended	Single ended	Single ended
Bulb Type		T4.5	T4.5	T4.5	T6	T4.5	T6
Bulb Diameter	[mm]	14.5	14.5	14.5	19	14.5	19
Bulb Material		UVC Quartz	UVC Quartz	UVC Quartz	UVC Quartz	UVC Quartz	UVC Quartz
Bulb Finish		Clear	Clear	Clear	Clear	Clear	Clear
Arc Gap	[mm]	4.5	4.5	6.0	6.0	6.0	6.0
Base		G8.5	G12	G8.5	G12	G8.5	G12

Operating Conditions

Burning Position	Vertical ±60°	Vertical ±60°	Universal	Universal	Universal	Universal
Luminaire Characteristics	Enclosed	Enclosed	Enclosed	Enclosed	Enclosed	Enclosed

Notes:

1) Note that the lamp voltage inside the luminaire should not deviate by more than 5V from the bare lamp voltage in free air. 2) Thermal protection required.

Electrical Characteristics

Lamp Power	[W]	39	39	72	72	74	74
Lamp Voltage	[V]	93	93	95	95	97	98
Lamp Current	[A]	0.42	0.42	0.93	0.93	0.94	0.93
Max. Ignition Voltage	[kV]	5.0	5.0	5.0	5.0	5.0	5.0
Min. Ignition Voltage	[kV]	3.0	3.0	3.0	3.0	3.0	3.0
Extinction Voltage (% of Rated Input Voltage)	[%]	90 (Max)	90 (Max)	90 (Max)	90 (Max)	90 (Max)	90 (Max)

The specification provides typical performance data for 70W operating from a 50Hz mains sinewave supply at rated power, and for 35W operating on most electronic ballasts. Actual values depend on ballast, supply voltage and application. ConstantColor CMH Ultra lamps are compatible with a list of approved electronic ballasts, and conventional 50Hz 230V magnetic choke ballasts. Contact your GE representative for more information.

Photometric Characteristics*

100 hrs Lumens	[lm]	3,600	3,600	6,200	6,400	6,700	6,600
Typical Lumen Change with Burning Position – Vertical to Horizontal	[lm]	150	150	125	125	125	125
Typical voltage change with burning position – Vertical to Horizontal	[V]	8	8	8	8	8	8
Chromaticity X		0.438	0.438	0.443	0.443	0.436	0.440
Chromaticity Y		0.396	0.396	0.405	0.405	0.400	0.400
Colour Rendering Index	[Ra]	87	87	88	87	88	88
Luminous Efficacy	[lm/W]	92	92	86	89	91	89

*Photometric characteristics refer to lamp performance after 100 hours burning in vertical position. 35W may be operated vertical+/-60 degrees. Horizontal change is indicative.

Starting and Warm-up Characteristics*

Time to Start (at 25 °C)	[sec.]	< 2	< 2	< 2	< 2	< 2	< 2
Time to Start – Cold Box Test at -30 °C	[sec.]	< 15	< 15	< 15	< 15	< 15	< 15
Hot Restart Time	[min.]	< 8	< 8	< 15	< 15	< 15	< 15
Warm-up Time (for 90% Lumens)	[min.]	< 2	< 2	< 3	< 3	< 3	< 3

* Typical values (actual values are ballast and ignitor dependent).

Through life Performance

Lumen Maintenance at 40% Rated Life (Mean Lumens)	[%]	85	85	83	83	83	83
Average Rated Life	[h]	16,500 (ECG)/ 10,000 (EM)	16,500 (ECG)/ 10,000 (EM)	18,000	18,000	18,000	18,000

Maximum Operating temperatures*

Maximum Allowed Bulb Temperature (Horizontal Orientation, Thermocouple Attached Above Burner)	[°C]	500	500	550	500	550	500
Maximum Pinch Temperature (Vertical Base up Orientation)	[°C]	300	350	300	350	300	350

* Temperatures above which lamp performance or reliability is impaired.

Dimensions

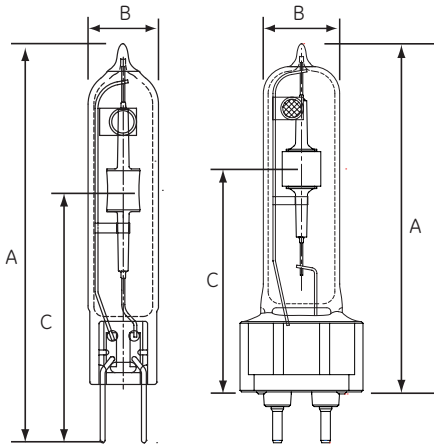

	35W G8.5	70W G8.5	35W G12	70W G12
A [mm] max.	85	85	90	90
B [mm] nominal	14.5	14.5	14.5	19
C [mm] nominal	52	52	56	56

Spectral power distribution

Representative Spectral power distribution curves are provided in the following diagrams.

CMH Ultra 35W 930

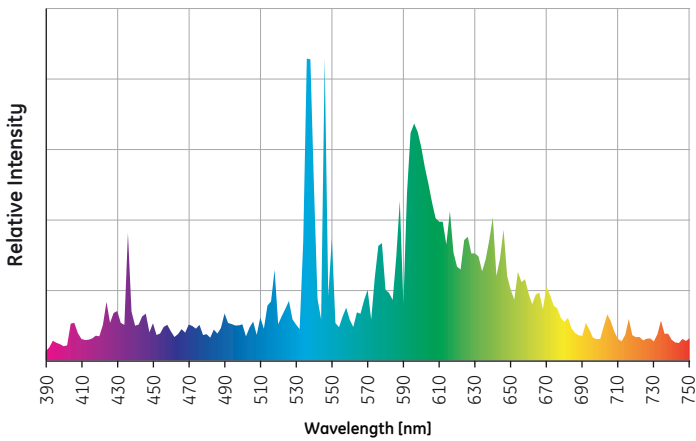

CMH Ultra 70W 930

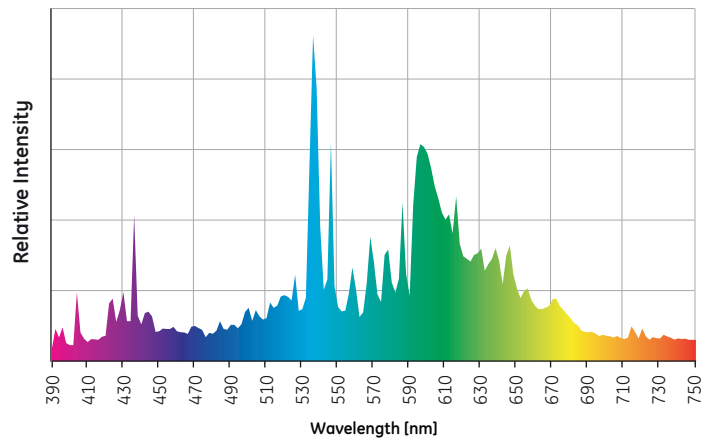

Distribution of luminous intensity

The following diagrams show typical polar light intensity curves of the lamps in vertical base-up position

Horizontal plane polar intensity curve

CMH Ultra 35W V60 930 G8.5

$I_{max} = 355\text{cd}$

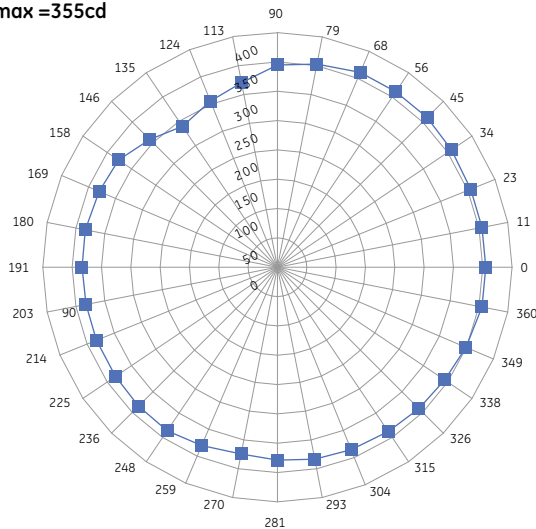

Vertical plane polar intensity curve

CMH Ultra 35W V60 930 G8.5

$I_{max} = 355\text{cd}$

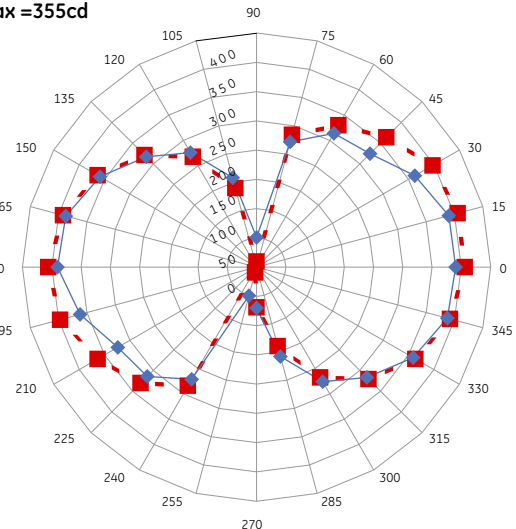

CMH Ultra 70W U930 G8.5

Imax=647cd

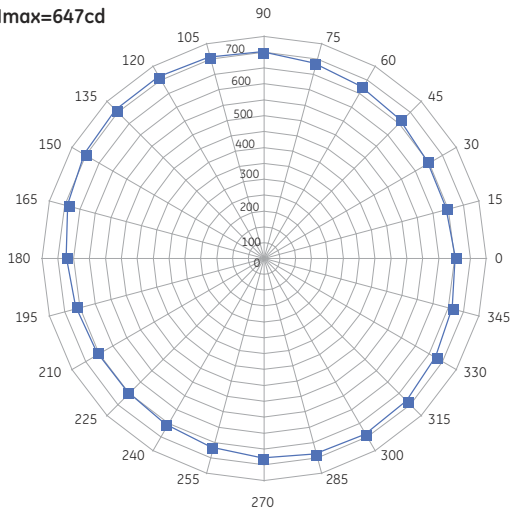

CMH Ultra 70W U930 G8.5

Imax=647cd

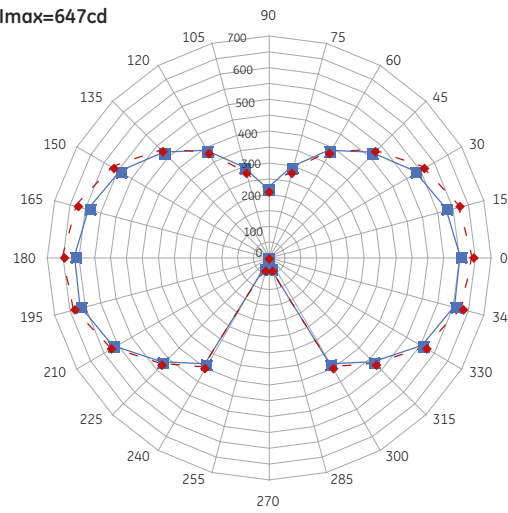

CMH Ultra 70W U930 G12

Imax=654cd

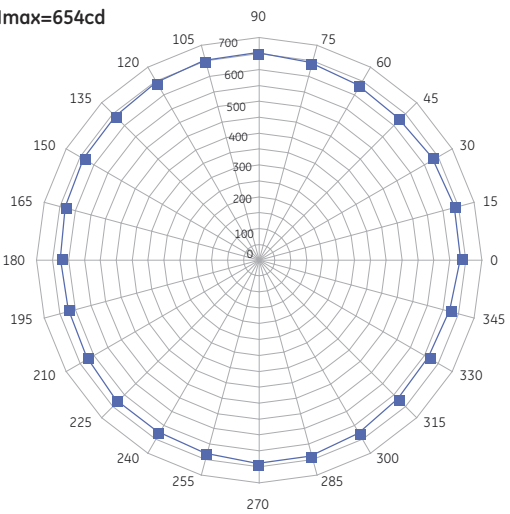

CMH Ultra 70W U930 G12

Imax=654cd

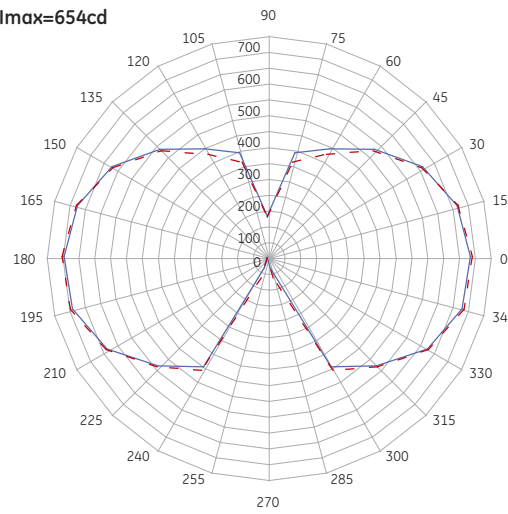

Lamp life

Life survival graphs are shown for statistically representative batches of lamps operated under controlled nominal conditions with an 11 hours per start switching cycle. The declared lamp life is the median life, which is when 50% of the lamps from a large sample batch would have failed. Lamp life in service will be affected by a number of parameters, such as supply voltage variation, switching cycle, operating position, mechanical vibration, luminaire design and control gear. The information is intended to be a practical guide for comparison with other lamp types. The determination of lamp replacement schedules will depend upon the acceptable reduction in illuminance and the relative costs of spot and group replacement.

Note: The representative curves are taken in Vertical Base Up position.

CMH 35W Ultra 930 ECG

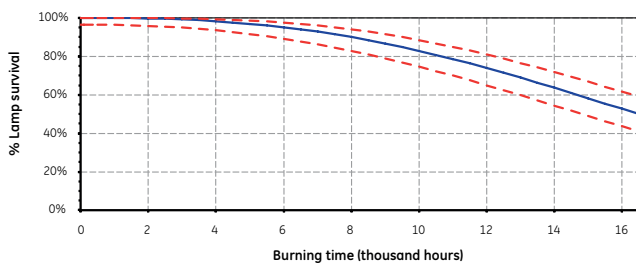

CMH 35W Ultra 930 EM

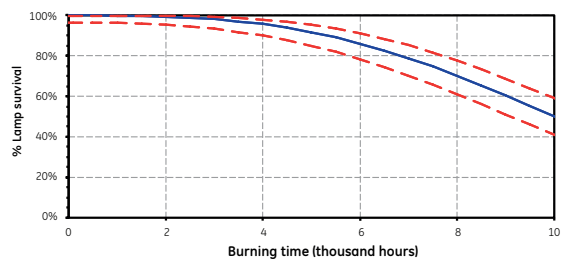

CMH 70W Ultra 930

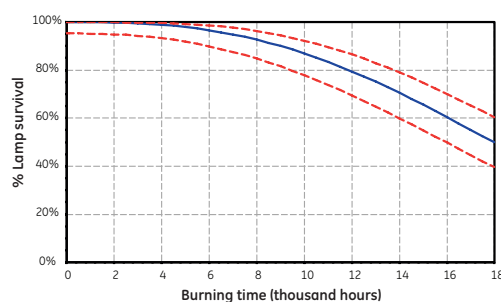

Lumen maintenance

The lumen maintenance graph shows light output performance through life for statistically representative batches of lamps operated under controlled conditions with an 11 hours per start switching cycle. A common characteristic for all metal halide lamps is a reduction in light output and a slight increase in power consumption through life. Consequently there is an economic life at which lamp efficacy falls to a level when lamps should be replaced to restore design illumination levels. In areas where multiple lamps are installed, consideration should be given to a group lamp replacement programme to maintain uniform illumination levels. Curves represent operating conditions for an 11 hours per start switching cycle, but less frequent switching will improve lumen maintenance.

Note: The representative curves are taken in Vertical Base Up position.

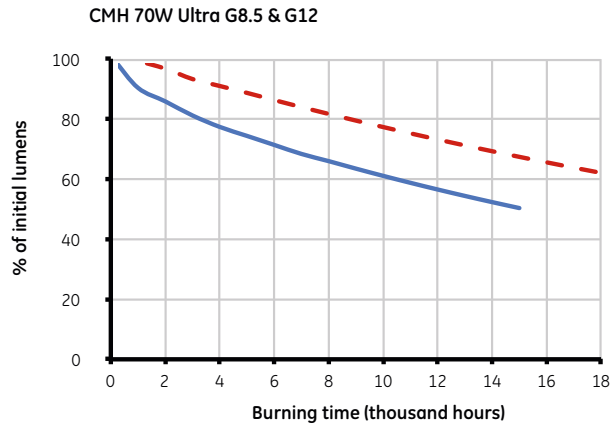
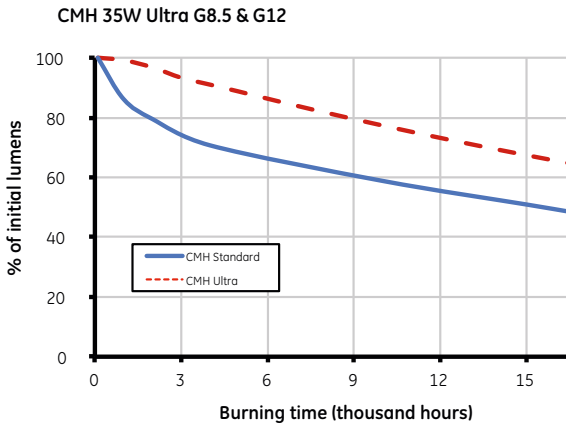

Warm-up characteristics

During the warm-up period immediately after starting, lamp temperature increases rapidly and mercury and the metal halides evaporate within the arc-tube. The lamp current and voltage will stabilise in less than 4 minutes. During this period the light output will increase from zero and the colour will approach the final visual effect as each metallic element becomes vaporised.

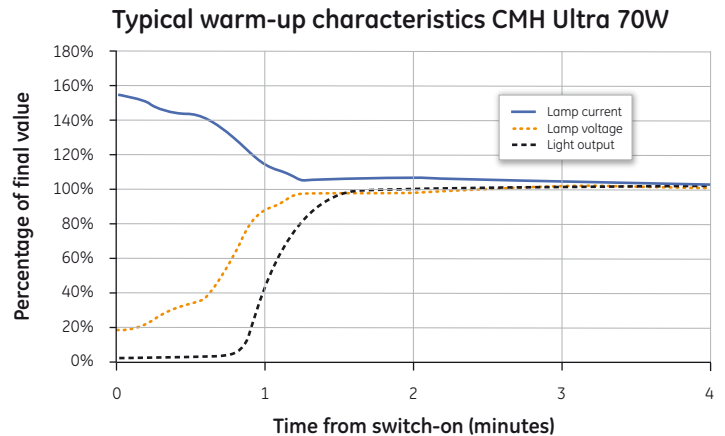
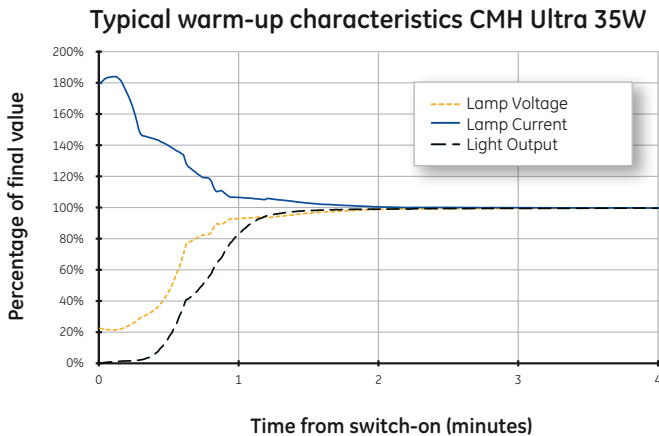

Supply voltage sensitivity

The line supply voltage applied to the control gear should be as close to rated nominal as possible. Lamps will start and operate at 10% below rated supply voltage but this should not be considered as a normal operating condition. In order to maximise lamp survival, lumen maintenance and colour uniformity, supply voltage and rated ballast voltage should be within $\pm 3\%$. Supply variations of $\pm 5\%$ are permissible for short periods only. Where supply voltage variation is likely to occur the use of electronic control gear should be considered as this type of equipment is normally designed to function correctly for a voltage range of 200-240V.

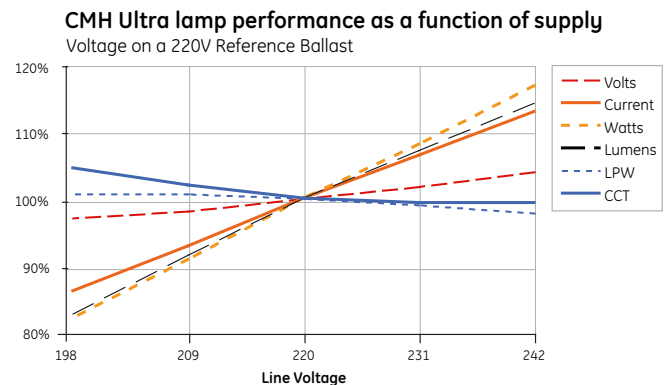

Dimming

In certain cases, dimming may be acceptable, subject to further testing. Contact your GE representative for more information. Large changes in lamp power alter the thermal characteristics of the lamp resulting in lamp colour shift and possible reduction in lamp survival.

Flicker

When ConstantColor™ CMH lamps are operated from a conventional magnetic ballast there will be 50Hz line frequency light output flicker, typically of 1.5%, in common with all other discharge lamps. Noticeably lower flicker levels occur when lamps are operated horizontally. Flicker levels of 1.5% do not normally cause concern to the end user, but use of electronic control gear should be considered where visual comfort and performance is critical. Suitable electronic ballast for ConstantColor™ CMH typically provide square wave operation in the range 70-400Hz, eliminating perceptible flicker.

End-of-life conditions

The principal end-of-life failure mechanism for CMH lamps is arc tube leakage into the outer jacket. High operating temperature inside the arc tube causes metal halide dose material to gradually corrode through the ceramic arc tube wall, eventually resulting at normal end-of-life in leakage of the filling gas and dose. Arc tube leakage into the outer jacket can be observed by a sudden and significant lumen drop and a perceptible colour change (usually towards green). The above situation is often accompanied by the so-called rectification phenomena. This occurs where a discharge is established between two mount-frame parts of different material and/or mass, causing asymmetry in the electrical characteristic of the resulting discharge current. Rectification can lead to overheating of the ballast, therefore conventional magnetic ballasts must conform to requirements of the IEC61167 lamp standard by incorporating protection to maintain safety and prevent damage.

End-of-life cycling

A condition can exist at end-of-life whereby lamp voltage rises to a value exceeding the voltage supplied by the control gear. In such a case the lamp extinguished and on cooling restarts when the required ignition voltage falls to the actual pulse voltage provided by the ignitor. During subsequent warm-up the lamp voltage will again increase, causing extinction. This condition is known as end-of-life cycling. Normally cycling is an indication that lamp end-of-life has been reached, but it can also occur when lamps are operated above their recommended temperature. Lamp voltage at 100 hours life should not increase by more than 5V when operating in the luminaire, when compared to the same lamp operating in free-air. A good luminaire design will limit lamp voltage rise to 3V.

It is good practice to replace lamps that have reached end-of-life as soon as possible after failure, to minimise electrical and thermal stress on ignitor components. The use of a 'timed' or 'cut-out' ignitor is not a specific requirement for ConstantColor™ CMH lamps, but is worth considering as a good optional safety feature which also prolongs the life of ignitor internal components, lamp holder contact surfaces, and fixture wiring.

The operating period of a timed/cut-out ignitor must be adequate to allow lamps to cool and restart. A period of 10 to 15 minutes continuous or intermittent operation is recommended before the ignitor automatically switches off. Timed/cut-out ignitors, specifically offered for High-Pressure Sodium lamps, where the period of operation is less than 5 minutes, are not suitable for ConstantColor™ CMH lamps.

UV and damage to sensitive materials

The wall of the bulb, which is produced with specially developed 'UV Control' material, absorbs potentially harmful high energy UV radiation emitted by the ceramic arc tube.

The use of UV control material together with an optically neutral front glass cover allows the lamp to significantly reduce the risk of discolouration or fading of products. When illuminating light-sensitive materials or at high light levels, additional UV filtration is recommended. Luminaires should not be used if the front glass is broken or missing. It is recommended that a safety interlock switch is incorporated into the luminaire to prevent operation when the luminaire is opened.

Although PET determines limits of human exposure to lamp UV, the risk of fading of materials due to UV can be quantified by a damage factor and a risk of fading. The risk of fading is simply the numerical product of the illuminance, exposure time and damage factor due to the light source.

Finally the selection of luminaire materials should take into consideration the UV emission. Current UV reduction types on the market are optimised for UV safety of human eye and skin exposure. However, luminaire materials may have different wavelength dependent response functions. Designers must take account of emission in each of the UV-A, UV-B and UV-C spectral ranges as well as material temperatures when designing luminaires.

Typical values for UV-A, UV-B and UV-C range radiation can be found in the table below.

Lamp type		35W Ultra 930 G8.5 & G12	70W Ultra 930 G8.5	70W Ultra 930 G12	70W Ultra White 930 G8.5	70W Ultra White 930 G12
UV-PET performance						
UV-C ¹	220-280nm	0.0165	0.0161	0.0149	0.0160	0.0130
UV-B ¹	280-315nm	0.0250	0.0205	0.0219	0.0220	0.0175
UV-A ¹	315-400nm	5.813	3.638	5.575	5.537	5.098
UVC/UVB		0.662	0.785	0.682	0.722	0.707
UVB/UVA		0.004	0.006	0.004	0.004	0.003
E_{eff}^2		0.503	0.492	0.472	0.494	0.393
PET (h)±10%		33	34	36	36	53
Risk group		Exempt	Exempt	Exempt	Exempt	Exempt

¹ $\mu\text{W}/(\text{cm}^2)/500 \text{ Lux}$
² mW/klm

Information on luminaire design

Ballasts

ConstantColor™ CMH lamps operate from the same type of ballast as conventional quartz technology metal halide lamps of the same nominal power. IEC 61167 MH lamp standard and IEC 62035 HID lamp safety standard specify use of ballast thermal protection or equivalent protection device in the circuit. This safety device will protect the ballast and fixture from overheating damage at lamp end-of-life should rectification occur due to electrode imbalance or arc tube failure. The IEC61167 requirement applies to both ceramic and quartz arc tube metal halide lamps of the UV-A, UV-B, and UV-C spectral ranges as well as material temperatures when designing luminaires. ConstantColor™ CMH lamps are compatible with a list of approved ballasts; contact your GE representative for more information.

Stray magnetic field of conventional ballast

At the design stage for fixtures incorporating the control gear, careful consideration should be given to the physical layout of the lamp and ballast. The relative positions and distance between lamp and ballast can adversely affect lamp performance and drastically reduce lamp survival.

Conventional magnetic ballasts can produce a stray magnetic field and if the lamp is placed within this field, “bowing” of the arc in the discharge tube can occur. Since ceramic is a very rigid material, severe arc bowing can cause high thermal stress leading to cracking or rupture of the arc tube, resulting in failure of the lamp early in life.

Such bowing of the arc can also affect the quartz arc tube in conventional metal halide lamps, but cracking or rupture failure is less likely since quartz softens at the resulting higher wall temperature causing the arc tube to become swollen. Excessive swelling of a quartz arc tube can however also result in cracking or rupture failure.

In fixtures where the ballast is necessarily placed close to the lamp, use of magnetic shielding is essential. Another solution is to use an electronic ballast, which eliminates the need for an ignitor, simplifies wiring, reduces the risk of stray magnetic field, and eliminates light output flicker.

Containment requirement

ConstantColor™ CMH lamps operate above atmospheric pressure, therefore a very small risk exists that the lamp may shatter when the end of life is reached. Though this failure mode is unlikely, containment of shattered particles is required as prescribed by IEC 62035.

Single-ended lamp should only be used in a suitable enclosed luminaire with front cover glass capable of containing the fragments of a lamp should it shatter.

Control gear and accessories

Electronic ballasts

A range of GE electronic ballasts have been introduced to complement the ConstantColor™ Ceramic Metal Halide lamps. Power controlled electronic ballasts suitable for operation of Ceramic Metal Halide lamps are available from various gear manufacturers.

Advantages are:

- Good regulation against supply voltage variation
- Improved lamp colour consistency
- Elimination of lamp flicker
- Reduced weight of control gear
- Reduced electrical power losses
- Ballast noise reduced/eliminated
- Single piece compact unit
- Reduced wiring complexity in the luminaire



Wiring between ignitor and lamp should have a maximum capacitance to earth of 100pF (length equivalent to less than 1 metre) – contact ignitor manufacturer for details of specific ignitor types. A typical circuit diagram is shown.

Typical superimposed ignitor circuit

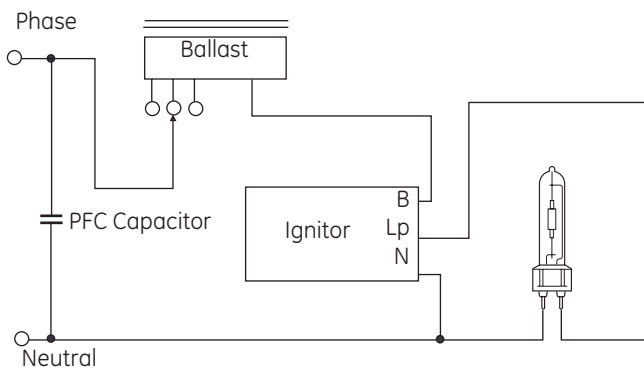

Suitable ignitors

Suitable high-energy (superimposed) ignitors are listed below recommended by gear manufacturers. Check with your supplier for their current range of ignitors. Lamp re-starting under warm lamp conditions can take up to 15 minutes. Suitable ignitors with a warm restart of less than 15 minutes include the following, however the list may not be fully inclusive.

Maker	Products				
APF	SP23				
BAG Turgi	NI 150 SE	NI 150 SE-TM20	MZN 150 SE-C	Ni 400 LE/3.5 A	NI 400 LE/3.5 A-TM20
ERC	AZ A 1.8	AZ P 1.8	AZ P 3.0	AZ P 1.8 T3	AZ P 3.0 T3
Helvar	L-150	LSI-150T20			
Optima	ZG 0.5	ZG 2.0	ZG 2.0 D	ZG 4.5 D	
Parmar	PAV400	PCX400	PXE100		
Philips	SU20S				
Thorn	G53459	G53498	G53476	G53504.TB	
Tridonic	ZRM 1.8-ES/B	ZRM 2.5-ES/B	ZRM 4.5-ES/B	ZRM 6-ES/B	ZRM 2.5-ES/D
Vossloh-Schwabe	Z 150	Z 150 K	Z 150 A10	Z 150 A10	Z 250

Impulser ignitors

Impulser type ignitors use the ballast winding as a pulse transformer and can only be used with a matched ballast. Always check with the ballast and ignitor supplier that components are compatible. Longer cable lengths between ballast and ignitor and the lamp are possible due to the lower pulse frequency generated, giving greater flexibility for remote control gear applications. Ignitor pulse characteristics at the lamp must however comply with specified minimum values for ConstantColor™ CMH lamps under all conditions.

Typical impulser ignitor circuit

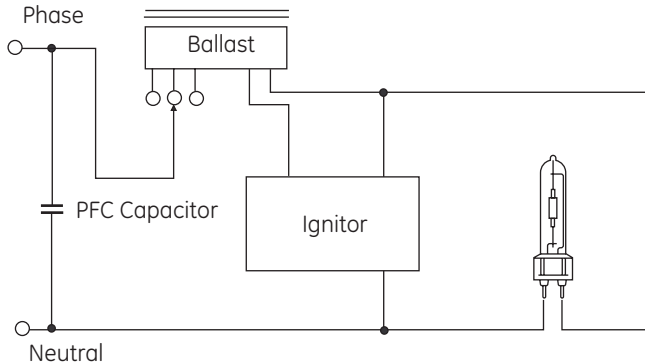

Other ignitor related considerations

Timed or cut-out ignitors

The use of a 'timed' or 'cut-out' ignitor is not a specific requirement for ConstantColor™ CMH lamps but it is a good optional safety feature worth considering to protect the ignitor from overheating and to prolong its life. If used, the timed period must be adequate to allow lamps to cool and restart as described in the previous section. A period of 10-15 minutes continuous or intermittent operation is recommended before the ignitor automatically switches off. Timed ignitors specifically offered for High-Pressure Sodium lamps where the period of operation is only about 5 minutes are not suitable for ConstantColor™ CMH lamps.

Hot re-strike

All ratings re-strike within 15 minutes following a short interruption in the supply. Actual re-strike time is determined by the ignitor type, pulse voltage and cooling rate of the lamp. Instant hot re-strike is only possible using a suitable very high voltage ignitor and a double ended lamp. GE Lighting should be consulted when considering use of an instant hot re-striking system.

Warm re-starting

The combined characteristics of ceramic arc tube material and vacuum outer jacket result in ConstantColor™ CMH lamps cooling relatively slowly. It is possible with low energy ignitors to reach the required breakdown voltage but not create a full thermionic discharge. Under these conditions the lamp can remain very warm and be prevented from cooling to a temperature at which the arc can be re-established. To avoid this, turn off the power supply for approximately fifteen minutes or change to a suitable high energy ignitor from the list given in the superimposed ignitor section.

Fusing recommendations

For a very short period immediately after switch-on, all discharge lamps can act as a partial rectifier and a conventional magnetic ballast may allow higher than the normal current to flow. At switch-on the short duration surge current drawn by the power factor correction capacitor can be high. In order to prevent nuisance fuse failure at initial switch-on, the fuse rating must take these transient conditions into account. A separate technical data sheet providing additional explanation and information for the fusing of High Intensity Discharge lighting circuits is available from GE Lighting. Fusing of individual fixtures is recommended, in order to provide added protection for end-of-life conditions when lamp rectification can also occur.

Number of Lamps	1	2	3	4	5	6
35W Fuse Rating (A)	4	4	4	4	4	6
70W Fuse Rating (A)	4	4	4	6	10	10

Safety warnings

The use of these products requires awareness of the following safety issues:

Warning

- Risk of electric shock - isolate from power supply before changing lamp
- Strong magnetic fields may impair lamp performance, and in the worst case could lead to lamp shattering.

Use in enclosed fixtures to avoid the following:

- Risk of fire
- A damaged lamp emits UV radiation which may cause eye/skin injury
- Unexpected lamp shattering may cause injury, fire or property damage

Caution

- Risk of burn when handling hot lamp
- Lamp may shatter and cause injury if broken
- Arc tube fill gas contains Kr-85

Always follow the supplied lamp operation and handling instructions.

ConstantColor™ CMH G12

Single Ended Ceramic Metal Halide Lamps

20W, 35W, 70W and 150W

Product information

ConstantColor™ CMH lamps combine the HPS technology (providing stability, efficiency & uniformity) and the Metal Halide Technology (providing bright white quality light) to produce highly efficient light sources with good colour rendering and consistent colour performance through life. This is achieved by using the ceramic arc tube material from the Lucalox™ lamp, which minimises the chemical changes inside the lamp through life. When combined with the halide doses used in Arcstream™ Metal Halide lamps the quality and stability of the dose maintains the colour consistency. Hence the name ConstantColor™ CMH.

Metal halide lamps, traditionally made with quartz arc tubes, are prone to colour shift through life and lamp-to-lamp colour variation. Some of the dose, e.g. sodium, (an important component of metal halide lamps), can migrate through quartz to cause colour shift and loss of light through life. The ceramic arc tube resists this material loss, can be manufactured to tighter tolerances and withstands a higher temperature to provide a more constant colour.

Features

- Consistent colour over life
- Colour uniformity lamp to lamp
- Bright light – in a very compact size
- Excellent colour rendition
- Improved reliability due to 3 part design
- Up to 96 LPW efficacy
- Up to 18,000 hours life
- UV control
- Easy retrofit for Quartz Metal Halide lamps
- Two colour temperatures 3000K and 4200K



Single ended format

Single Ended Ceramic Metal Halide lamps are made to provide symmetrical beam distribution using the axial configuration of the discharge arc. A variety of beam angles are possible and adjustable beam control can be built into the luminaire.

This compact lamp shape enables luminaire size to be minimised and the bi-pin lamp base enables easy changing with front access.

Applications areas



Retail



Office



Showbiz



Hospitality



Commercial areas /
city beautification / architectural



Specification summary

Description	Wattage	Colour	Product Code
CMH20/T/UVC/U/830/G12 Plus	20	3000K	42708
CMH35/T/UVC/U/830/G12 Plus	35	3000K	43272
CMH35/T/UVC/U/942/G12	35	4200K	92141
CMH70/T/UVC/U/830/G12	70	3000K	20005
CMH70/T/UVC/U/942/G12	70	4200K	20013
CM150/T/UVC/U/830/G12	150	3000K	20012
CM150/T/UVC/U/942/G12	150	4200K	20014

General	Unit	20W Plus 3000K	35W Plus 3000K	35W 4200K	70W 3000K	70W 4200K	150W 3000K	150W 4200K
Product code		42708	43272	92141	20005	20013	20012	20014
Nominal wattage	[W]	20	35	35	70	70	150	150
Format		Single ended	Single ended	Single ended	Single ended	Single ended	Single ended	Single ended
Bulb type		T4.5	T4.5	T4.5	T6	T6	T6	T6
Bulb material		UVC Quartz	UVC Quartz	UVC Quartz	UVC Quartz	UVC Quartz	UVC Quartz	UVC Quartz
Bulb finish		Clear	Clear	Clear	Clear	Clear	Clear	Clear
Arc gap	[mm]	3.4	4.7	4.3	7.4	5.5	10.5	10.0
Base		G12	G12	G12	G12	G12	G12	G12

Operating conditions

Burning position Universal

Luminaire characteristics Enclosed

Notes:

- 1) Note that the lamp voltage inside the luminaire should not deviate by more than 5V from the bare lamp voltage in free air.
- 2) Thermal protection required

Electrical characteristics*

Lamp power (rated)	[W]	20	39	39	72	72	146	146
Lamp voltage	[V]	90	90	90	90	90	93	93
Lamp current	[A]	0.226	0.43	0.43	0.98	0.98	1.85	1.85
Max. ignition Voltage	[kV]	5.0	5.0	5.0	5.0	5.0	5.0	5.0
Min. ignition Voltage	[kV]	3.0	3.0	3.0	3.0	3.0	3.0	3.0
Extinction voltage (% of rated input voltage)	[%]	90 (Max.)	90 (Max.)	90 (Max.)	90 (Max.)	90 (Max.)	90 (Max.)	90 (Max.)

* The specification provides typical performance data for 70W & 150W operating from a 50Hz mains sinewave supply at rated power, and for 20W & 35W operating on typical electronic ballast. Actual values depend on ballast, supply voltage and application. 20W to be used only with an electronic ballast.

Specification summary

Photometric characteristics		20W Plus 3000K	35W Plus 3000K	35W 4200K	70W 3000K	70W 4200K	150W 3000K	150W 4200K
Product code		42708	43272	92141	20005	20013	20012	20014
100 hrs lumens	[lm]	1650	3400	3200	6200	6300	14000	13000
Typical lumen change with burning position – vertical to horizontal	[lm]	100-150	100-150	100-150	100-150	100-150	100-150	100-150
Typical voltage change with burning position – vertical to horizontal	[V]	8	8	8	8	8	8	8
Correlated colour temperature	[K]	3000	3000	4000	3000	4200	3000	4200
Chromaticity X		0.435	0.435	0.379	0.435	0.370	0.435	0.365
Chromaticity Y		0.400	0.400	0.374	0.400	0.371	0.400	0.365
Colour rendering Index	[Ra]	80+	84+	88+	83+	90+	80+	90+
Luminous efficacy	[lm/W]	83	87	82	86	88	96	89

1) Photometric characteristics refer to lamp performance after 100hrs burning.

2) 70W & 150W data are based on operation from a conventional magnetic ballast. Improved performance can be achieved using an electronic ballast.

3) 35W data are based on operation from an electronic ballast. Lamps can run on conventional ballast with a small reduction in performance.

4) 20W designed for operation only from an electronic ballast.

Starting and warm-up characteristics*

Time to start (at 25 °C)	[sec.]	< 2	< 2	< 2	< 2	< 2	< 2	< 2
Time to start – cold box test at -30 °C	[sec.]	< 2	< 2	< 2	< 2	< 2	< 2	< 2
Hot restart time	[min.]	< 4	< 7	< 7	15	15	15	15
Warm-up time (for 90% lumens)	[min.]	1.2	2	2	3	3	3	3

*Typical values (actual values are ballast and ignitor dependent)

Through life performance

Lumen maintenance at 40% rated life (mean lumens)	[%]	68	68	78	72	76	81	74
Average rated life (electronic ballast)	[h]	12,000	16,500	18,000	15,000	15,000	12,000	12,000
Average rated life (magnetic ballast)	[h]	N/A	15,000	12,000	15,000	15,000	12,000	12,000

Maximum operating temperatures*

Maximum allowed bulb temperature (horizontal orientation, thermocouple attached above burner)	[°C]	500	500	500	500	500	650	650
Maximum pinch temperature (vertical base up orientation)	[°C]	350	350	350	350	350	350	350

*Temperatures above which lamp performance or reliability is impaired.

Dimensions

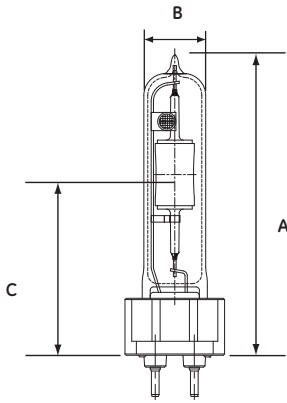

	20W	35W	70W	150W
Product code	42708	92141	20005	20012
A Length [mm] max	90	90	90	100
B Diameter [mm] nominal	14.5	14.5	19	19
C LCL [mm] nominal	56	56	56	56

Spectral power distribution

Spectral power distribution curves are given in the following diagrams

Spectral power distribution 3000K

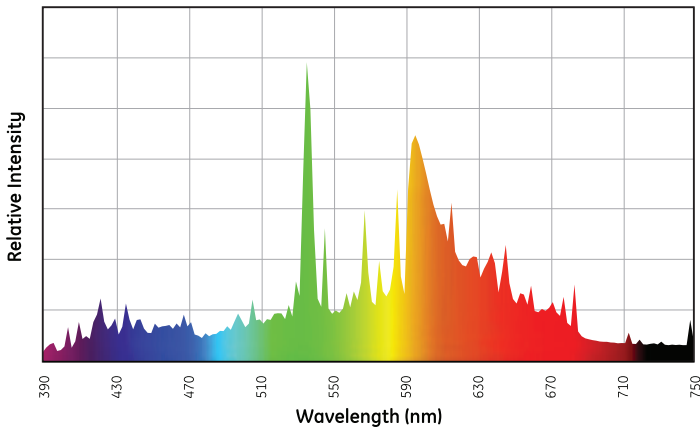

Spectral power distribution 4200K

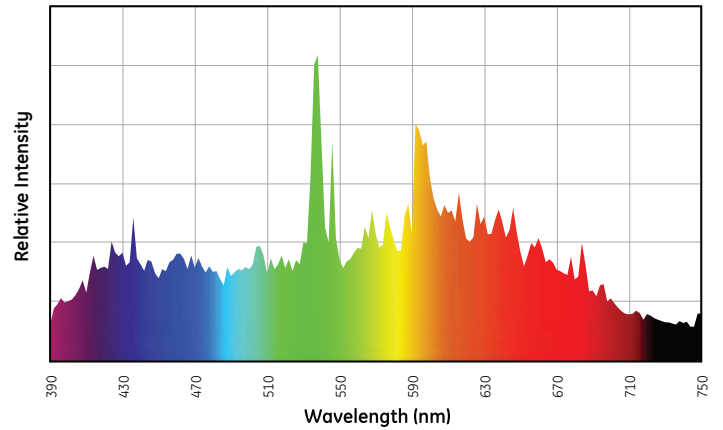

Distribution of luminous intensity

The following diagrams show typical polar light intensity curves for the lamp in vertical base-up orientation.

Horizontal plane polar intensity curve

CMH G12 35W

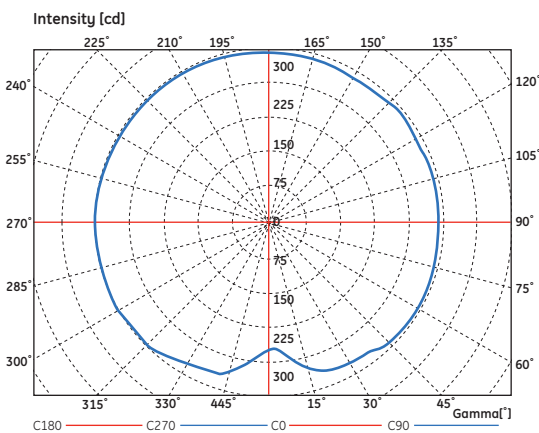

Vertical plane polar intensity curve

CMH G12 35W

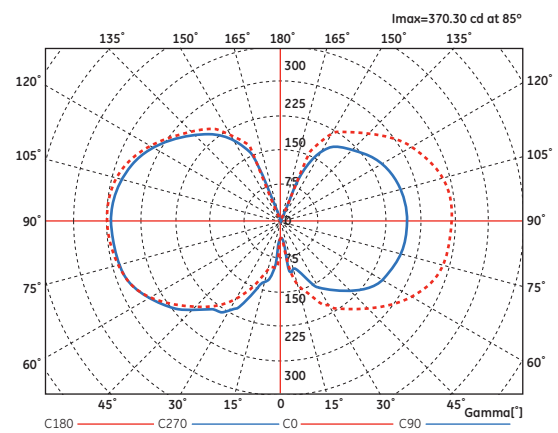

CMH G12 70W

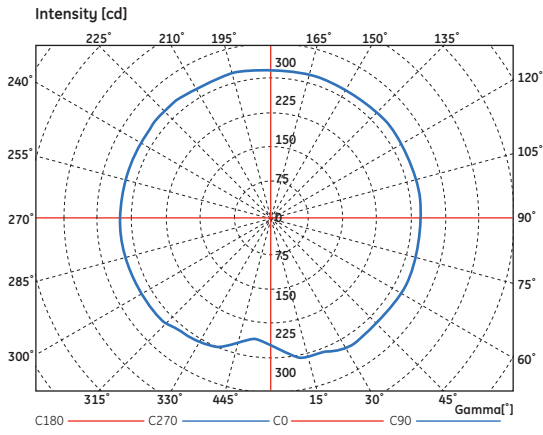

CMH G12 70W

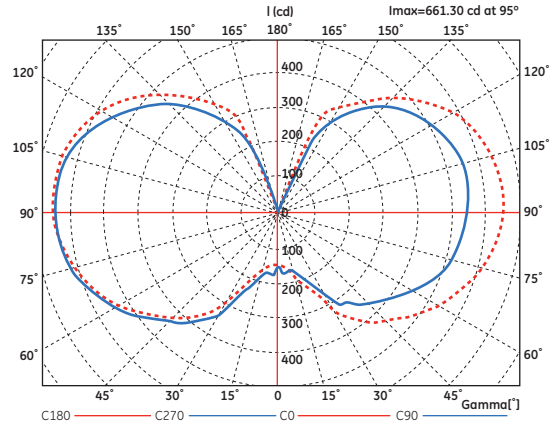

CMH G12 150W

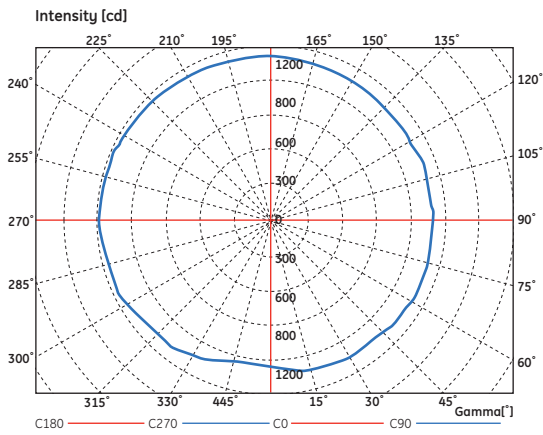

CMH G12 150W

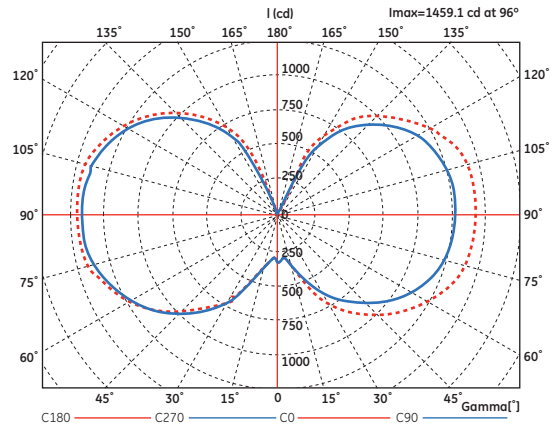

Lamp life

Life survival graphs are shown for statistically representative batches of lamps operated under controlled nominal conditions with an 11 hours per start switching cycle. The declared lamp life is the median life, which is when 50% of the lamps from a large sample batch would have failed. Lamp life in service will be affected by a number of parameters, such as supply voltage variation, switching cycle, operating position, mechanical vibration, luminaire design and control gear. The information is intended to be a practical guide for comparison with other lamp types. The determination of lamp replacement schedules will depend upon the acceptable reduction in illuminance and the relative costs of spot and group replacement.

CMH G12 20W 3000K

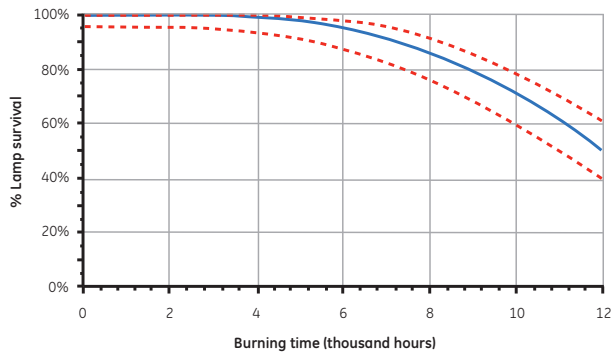

CMH G12 35W 3000K

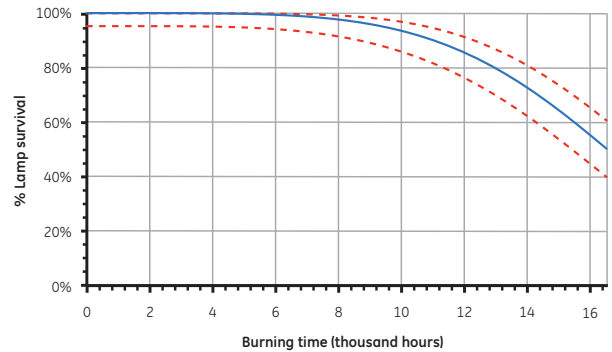

CMH G12 35W 4200K

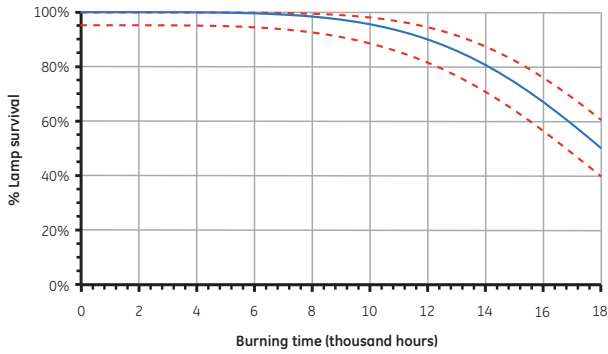

CMH G12 70W 3000K and 4200K

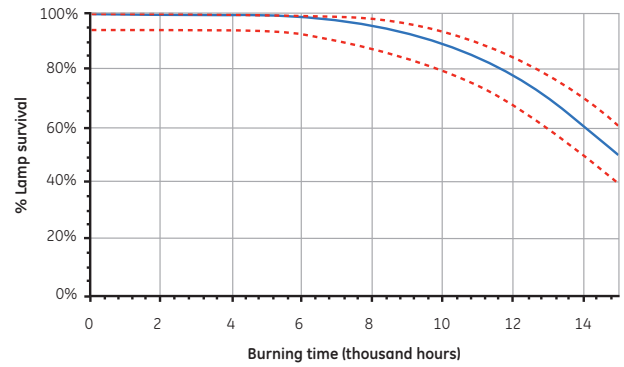

CMH G12 150W 3000K and 4200K

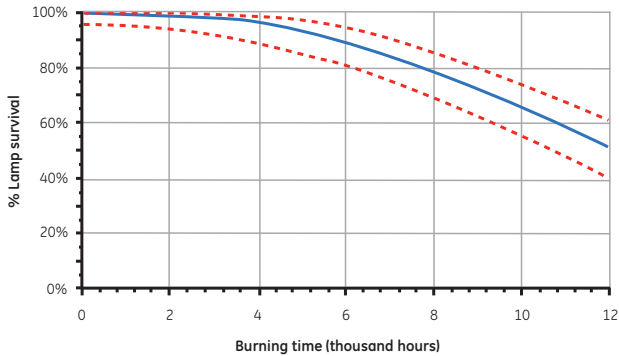

Lumen maintenance

The lumen maintenance graphs show light output performance through life for statistically representative batches of lamps operated under controlled conditions with an 11 hours per start switching cycle. A common characteristic for all metal halide lamps is a reduction in light output and a slight increase in power consumption through life. Consequently there is an economic life at which lamp efficacy falls to a level when lamps should be replaced to restore design illumination levels. In areas where multiple lamps are installed, consideration should be given to a group lamp replacement programme to maintain uniform illumination levels. Curves represent operating conditions for an 11 hours per start switching cycle, but less frequent switching will improve lumen maintenance.

Note: The representative curves are shown for Vertical Base-Up lamp orientation unless otherwise specified. Lumen maintenance performance is significantly improved in the Horizontal burning position.

Lumen maintenance CMH G12 20W 3000K

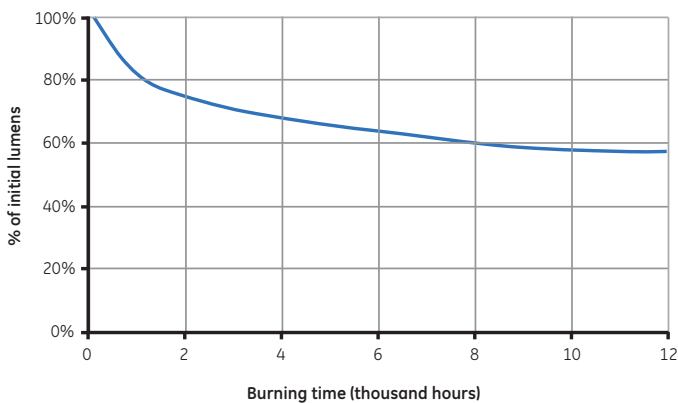

Lumen maintenance CMH G12 35W 3000K

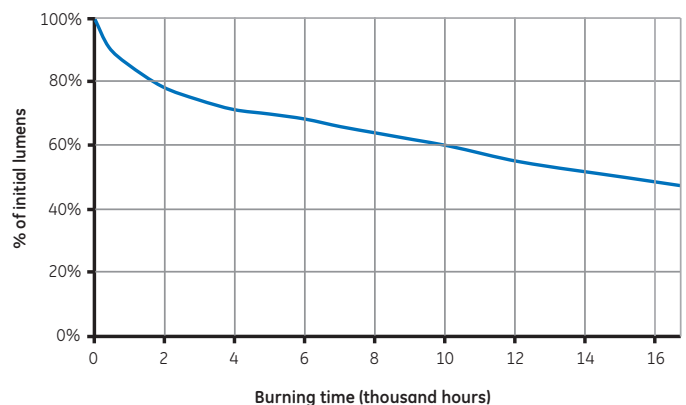

Lumen maintenance CMH G12 35W 4200K

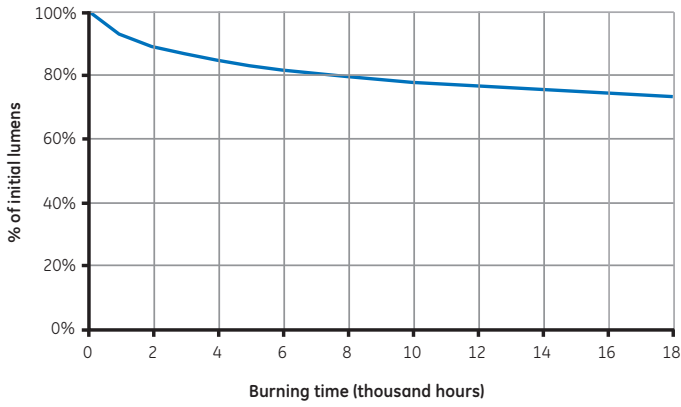

Lumen maintenance CMH G12 70W 3000K

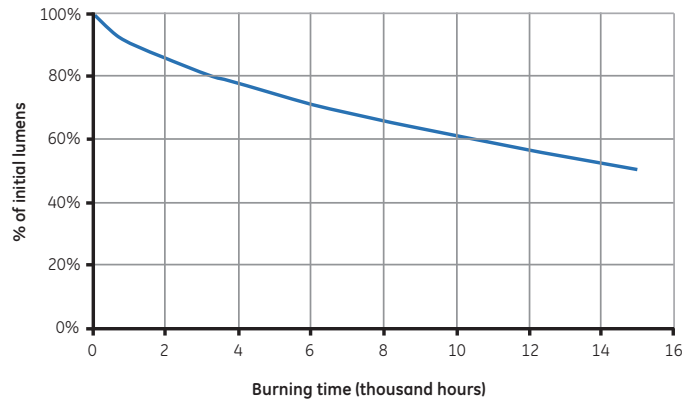

Lumen maintenance CMH G12 70W 4200K

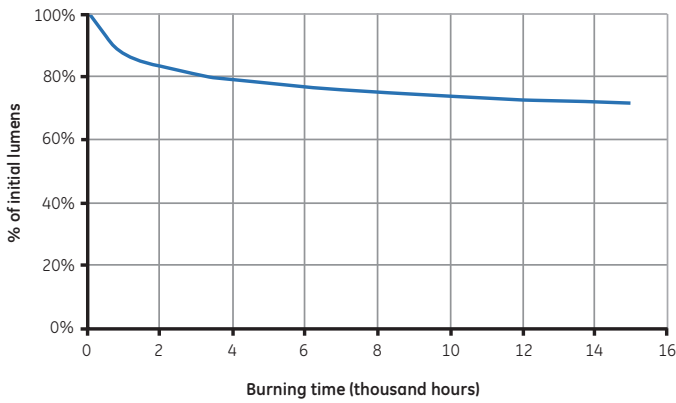

Lumen maintenance CMH G12 150W 3000K

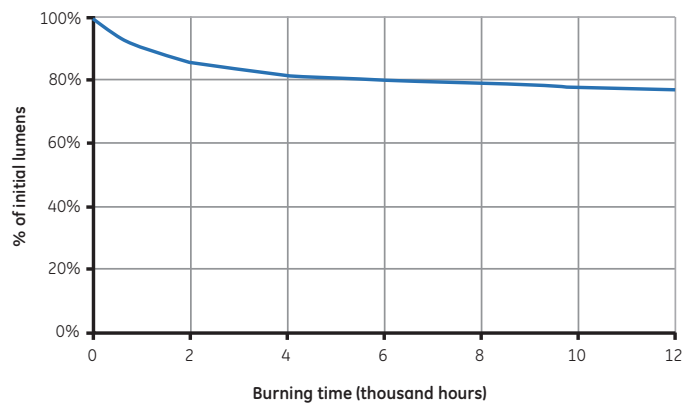

Lumen maintenance CMH G12 150W 4200K

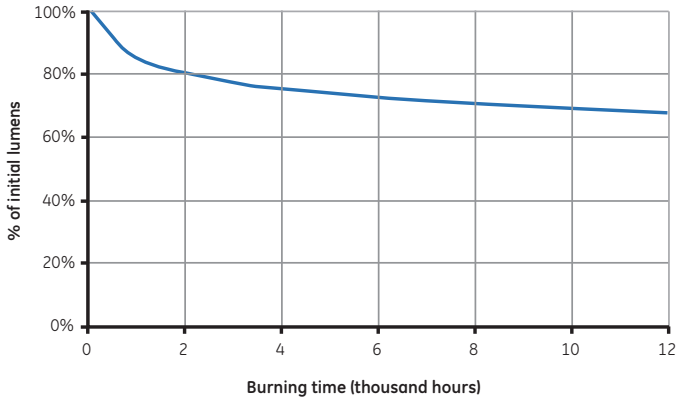

Warm-up characteristics

During the warm-up period immediately after starting, lamp temperature increases rapidly and mercury and the metal halides evaporate within the arc tube. The lamp current and voltage will stabilise in less than 4 minutes. During this period the light output will increase from zero and the colour will approach the correct visual effect as each metallic element becomes vaporised.

Typical warm-up characteristics

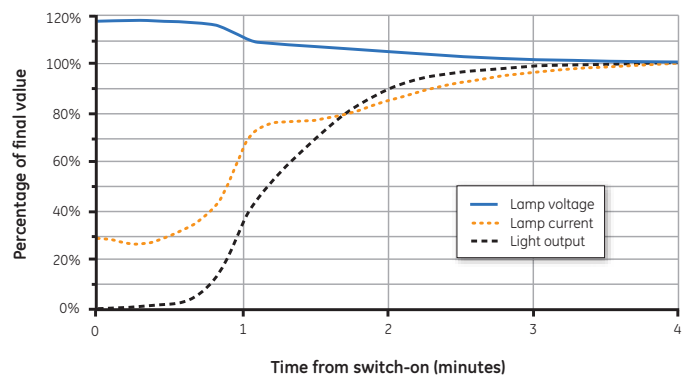

Supply voltage sensitivity

The line supply voltage applied to the control gear should be as close to rated nominal as possible. Lamps will start and operate at 10% below rated supply voltage but this should not be considered as a normal operating condition. In order to maximise lamp survival, lumen maintenance and colour uniformity, supply voltage and rated ballast voltage should be within $\pm 3\%$. Supply variations of $\pm 5\%$ are permissible for short periods only. Where supply voltage variation is likely to occur the use of electronic control gear should be considered as this type of equipment is normally designed to function correctly for a voltage range of 200-240V.

Dimming

In certain cases, dimming may be acceptable, subject to further testing. Contact your GE representative for more information. Large changes in lamp power alter the thermal characteristics of the lamp resulting in lamp colour shift and possible reduction in lamp survival.

Flicker

With conventional ballasts there will be a line frequency (50Hz) flicker from ConstantColor™ CMH lamps as with all other discharge lamps. For example a 150W single ended lamp has a flicker value of approximately 1.5%. Normally this is not of concern, but, where visual comfort and performance is critical, the use of electronic control gear should be considered. Suitable electronic ballasts for ConstantColor™ CMH lamps provide square wave operation in the 70-400Hz range and eliminate perceptible flicker. A horizontally operated ConstantColor™ CMH lamp, such as a double ended type, will also produce noticeably less flicker.

End-of-life conditions

The principal end-of-life failure mechanism for CMH lamps is arc tube leakage into the outer jacket. High operating temperature inside the arc tube causes metal halide dose material to gradually corrode through the ceramic arc tube wall, eventually resulting at normal end-of-life in leakage of the filling gas and dose. Arc tube leakage into the outer jacket can be observed by a sudden and significant lumen drop and a perceptible colour change (usually towards green).

The above situation is often accompanied by the so-called rectification phenomena. This occurs when a discharge is established between two mount-frame parts of different material and/or mass, causing asymmetry in the electrical characteristic of the resulting discharge current. Rectification can lead to overheating of the ballast, therefore conventional magnetic ballasts must conform to requirements of the IEC61167 lamp standard by incorporating protection to maintain safety and prevent damage.

See Fusing Recommendations.

End-of-life cycling

A condition can exist at end-of-life whereby lamp voltage rises to a value exceeding the voltage supplied by the control gear. In such a case the lamp will extinguish and on cooling restarts when the required ignition voltage falls to the actual pulse voltage provided by the ignitor. During subsequent warm-up the lamp voltage will again increase, causing extinction. This condition is known as end-of-life cycling. Normally cycling is an indication that lamp end-of-life has been reached, but it can also occur when lamps are operated above their recommended temperature. Lamp voltage at 100 hours life should not increase by more than 5V when operating in the luminaire, when compared to the same lamp operating in free-air. A good luminaire design will limit lamp voltage rise to 3V.

It is a good practice to replace lamps that have reached end-of-life as soon as possible after failure, to minimise electrical and thermal stress on ignitor components. The use of a 'timed' or 'cut-out' ignitor is not a specific requirement for ConstantColor™ CMH lamps, but is worth considering as a good optional safety feature which also prolongs the life of ignitor internal components, lamp holder contact surfaces, and fixture wiring.

The operating period of a timed/cut-out ignitor must be adequate to allow lamps to cool and restart. A period of 10 to 15 minutes continuous or intermittent operation is recommended before the ignitor automatically switches off. Timed/cut-out ignitors, specifically offered for High-Pressure Sodium lamps, where the period of operation is less than 5 minutes, are not suitable for ConstantColor™ CMH lamps.

UV and damage to sensitive materials

The wall of the bulb, which is produced with specially developed 'UV Control' material, absorbs potentially harmful high energy UV radiation emitted by the ceramic arc tube.

The use of UV control material together with an optically neutral front glass cover allows the lamp to significantly reduce the risk of discolouration or fading of products. When illuminating light-sensitive materials or at high light levels, additional UV filtration is recommended. Luminaires should not be used if the front glass is broken or missing. It is recommended that a safety interlock switch is incorporated into the luminaire to prevent operation when the luminaire is opened.

Although PET determines limits of human exposure to lamp UV, the risk of fading of materials due to UV can be quantified by a damage factor and a risk of fading. The risk of fading is simply the numerical product of the illuminance, exposure time and damage factor due to the light source.

Finally the selection of luminaire materials should take into consideration the UV emission. Current UV reduction types on the market are optimised for UV safety of human eye and skin exposure. However, luminaire materials may have different wavelength dependent response functions. Designers must take account of emission in each of the UV-A, UV-B and UV-C spectral ranges as well as material temperatures when designing luminaires.

Typical values for UV-A, UV-B and UV-C range radiation can be found in the table below.

		20W 3000K	35W 3000K	35W 4200K	70w 3000K	70w 4200K	150w 3000K	150w 4200K
UV-PET performance								
UV-C ¹	220-280nm	0.036	0.033	0.020	0.014	0.011	0.017	0.010
UV-B ¹	280-315nm	0.049	0.043	0.040	0.006	0.009	0.011	0.008
UV-A ¹	315-400nm	10.17	9.378	13.870	6.980	9.800	7.552	9.752
UVC/UVB		0.72	0.767	0.509	2.365	1.321	1.583	1.188
UVB/UVA		0.005	0.005	0.003	0.001	0.009	0.001	0.001
E_{eff}^2		1.04	0.94	0.68	0.30	0.28	0.40	0.26
PET (h)		16	18	26	54	64	43	65
Risk Group	IESNA RP-27.3-96	Exempt	Exempt	Exempt	Exempt	Exempt	Exempt	Exempt

¹ $\mu\text{W}/(\text{cm}^2) / 500 \text{ Lux}$

² mW / klm

Information on luminaire design

Ballasts

ConstantColor™ CMH lamps operate from the same type of ballast as conventional quartz technology metal halide lamps of the same nominal power. IEC 61167 MH lamp standard and IEC 62035 HID lamp safety standard specify use of ballast thermal protection or equivalent protection device in the circuit. This safety device will protect the ballast and fixture from overheating damage at lamp end-of-life should rectification occur due to electrode imbalance or arc tube failure. The IEC61167 requirement applies to both ceramic and quartz arc tube metal halide lamps of the UV-A, UV-B, and UV-C spectral ranges as well as material temperatures when designing luminaires. ConstantColor™ CMH lamps are compatible with a list of approved ballasts; contact your GE representative for more information.

Stray magnetic field of conventional ballast

At the design stage for fixtures incorporating the control gear, careful consideration should be given to the physical layout of the lamp and ballast. The relative positions and distance between lamp and ballast can adversely affect lamp performance and drastically reduce lamp life survival.

Conventional magnetic ballasts can produce a stray magnetic field and if the lamp is placed within this field, "bowing" of the arc in the discharge tube can occur. Since ceramic is a very rigid material severe arc bowing can cause high thermal stress leading to cracking or rupture of the arc tube resulting in failure of the lamp early in life.

Such bowing of the arc can also affect the quartz arc tube in conventional metal halide lamps, but cracking or rupture failure is less likely since quartz softens at the resulting higher wall temperature causing the arc tube to become swollen. Excessive swelling of a quartz arc tube can however also result in cracking or rupture failure.

In fixtures where the ballast is necessarily placed close to the lamp, use of magnetic shielding is essential. Another solution is to use an electronic ballast, which eliminates the need for an ignitor, simplifies wiring, reduces the risk of stray magnetic field and eliminates light output flicker.

Containment requirement

ConstantColor™ CMH lamps operate above atmospheric pressure, therefore a very small risk exists that the lamp may shatter when the end of life is reached. Though this failure mode is unlikely, containment of shattered particles is required as prescribed by IEC 62035.

Single ended lamps should only be used in a suitable enclosed luminaire with front cover glass capable of containing the fragments of a lamp should it shatter.

Control gear and accessories

Electronic ballasts

A range of GE electronic ballasts have been introduced to complement the ConstantColor™ Ceramic Metal Halide lamps. Power controlled electronic ballasts suitable for operation of Ceramic Metal Halide lamps are available from various gear manufacturers.



Advantages are:

- Good regulation against supply voltage variation
- Improved lamp colour consistency
- Elimination of lamp flicker
- Reduced weight of control gear
- Reduced electrical power losses
- Ballast noise reduced/eliminated
- Single piece compact unit
- Reduced wiring complexity in the luminaire

For selecting proper ballast for CMH lamps please see separate CMH ballasts data sheet.

Superimposed ignitors

In many installations Ceramic Metal Halide lamps are operated from a conventional magnetic ballast in conjunction with a superimposed ignitor. These ignitors generate starting pulses independently from the ballast and should be placed close to the lamp, preferably within the luminaire. Wiring between ignitor and lamp should have a maximum capacitance to earth of 100pF (length equivalent to less than 1 Metre) - contact the ignitor manufacturer for details of specific ignitor types. A typical circuit diagram is shown:

Typical superimposed ignitor circuit

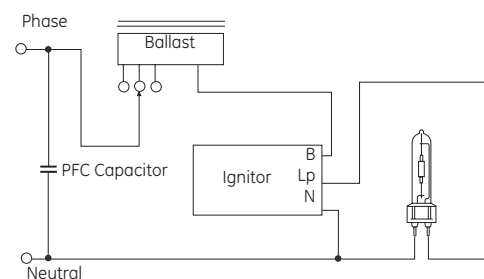

Suitable ignitors

Suitable high-energy (superimposed) ignitors recommended by control gear manufacturers are listed below. Check with suppliers for their current range of ignitors. Lamp re-starting under warm lamp conditions can take up to 15 minutes. Suitable ignitors to achieve a warm restart of less than 15 minutes include the following, however the list may not be fully inclusive:

Maker	Products				
APF	SP23				
BAG Turgi	NI 150 SE	NI 150 SE-TM20	MZN 150 SE-C	Ni 400 LE/3.5 A	NI 400 LE/3.5 A-TM20
ERC	AZ A 1.8	AZ P 1.8	AZ P 3.0	AZ P 1.8 T3	AZ P 3.0 T3
Helvar	L-150	LSI-150T20			
Optima	ZG 0.5	ZG 2.0	ZG 2.0 D	ZG 4.5 D	
Parmar	PAV400	PCX400	PXE100		
Philips	SU20S				
Thorn	G53459	G53498	G53476	G53504.TB	
Tridonic	ZRM 1.8-ES/B	ZRM 2.5-ES/B	ZRM 4.5-ES/B	ZRM 6-ES/B	ZRM 2.5-ES/D
Vossloh-Schwabe	Z 150	Z 150 K	Z 150 A10	Z 150 A10	Z 250

Impulser ignitors

Impulser type ignitors use the ballast winding as a pulse transformer and can only be used with a matched ballast. Always check with the ballast and ignitor supplier that components are compatible. Longer cable lengths between ballast & ignitor and the lamp are possible due to the lower pulse frequency generated, giving greater flexibility for remote control gear applications. Ignitor pulse characteristics at the lamp must however comply with specified minimum values for ConstantColor™ CMH lamps under all conditions.

Typical impulser ignitor circuit

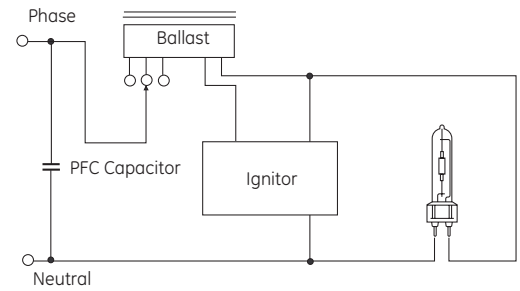

Other ignitor related considerations

Timed or cut-out ignitors

The use of a 'timed' or 'cut-out' ignitor is not a specific requirement for ConstantColor™ CMH lamps but it is a good optional safety feature worth considering to protect the ignitor from overheating and to prolong its life. If used, the timed period must be adequate to allow lamps to cool and restart as described in the previous section. A period of 10-15 minutes continuous or intermittent operation is recommended before the ignitor automatically switches off. Timed ignitors specifically offered for High-Pressure Sodium lamps where the period of operation is only about 5 minutes are not suitable for ConstantColor™ CMH lamps.

Hot re-strike

All ratings re-strike within 15 minutes following a short interruption in the supply. Actual re-strike time is determined by the ignitor type, pulse voltage and cooling rate of the lamp. Instant hot re-strike is only possible using a suitable very high voltage ignitor and a double ended lamp. GE Lighting should be consulted when considering use of an instant hot re-striking system.

Warm re-starting

The combined characteristics of ceramic arc tube material and vacuum outer jacket result in ConstantColor™ CMH lamps cooling relatively slowly. It is possible with low energy ignitors to reach the required breakdown voltage but not create a full thermionic discharge. Under these conditions the lamp can remain very warm and be prevented from cooling to a temperature at which the arc can be re-established. To avoid this, turn off the power supply for approximately fifteen minutes or change to a suitable high energy ignitor from the list given in the superimposed ignitor section.

Fusing recommendations

For a very short period immediately after switch-on, all discharge lamps can act as a partial rectifier and a conventional magnetic ballast may allow higher than the normal current to flow. At switch-on the short duration surge current drawn by the power factor correction capacitor can be high. In order to prevent nuisance fuse failure at initial switch-on, the fuse rating must take these transient conditions into account. A separate technical data sheet providing additional explanation and information for the fusing of High Intensity Discharge lighting circuits is available from GE Lighting. Fusing of individual fixtures is recommended, in order to provide added protection for end-of-life conditions when lamp rectification can also occur.

Number of lamps	1	2	3	4	5	6
35W Fuse Rating (A)	4	4	4	4	4	4
70W Fuse Rating (A)	4	4	4	6	6	10
150W Fuse Rating (A)	4	6	10	10	16	16

Safety warnings

The use of these products requires awareness of the following safety issues:

Warning

- Risk of electric shock - isolate from power supply before changing lamp
- Strong magnetic fields may impair lamp performance, and in the worst case could lead to lamp shattering.

Use in enclosed fixtures to avoid the following:

- Risk of fire
- A damaged lamp emits UV radiation which may cause eye/skin injury, remove and dispose of broken lamp
- Unexpected lamp shattering may cause injury, fire or property damage, use in luminaire with front cover made of glass

Caution

- Risk of burn, allow lamp to cool before handling
- Lamp may shatter and cause injury if broken
- Arc tube fill gas contains Kr-85

Always follow the supplied lamp operation and handling instructions.