



Brand of NTN Group

Technical data

UCF206N

Bearing units



Grey cast housing, radial insert ball bearing with socket set screws, seal with slinger

KIT CONTENT

UC206G2, F206N

VISUAL (S)

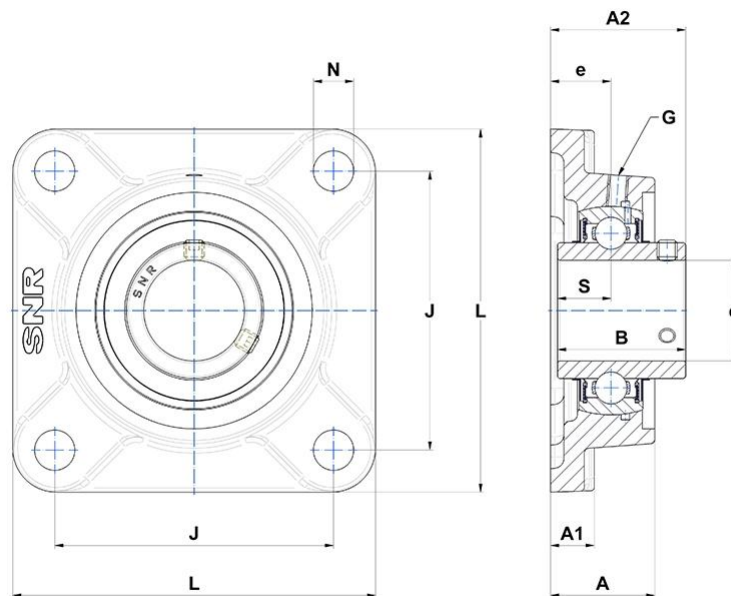

PRODUCT DEFINITION

Brand	SNR
A - Housing height	31 mm
A1 - Housing foot height / flange height	13 mm
A2 - Total height from mounting surface	40,2 mm
B - Width of Inner Ring	38,1 mm
d - Shaft diameter	30 mm



NTN Europe

1 rue des Usines · BP 2017 · 74010 Annecy Cedex · France · Tel. +33 (0)4 50 65 30 00
S.A. au capital de 322 639 919 € · RCS ANNECY B 325 821 072 · Id. Fiscale : FR 48 325 821 072
SIRET 325 821 072 00015 · Code APE 2815 Z · Code NACE 28.15

PRODUCT DEFINITION

e - Distance mounting surface to bearing center	18 mm
G - Grease fitting	M6x1
J - Mounting holes distance	83 mm
L - Housing width / diameter	108 mm
N - Mounting hole dimension	12 mm
S - Distance front side/bearing centre	15,9 mm

PRODUCT PERFORMANCE

C - Dynamic load rating	19500000 mN
C0 - Static load rating	11200000 mN
Operating temperature min.	253,15 °K
Operating temperature max.	373,15 °K

OTHER FEATURES

Mass	1,1 kg
Recommended tightening torque for set screw	5.5 N-m

