

momit
HOME
THERMOSTAT

Installation
guide



Index

momit Home System.....	3
Products presentation.....	4
Characteristics	5
Possible configurations.....	8
Installation	9
Additional content.....	10
Gateway.....	11
Thermostat	12
Extension Kit.....	15
Customise your device.....	19

momit Home System

Products presentation

The **momit Home system** is made up of 3 devices:

- Gateway
- Thermostat
- Extension Kit*

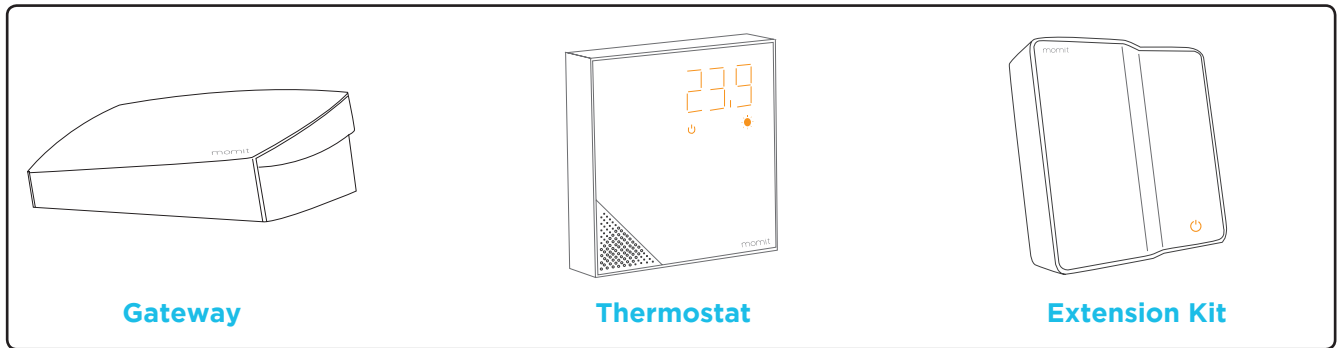

*Sold separately

Characteristics

Gateway

The Gateway is a device that is connected to Internet with an Ethernet cable. It uses wireless 802.15.4 connectivity technology to communicate with other momit Home devices. The Gateway makes it possible for you to control momit Home from your smartphone, tablet or computer by means of the momit App.

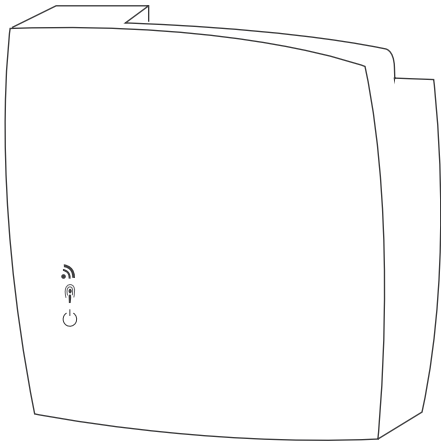

Características:

- Platform registration by means of QR code
- 5V power input (USB)
- Wireless: IEEE 802.15.4
- LED status display
- Ethernet interface
- CE
- RoHS
- Dimensions:
123 x 123 x 44 mm
- Weight: 150 g

Thermostat

Replace your old thermostat with a new smart one. Easy to fit, all you have to do is to remove the current thermostat and fit the momit Home Thermostat.

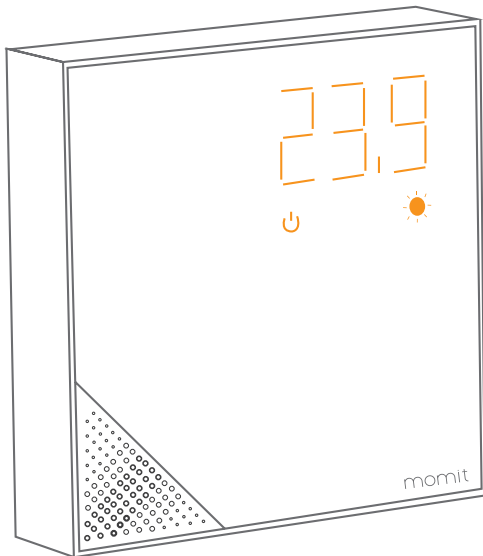

Characteristics:

- Easy to fit
- Boiler control
- Temperature up/down, boiler on/off buttons
- iOS, Android, Windows Phone and Blackberry mobile APP
- Platform registration by means of QR code
- Power input 2 alkaline AA batteries
- Wireless: IEEE 802.15.4
- Temperature, humidity and presence sensor
- $\pm 0.3^{\circ}\text{C}$ temperature accuracy
- LED display
- Relays:
 - 2A at 30 VCC
 - 0.5A at 125 VAC
- CE
- RoHS
- Dimensions: 100x100x25 mm
- Weight: 150 g

Extension Kit

This device enables momit Home Thermostat to control a boiler or underfloor heating wirelessly.

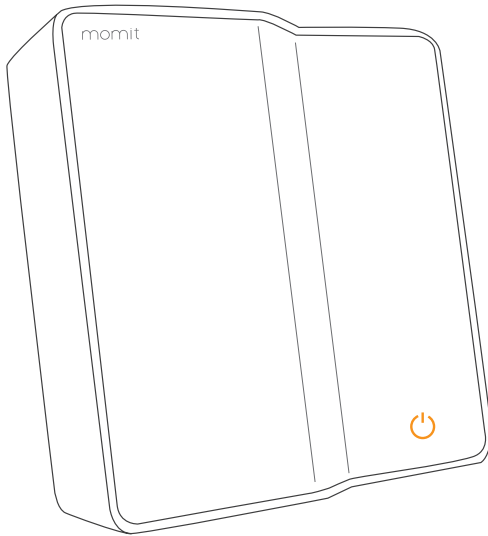

Characteristics:

- An On/Off boiler button
- Platform registration by means of QR code
- 110V/230V 50/60Hz power input
- Wireless: IEEE 802.15.4
- 12A relay
- LED display
- CE
- RoHS
- Dimensions: 103x107x27 mm
- Weight: 150 g

Possible configurations

This section deals with the different momit device combinations to help you select the one that best adapts to your home and needs. The possibilities are as follows:

Boiler heating systems:

a) Gateway + Thermostat: This combination enables you to control your home heating at all times no matter where you are. The Gateway connects your heating system to Internet. Accordingly, you can control your thermostat by means of the momit App over your smartphone, tablet or computer. You can add as many thermostats as you like.

b) Gateway + Thermostat + Extension Kit: This combination provides you with all the functions of the previous option with the added advantage of being able to control the boiler with a mobile device that can be placed in any room in the house. You can add as many thermostats as you like.

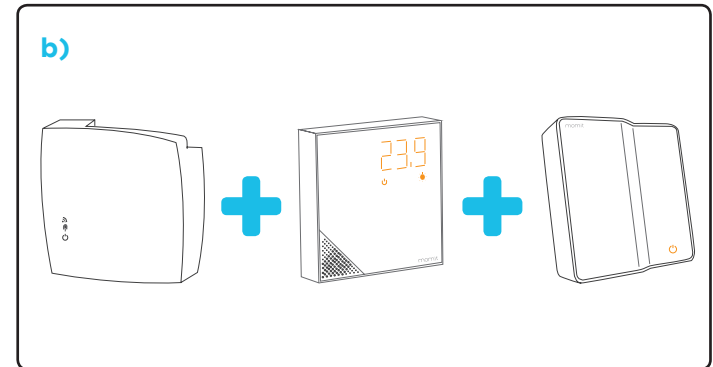
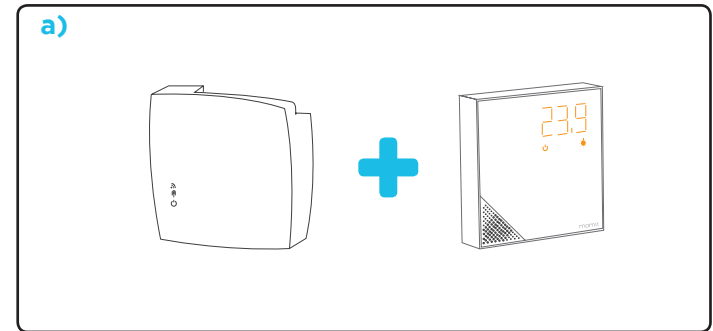

Installation

Warning!

- Read these instructions carefully before starting the installation.
- momit devices must be installed in accordance with current regulations.
- If you are going to install an Extension Kit, make sure that the power has been cut off before proceeding with the installation.

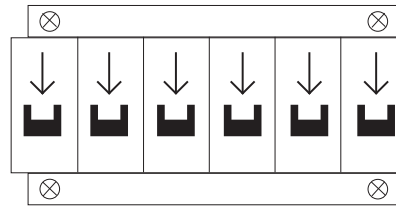
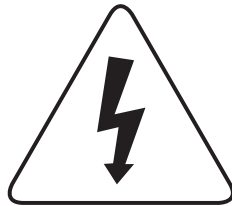

Additional content

Gateway

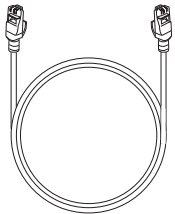

Ethernet cable

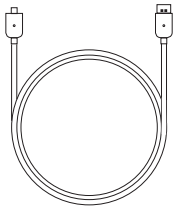

USB cable

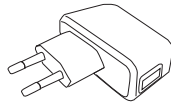

Power
adapter

Thermostat

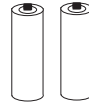

2 AA 1.5V 2700
mAh alkaline
batteries



2 M3x30
screws



2 raw plugs

Extension Kit

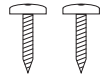

2 M3x30
screws



2 raw plugs

Gateway

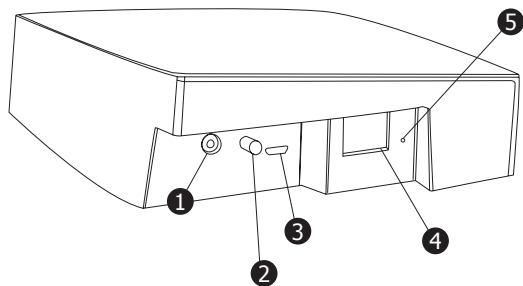

- ❶ Jack connector
- ❷ On/Off
- ❸ MicroUSB connector
- ❹ Ethernet
- ❺ Reset

You must connect this device first. Follow these steps to do so:

1. Connect it to the mains by means of the USB cable (3).
2. Connect the Ethernet cable (4) to the router in your home.
3. Wait until the 3 status LEDs are on before continuing with the installation.

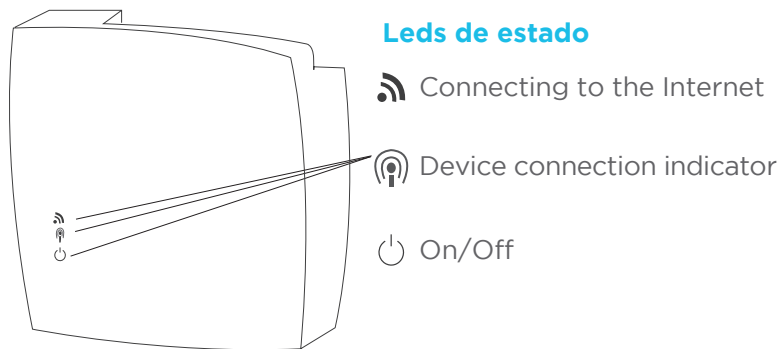
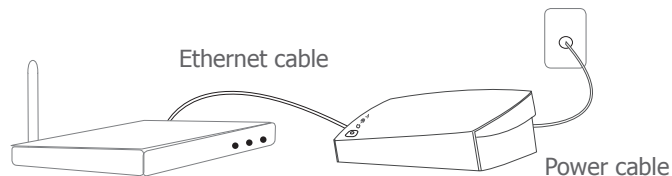

Thermostat

1. Remove the connection box at the back of the thermostat (part B).

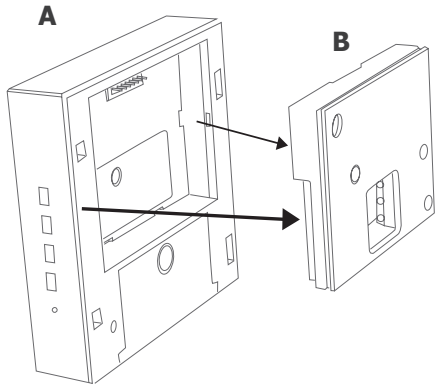

2. Insert the boiler connection wires through the gap in the part.

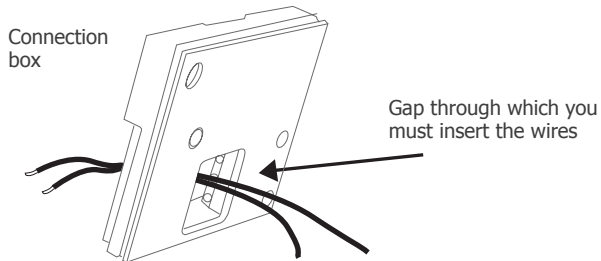

3. Screw the connection box to the wall. Use the two screws that come in the pack to do so.

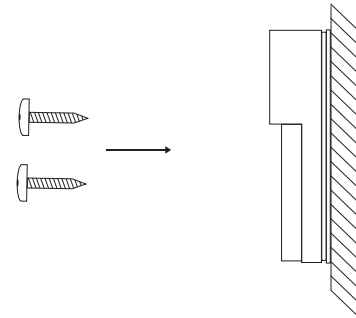

4. Fit the connection wires as shown in the diagram:

Connection diagram

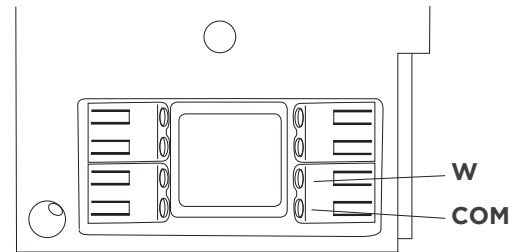

W: boiler
COM: the common boiler

If the wire is rigid you can insert it directly. When it is a flexible wire you may need the help of a punch or pen tip. Press as indicated in the drawing (1) and insert the wire (2).

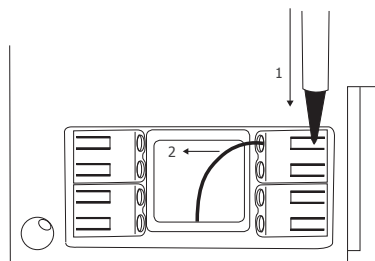
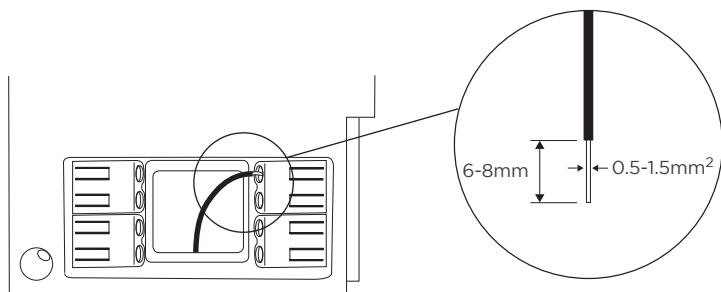

To remove it, first press and then pull on the wire.

4. Insert two AA batteries.

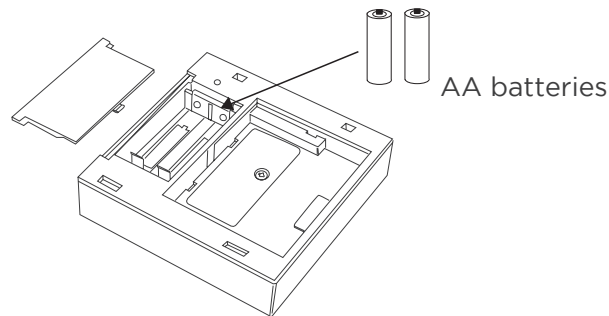

5. Fit the thermostat body (part A) into the connection box (part B) as shown in the following drawing.

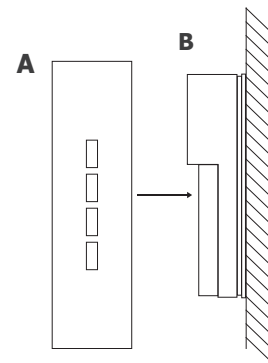

6. After the thermostat is switched on it will synchronise automatically with the Gateway. This process may take less than a minute.

The device connection LED  will be on if everything is working properly. As of now both devices have been connected.

Buttons

- 1 Raise the set temperature
- 2 Lower the set temperature
- 3 On/off mode
- 4 Brightness mode

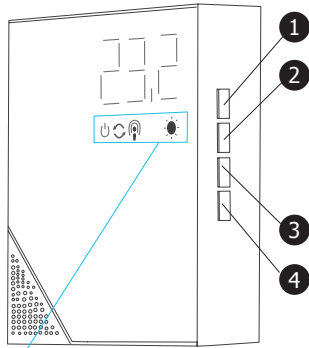

Status LEDs



- Off
- Update in progress
- Gateway connection indicator
- Heating consumption indication

Thermostat placement

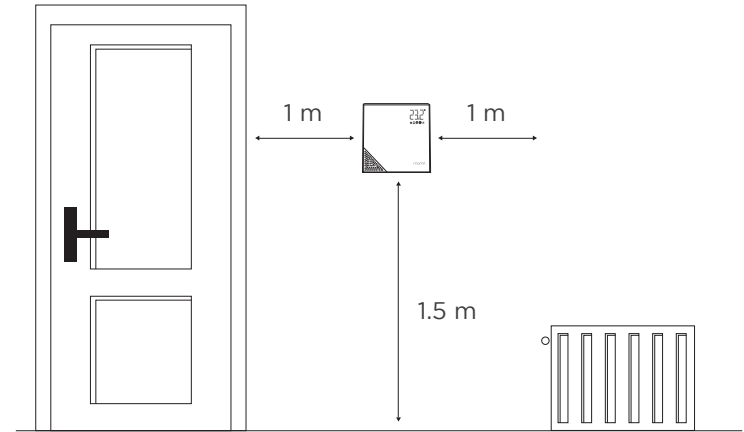

Fit 1 m away
on both sides

1.5 m high

Away from
sources of
cold and heat

Extension kit

1. Insert the installation wires. You can do so in two ways:

Case A:
If the power wires come from the wall, insert them as follows:

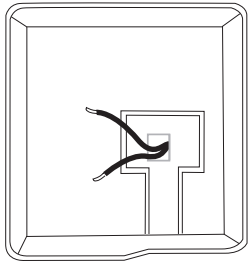

Case A

Case B:
If the power wires come from the boiler, insert them as follows:

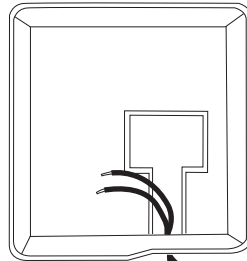

Case B

2. Connect the relay wires to the corresponding terminals, as per the connection diagram, to enable the Extension Kit to control the boiler.

Connection diagram

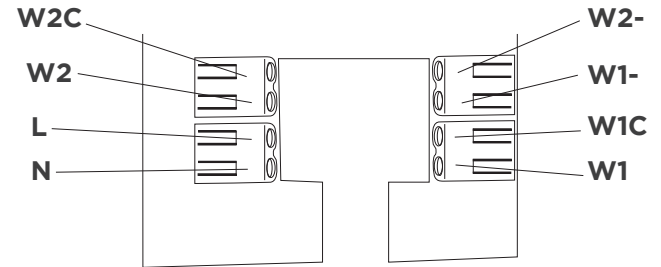

12A relay:

W2C: common connector

W2: boiler connector

W2-: N/A

Power input:

L: Line

N: Neutral

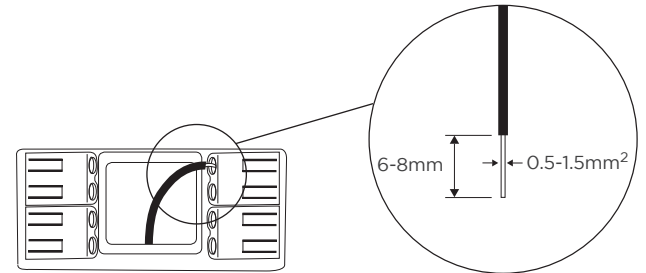

How to connect the wires:

You are recommended to connect the power wires at the end. Take safety measures when working with electricity. Cut off the current in the area where you are working until you have completed the installation.

- Extension Kit requires 110 to 230 VAC input. Connect up **L** and **N** terminals.

- You can control a boiler with Extension Kit by connecting the 2 control wires to **W2** and **W2C**.

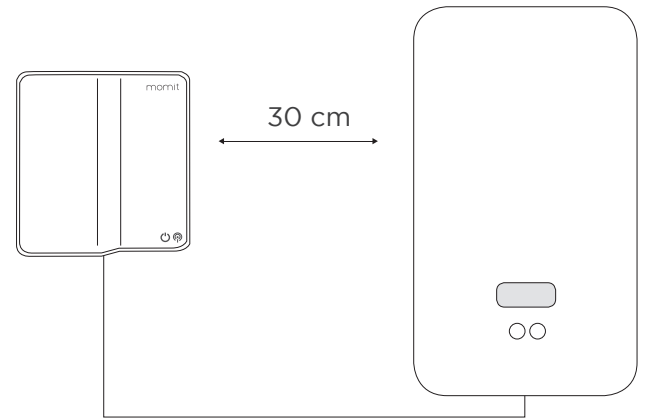

It is recommended to keep the indicated distance if you are fitting it near the boiler.

Identify

Make sure the power has been cut off to the boiler when undertaking these operations.

Identify the thermostat terminals in the boiler manual. They are normally indicated with the following tags **LS-LR**, **TA** or **COM-NO**. You can also identify them by a branch between the two thermostat terminals, in which case you must remove this branch.

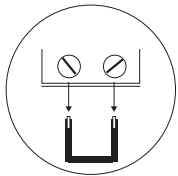

Connect the boiler adapter wires to where the branch is to be found.

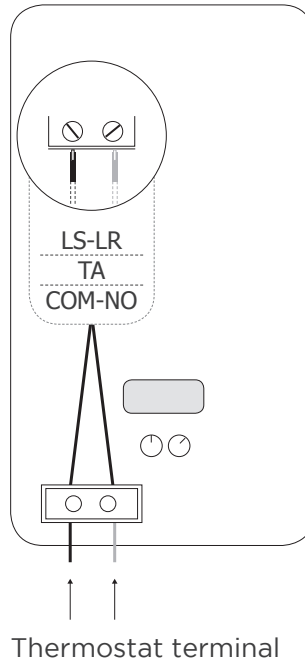

Power

The Extension Kit requires 110 to 230 VAC input. The power terminals from the boiler usually have **L/N** or **P/N** tags.

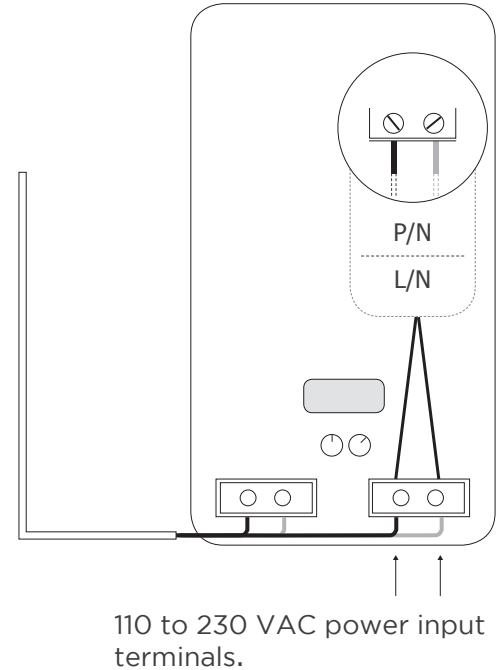

Buttons

- 1 Device On/Off
- 2 Manual boiler control whenever there is no Internet connection
- 3 Reset

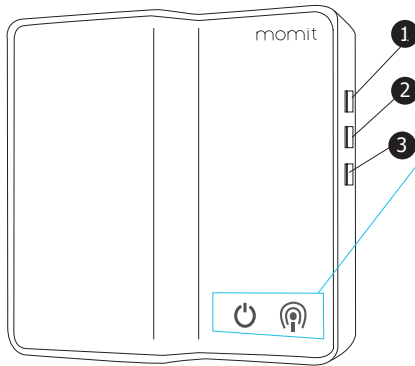

Status LEDs



⏻ Off

📶 Device connection indicator

The device connection LED 📶 will be on if everything is working properly. The Extension Kit is connected to Gateway as of that moment.

Customise your device

momit Home Thermostat has interchangeable frames. Follow these steps to change the frame:

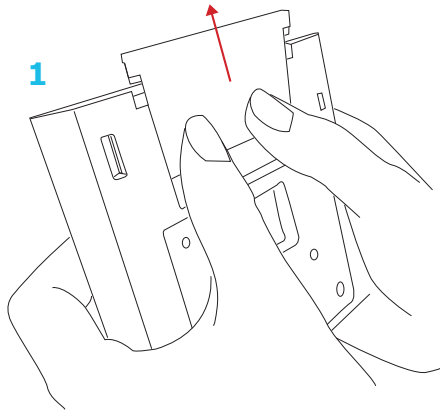

Remove the cover and take out the batteries.

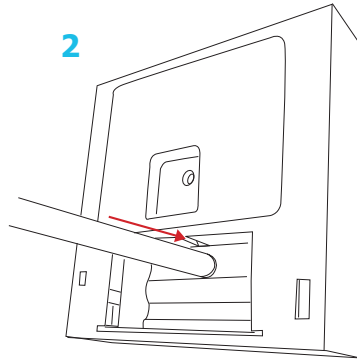

Insert a pen into the hole under the batteries.

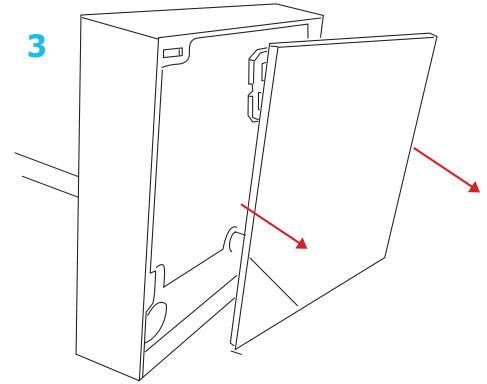

Exert pressure until the front casing comes away and pull it out.

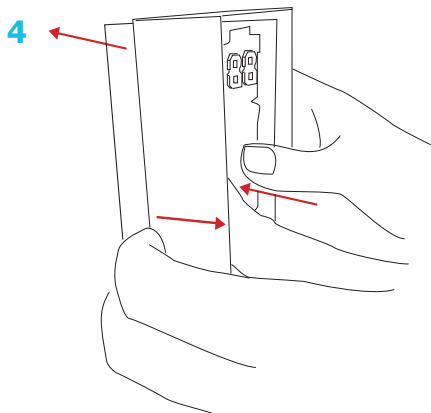

Press the body of the thermostat backwards while bringing the frame forward until it comes out.

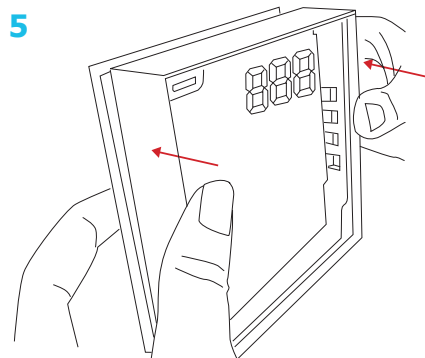

Position the new frame and, while in the same position as in the previous step, push the frame until it fits flush.

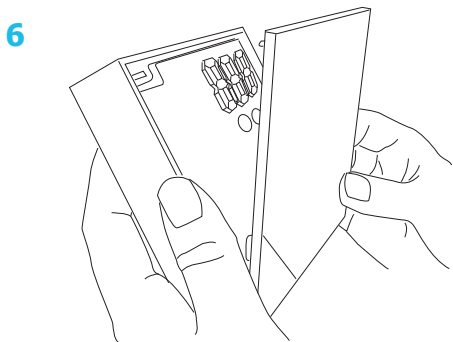

Put the front casing back by placing the bottom part as shown in the drawing.

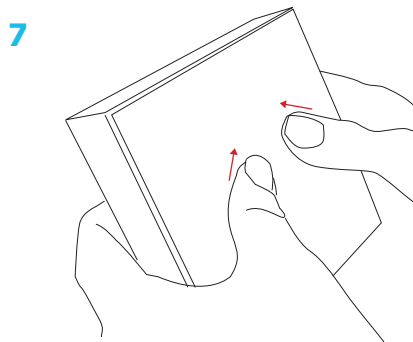

Push until it fits flush. Insert the batteries again and close the cover.

You can use momit Home over your smartphone, tablet or computer from the following URL:

<http://home.momit.com>

Download the momit App free of charge at:



To begin to use it, follow the instructions in the User Manual you can find on our web site:

www.momit.com

Customer services:

support@momit.com

CE Declaration of conformity

Green momit, S.L. hereby declares that these devices are in compliance with the basic requirements and other relevant provisions of Directive 1999/5/EC.

Safety Precautions

These devices must be installed in accordance with current regulations. Only use with the power socket adapter supplied. These devices are only for indoor use. Before inserting the batteries, check that the contacts in the devices and those on the batteries are clean. Where appropriate, clean them. Bear in mind (+/-) polarity when inserting the batteries. Do not throw the batteries into the fire. Do not short circuit them. Do not take them apart. Keep the batteries out of the reach of children. Get medical assistance immediately if a battery is swallowed. Do not try to repair devices yourself. There is a customer services department at your disposal. Any change or modification not expressly approved in this manual may annul user entitlement to the functioning and/or guarantee service for these devices. This device has not been designed for use by people (including children) with physical, sensorial or mental disabilities, or with a lack of experience and knowledge, unless a person responsible for their safety is watching them or provides them with instructions of how to use the devices. Children must be watched to make sure that they do not play with the devices.



momit[®]

Smart technology for everyone

Copyright Green momit[®] all rights reserved. Reproduction and distribution without the written permission of the company is prohibited.

