

### Features

- HSDIP20 package with the 4th Generation SiC-MOSFET
- $V_{DSS} = 750V$
- Low  $R_{DS(on)}$
- High-speed switching possible
- Low switching losses
- $T_{vjmax} = 175^{\circ}C$
- Compact design
- With high thermal conductivity isolation
- Integrated NTC temperature sensor
- 4.2kV AC 1s insulation
- Qualified according to AQG 324, release no.: 04.1/2025

### Construction

The power module is a full bridge module which implements SiC-MOSFETs.

### Application

- Automotive application
- Inverter, Converter
- (Hybrid) electrical vehicles EV/HEV

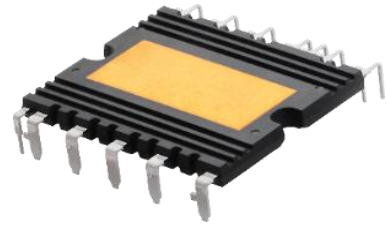

“EcoSiC™” is a trademark or a registered trademark of ROHM Co., Ltd.

### Outline

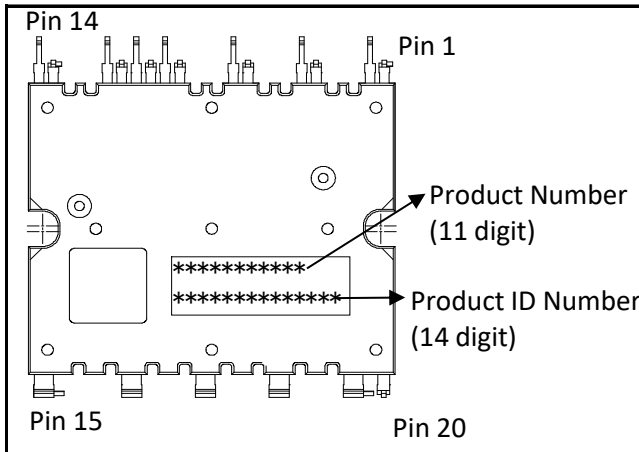

### Circuit diagram

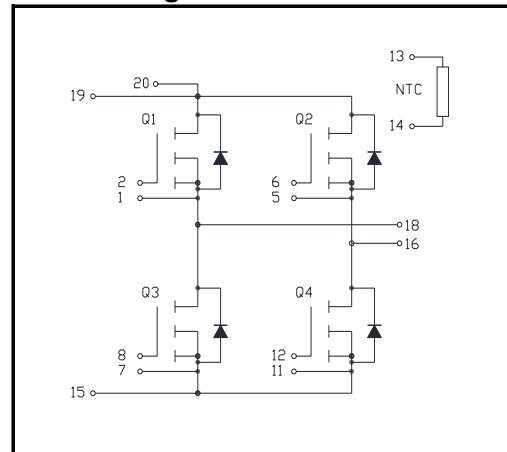

Pin No.	Pin Name	Function
1	S1	MOSFET Source
2	G1	MOSFET Gate
3	N.C	Non connect
4	N.C	Non connect
5	S2	MOSFET Source
6	G2	MOSFET Gate
7	S3	MOSFET Source
8	G3	MOSFET Gate
9	N.C	Non connect
10	N.C	Non connect

Pin No.	Pin Name	Function
11	S4	MOSFET Source
12	G4	MOSFET Gate
13	T1	Thermistor
14	T2	Thermistor
15	N	Negative power
16	W	Output
17	N.C	Non connect
18	U	Output
19	P	Positive Power
20	Ps	Positive Power sense

**Absolute maximum ratings (Tvj = 25°C unless otherwise specified)**

Parameter	Symbol	Conditions	Rating	Unit
Drain - source voltage	$V_{DSS}$	$V_{GS} = 0V$	750	V
Gate - source voltage (DC)	$V_{GSS}$		-4 to +21	
Gate - source voltage (t <sub>surge</sub> < 300ns)	$V_{GSSsurge}$		-4 to +23	
Continuous drain current (DC)	$I_D$	Tc = 25°C, V <sub>GS</sub> = 18V	91	A
		Tc = 100°C, V <sub>GS</sub> = 18V	64	
Pulsed drain current	$I_{D,pulse}$	Pulse 1ms, Tc = 25°C, V <sub>GS</sub> = 18V <sup>Note 2), 5)</sup>	195	
		Pulse 1ms, Tc = 100°C, V <sub>GS</sub> = 18V <sup>Note 2), 5)</sup>	138	
Continuous source current (DC)	$I_S$	Tc = 25°C, V <sub>GS</sub> = 18V	91	
Pulsed source current	$I_{S,pulse}$	Pulse 1.5µs, Tc = 25°C, V <sub>GS</sub> = 18V <sup>Note 2)</sup>	195	
Body diode pulsed forward current	$I_{S,pulse}$	Pulse 1.5µs, Tc = 25°C, V <sub>GS</sub> = 0V <sup>Note 2), 4), 5)</sup>	105	
Total power dissipation <sup>Note 3), 5)</sup>	P <sub>tot</sub>	Tc = 25°C	385	W
Virtual junction temperature	Tvj		-40 to +175	°C
Storage temperature	Tstg		-40 to +125	

- Note 1) If the product is used beyond absolute maximum ratings defined in the specifications, as its internal structure may be damaged, please replace the product with a new one.
- Note 2) Repetition rate should be kept within the range where temperature rise of die should not exceed Tvjmax.
- Note 3) Case temperature (Tc) is defined on the copper surface just under the chips.
- Note 4) Repetitive pulse, PW ≤ 1.5µs, Duty cycle ≤ 5%
- Note 5) Tvj is less than 175°C.

Figure 1. Example of acceptable V<sub>GS</sub> waveform

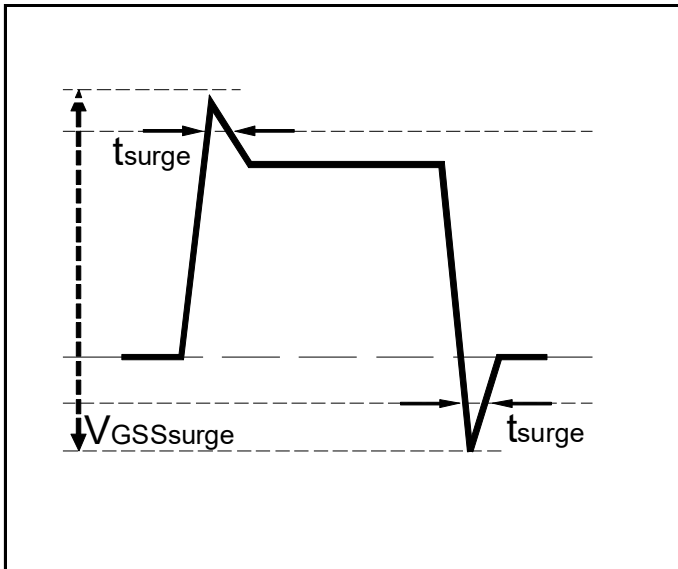
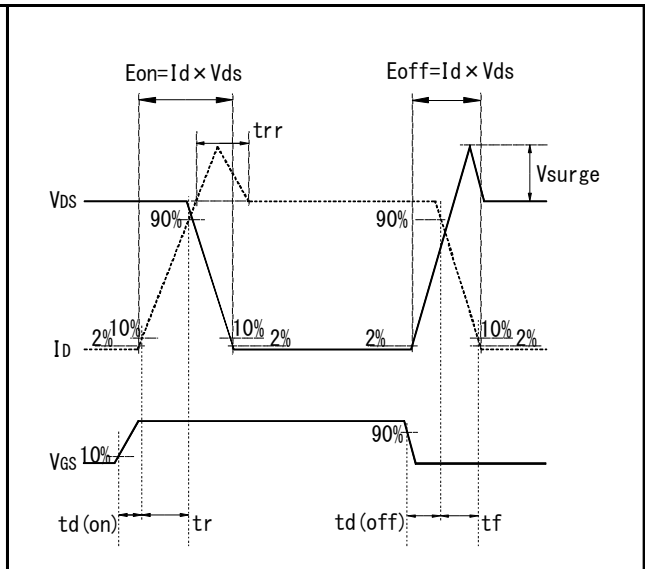

Figure 2. Wavelength for switching test



**Module (Tvj = 25°C unless otherwise specified)**

Parameter	Symbol	Conditions	Values			Unit
			Min.	Typ.	Max.	
Isolation test voltage	$V_{isol}$	All terminals to baseplate AC 60Hz 1sec.	4200	—	—	$V_{rms}$
Stray inductance	$L_s$	Terminal P to Terminal N	—	46	—	nH
Creepage distance	—	Terminal to heat sink	13.9	—	—	mm
		Terminal to terminal	8.2	—	—	
Clearance distance	—	Terminal to heat sink	10.2	—	—	mm
		Terminal to terminal	4.3	—	—	
Module flatness (Heatsink side)	—	Measurement point is shown in Figure 3.	0	—	100	$\mu m$
Mounting torque	—	Mounting to heatsink with M3 screw <sup>Note 6)</sup>	0.59	0.69	0.78	N·m
Terminal pulling strength	—	Load:4.9N(Control terminal), 9.8N(Power terminal) <sup>Note 7)</sup>	10	—	—	s
Terminal bending strength	—	Load:2.45N (Control terminal), 4.9N(Power terminal) <sup>Note7)</sup>	2	—	—	time
Thermal resistance, junction - case	$R_{th(j-c)}$	UMOSFET 1/4 module <sup>Note 8)</sup>	—	0.28	0.39	°C/W

Note 6) 8 mm (outside diameter) plain washers are recommended.

Note 7) EIAJ-ED-4701/400

Note 8)  $R_{th(j-c)}$  was measured after 1chip heating. Heatsink temperature was kept at 25°C.

The  $R_{th(j-c)}$  result was calculated from measured structure function, based on JESD51-14 guideline.

Note 9) When installing a module to a heat sink, excessive uneven fastening force might apply stress to inside chips or ceramic of heat sink plate, which will break or crack or degrade a module.

An example of recommended fastening sequence is shown in Figure 5. The temporary fastening torque is set to 20 to 30% of the maximum torque rating.

Figure 3. Measurement point of module flatness

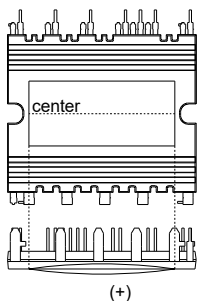

Figure 4. Flatness after installing to a heatsink (when using a heat radiation sheet)

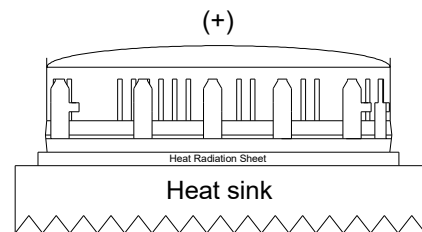
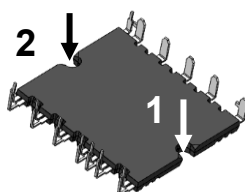

Figure 5. Example of recommended fastening sequence



Temporary fastening: 1→2

Permanent fastening: 1→2

**MOSFET electrical characteristics (Tvj = 25°C unless otherwise specified)**

Parameter	Symbol	Conditions	Values			Unit	
			Min.	Typ.	Max.		
Drain - source on resistance	R <sub>DS(on)</sub>	I <sub>D</sub> = 58A, V <sub>GS</sub> = 18V	Tvj = 25°C	—	13	—	mΩ
		I <sub>D</sub> = 91A, V <sub>GS</sub> = 18V	Tvj = 25°C	—	14	19	
			Tvj = 175°C	—	27	—	
Zero gate voltage drain current	I <sub>DSS</sub>	V <sub>DS</sub> = 750V, V <sub>GS</sub> = 0V		—	—	80	μA
Drain-Source breakdown voltage	V <sub>(BR)DSS</sub>	V <sub>GS</sub> = 0V, I <sub>D</sub> = 18.6mA, Tvj = 25°C		750	—	—	V
Gate - source threshold voltage	V <sub>GS(th)</sub>	V <sub>DS</sub> = 10V, I <sub>D</sub> = 30.8mA <sup>Note 12)</sup>		2.8	—	4.8	V
Gate - source leakage current	I <sub>GSS</sub>	V <sub>GS</sub> = +21V, V <sub>DS</sub> = 0V		—	—	0.1	μA
		V <sub>GS</sub> = -4V, V <sub>DS</sub> = 0V		-0.1	—	—	
Turn - on delay time	t <sub>d(on)</sub>	V <sub>GS(on)</sub> = 18V, V <sub>GS(off)</sub> = 0V V <sub>DS</sub> = 400V I <sub>D</sub> = 90A R <sub>G(on)</sub> = 18Ω, R <sub>G(off)</sub> = 18Ω Inductive load		—	49.3	—	ns
Rise time	t <sub>r</sub>			—	39.3	—	
Turn - off delay time	t <sub>d(off)</sub>			—	213.2	—	
Fall time	t <sub>f</sub>			—	14.2	—	
Turn - on switching loss	E <sub>on</sub>			—	1.61	—	
Turn - off switching loss	E <sub>off</sub>		—	1.79	—		
Input capacitance	C <sub>iss</sub>	V <sub>DS</sub> = 500V, V <sub>GS</sub> = 0V, 1MHz		—	4.58	—	nF
Total gate charge	Q <sub>g</sub>	V <sub>GS(on)</sub> = 18V, V <sub>GS(off)</sub> = 0V V <sub>DS</sub> = 500V I <sub>D</sub> = 58A		—	170	—	nC
Gate - source charge	Q <sub>gs</sub>			—	39	—	
Gate - drain charge	Q <sub>gd</sub>			—	42	—	
Internal gate resistance	R <sub>Gint</sub>	Tvj = 25°C		—	1	—	Ω

Note 10) Evenly apply thermally-conductive grease with 100μm to 200μm thickness over the contact surface between the module and the heat sink. Pay attention not to have any dirt left on the contact surface between the module and the heat sink.

It is recommended to install a module directly to a heat sink after applying grease.

Note 11) When installing a module to a heat sink, inserting a heat radiation sheet between a module and a heat sink might apply stress depending on thickness and elastic modulus of the sheet to inside chips or ceramic of heat sink plate, which will break or crack or degrade a module.

When using a heat radiation sheet, it is needed to prevent power module from bending into + side of Figure 4.

Note 12) Tested after applying V<sub>GS</sub> = 21V for 100ms.

Note 13) SiC devices have lower short circuit withstand capability due to high current density.

Please be advised to pay careful attention to short circuit accident and try to adjust protection time to shutdown them as short as possible.

**Body diode electrical characteristics (T<sub>vj</sub> = 25°C unless otherwise specified)**

Parameter	Symbol	Conditions	Values			Unit	
			Min.	Typ.	Max.		
Source - drain voltage	V <sub>SD</sub>	V <sub>GS</sub> = 0V, I <sub>S</sub> = 91A	T <sub>vj</sub> = 25°C	—	3.9	—	V
			T <sub>vj</sub> = 175°C	—	4.0	—	
		V <sub>GS</sub> = 18V, I <sub>S</sub> = 91A	T <sub>vj</sub> = 25°C	—	1.15	—	
			T <sub>vj</sub> = 175°C	—	2.03	—	

**NTC Thermistor electrical characteristics (T<sub>vj</sub> = 25°C unless otherwise specified)**

Parameter	Symbol	Conditions	Values			Unit
			Min.	Typ.	Max.	
NTC rated resistance	R <sub>25</sub>	T <sub>c</sub> = 25°C	—	10	—	kΩ
NTC B Value	B <sub>50/25</sub>		—	3380	—	K
Maximum operating current	—		—	—	0.1	mA

Electrical characteristic curves (Typical)

Figure 6. Output characteristic at 25°C (Typ.)

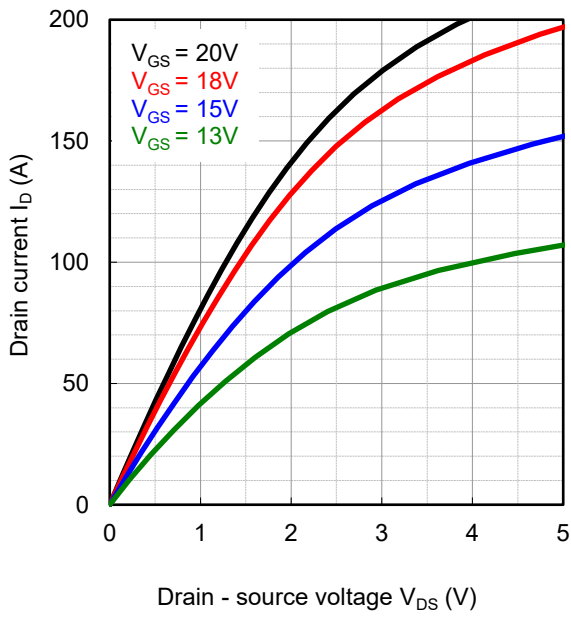

Figure 7. Drain - source voltage characteristic (Typ.)

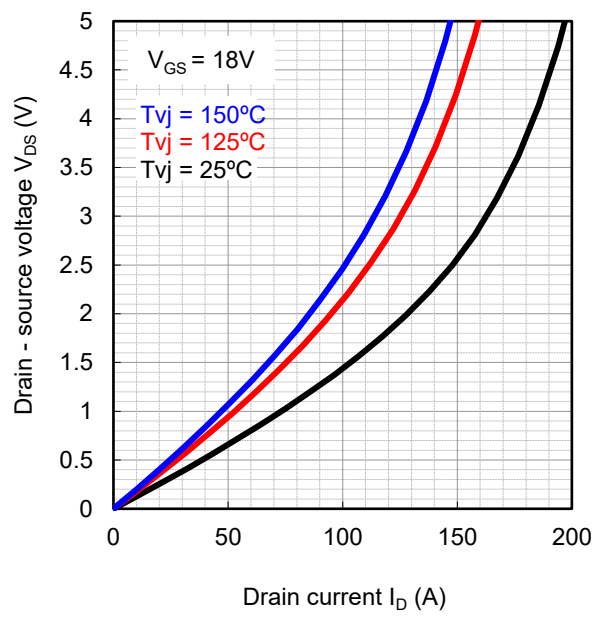
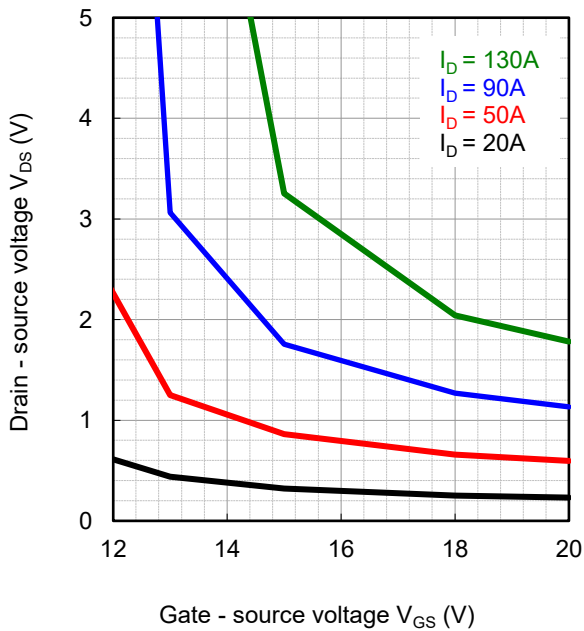

Figure 8. Drain - source voltage characteristic at 25°C (Typ.)



Electrical characteristic curves (Typical)

Figure 9.  $R_{DS(on)}$  vs.  $T_{vj}$  characteristic (Typ.)

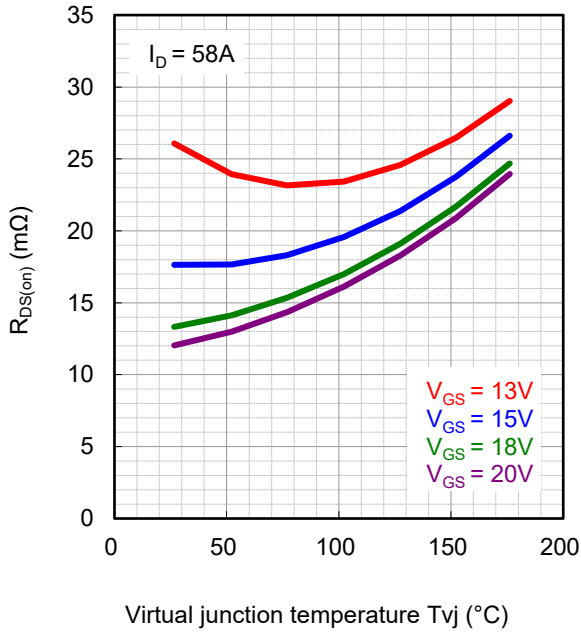

Figure 10. Forward characteristic of diode  $V_{GS} = 18V$  (Typ.)

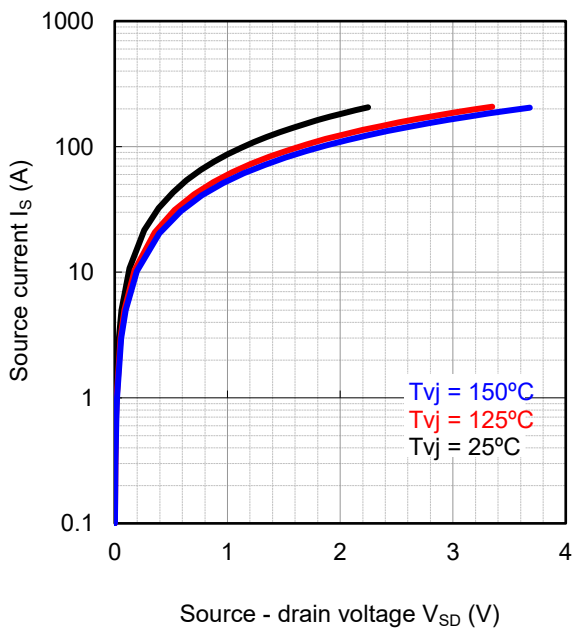
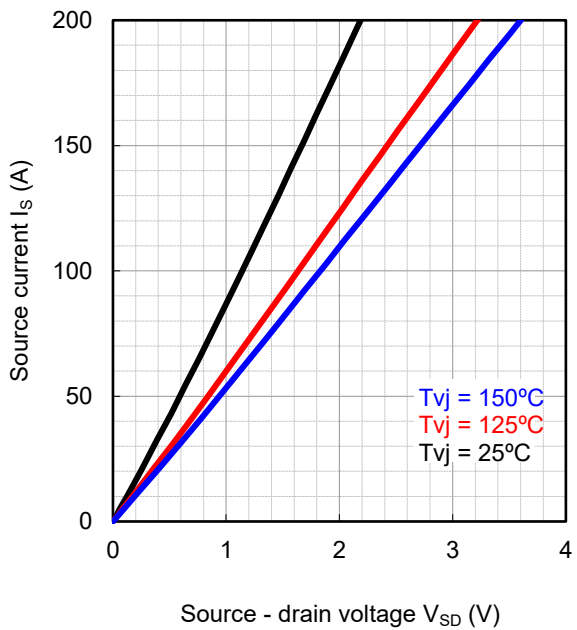

Figure 11. Forward characteristic of diode  $V_{GS} = 18V$  (Typ.)



Electrical characteristic curves (Typical)

Figure 12. Forward characteristic of diode  
 $V_{GS} = 0V$  (Typ.)

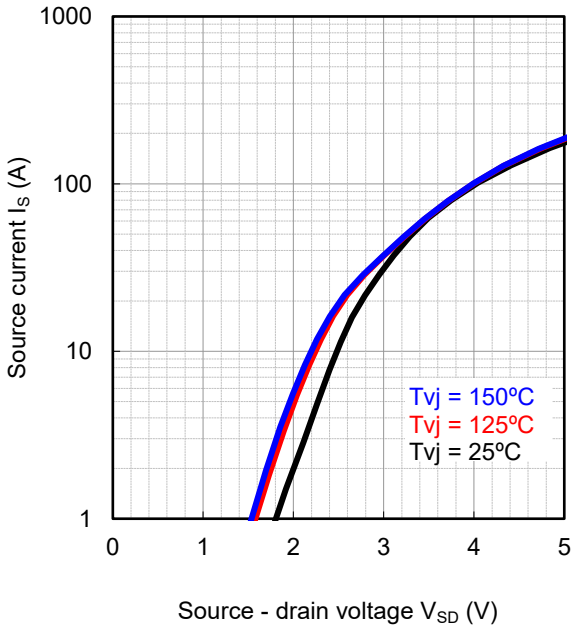

Figure 13. Forward characteristic of diode  
 $V_{GS} = 0V$  (Typ.)

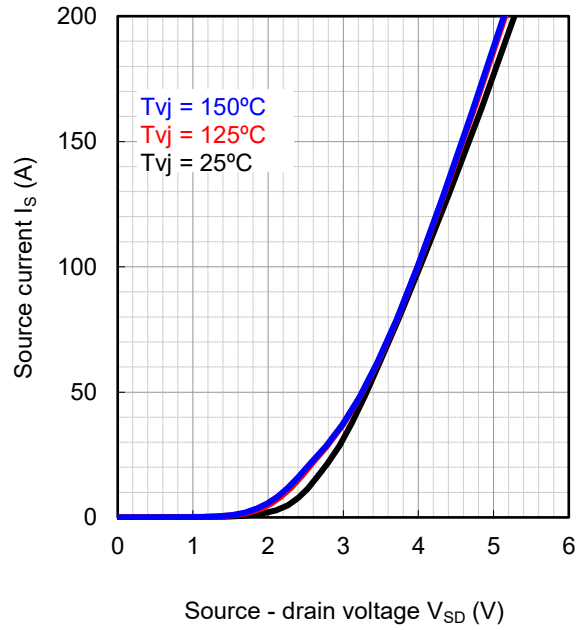

Figure 14. Drain current vs. Gate-source voltage (Typ.)

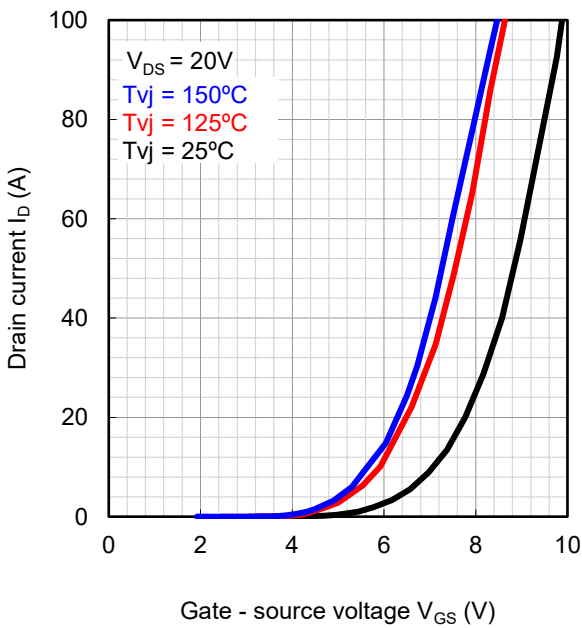
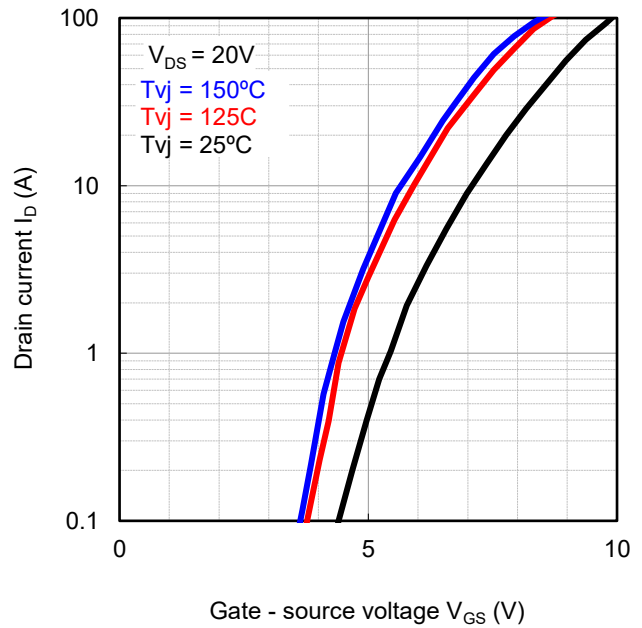

Figure 15. Drain current vs. Gate-source voltage (Typ.)



Electrical characteristic curves (Typical)

Figure 16. Switching time vs. Drain current at 25°C (Typ.)

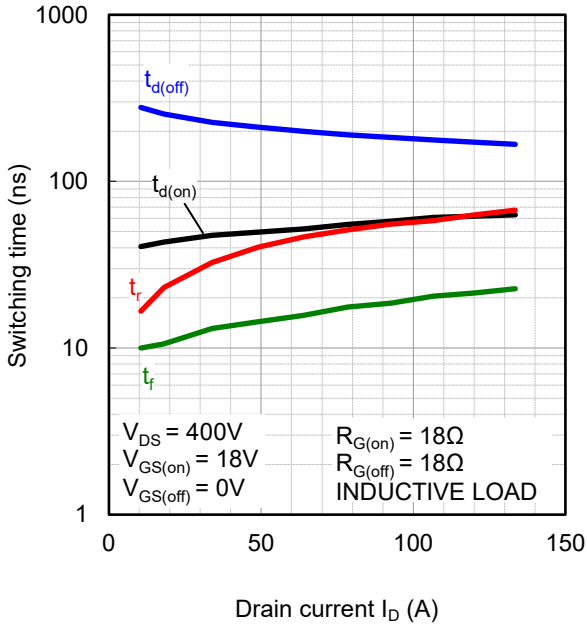

Figure 17. Switching time vs. Drain current at 150°C (Typ.)

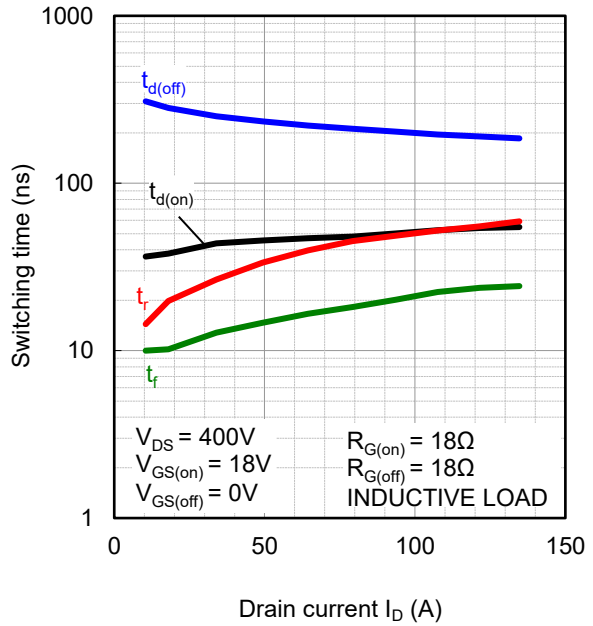

Figure 18. Switching loss vs. Drain current at 25°C (Typ.)

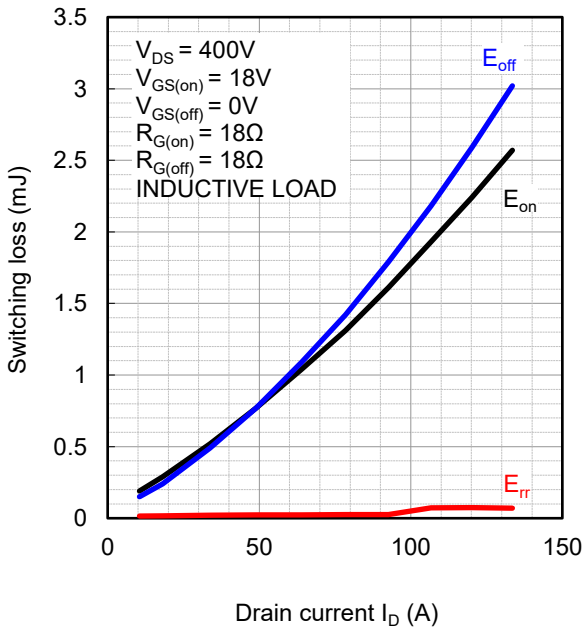
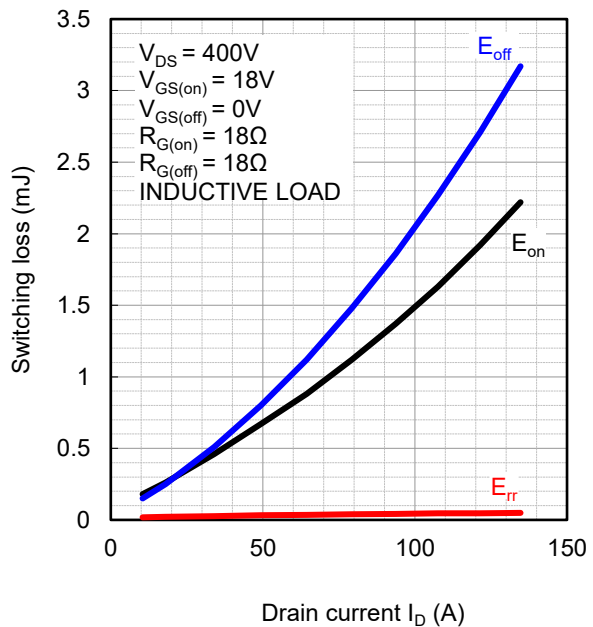

Figure 19. Switching loss vs. Drain current at 150°C (Typ.)



Electrical characteristic curves (Typical)

Figure 20. Recovery characteristic vs. Drain current at 25°C (Typ.)

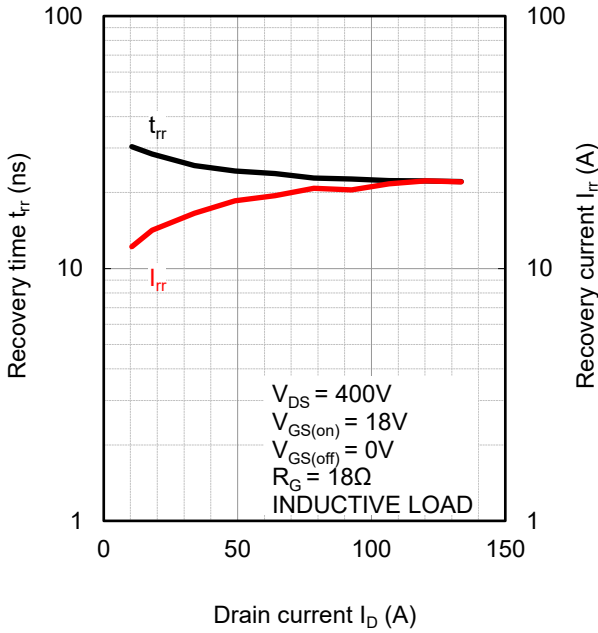

Figure 21. Recovery characteristic vs. Drain current at 150°C (Typ.)

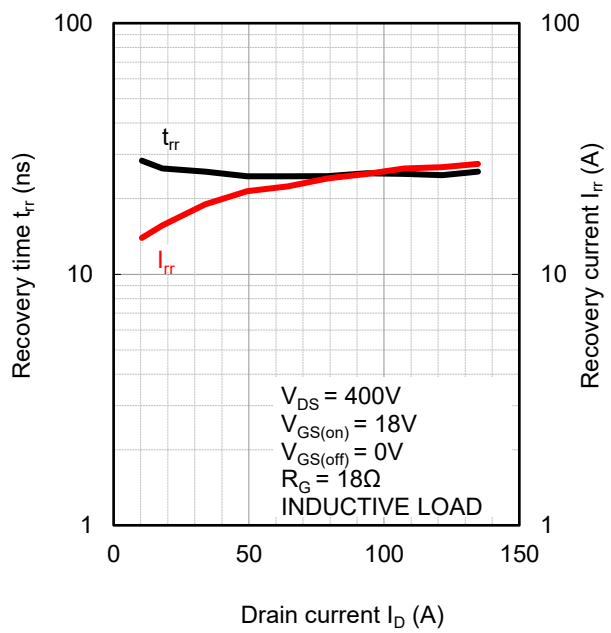

Figure 22. Switching time vs. Gate resistance at 25°C (Typ.)

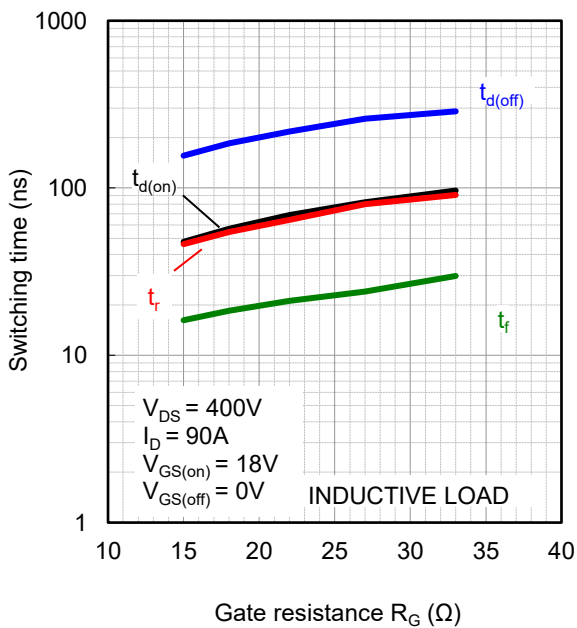
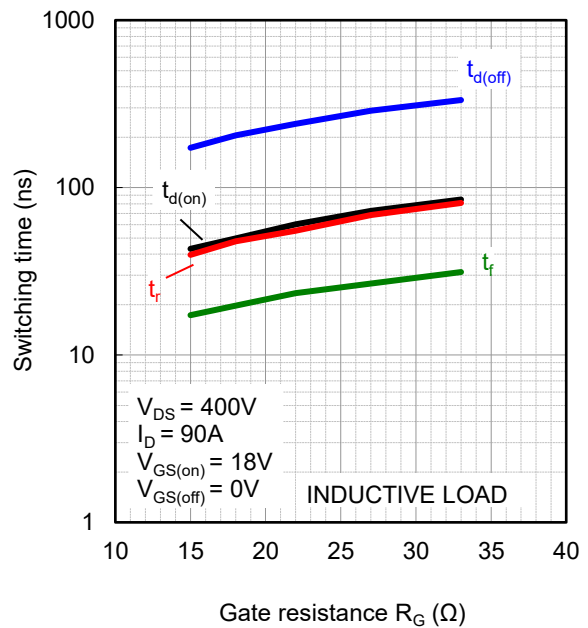

Figure 23. Switching time vs. Gate resistance at 150°C (Typ.)



Electrical characteristic curves (Typical)

Figure 24. Switching loss vs. Gate resistance at 25°C (Typ.)

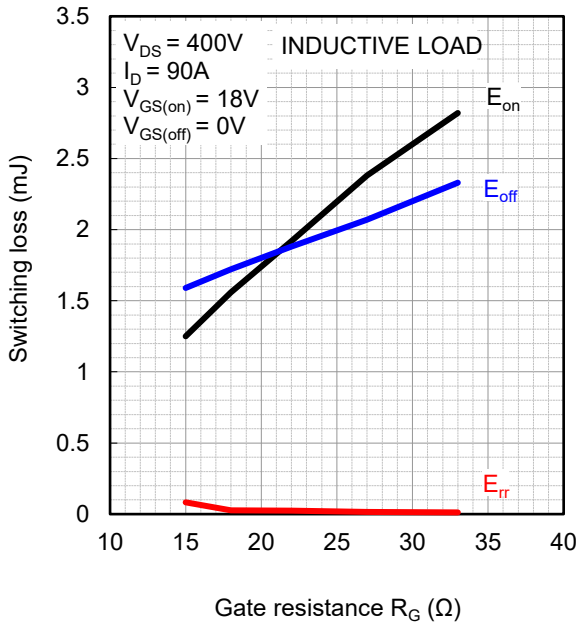

Figure 25. Switching loss vs. Gate resistance at 150°C (Typ.)

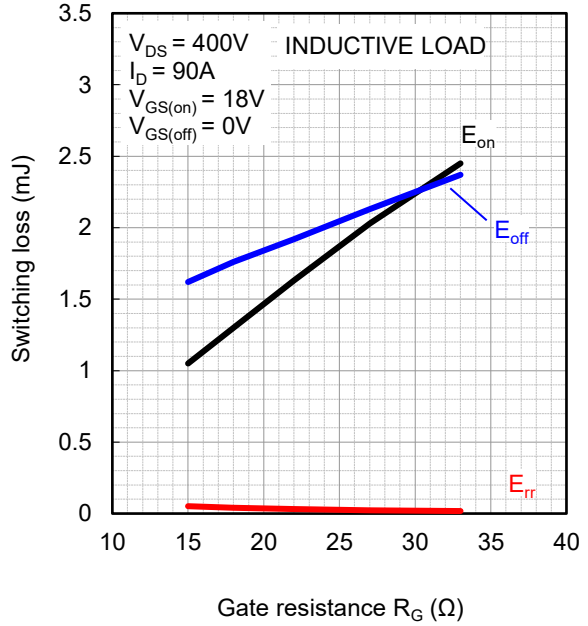

Figure 26. Capacitance vs. Drain - source voltage at 25°C (Typ.)

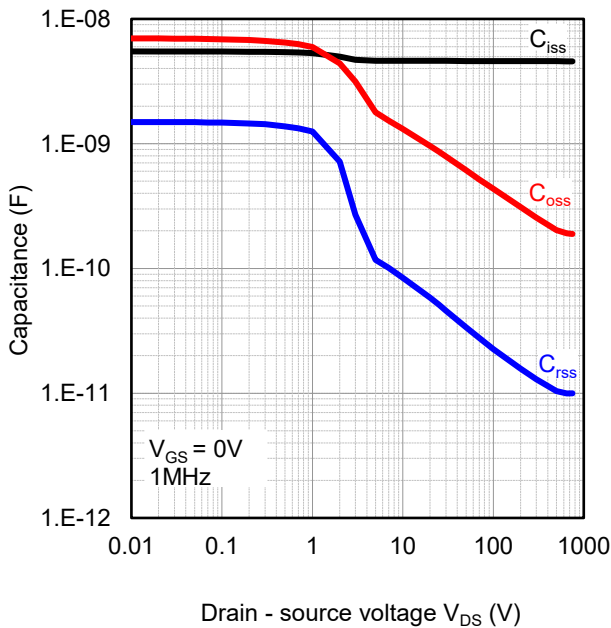
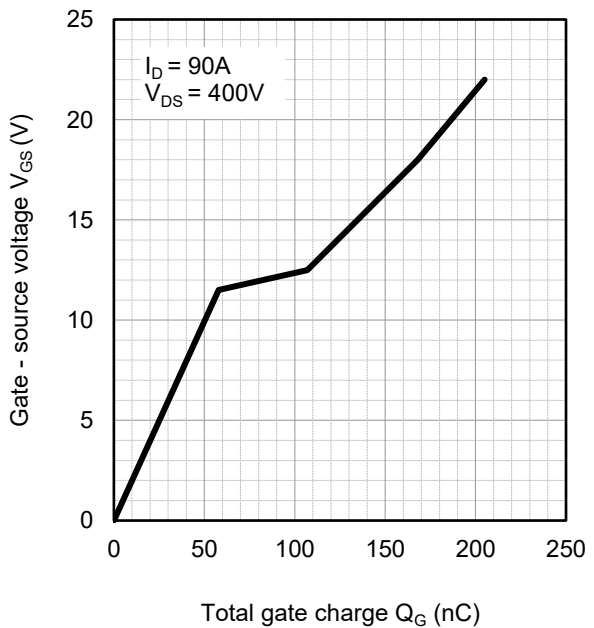
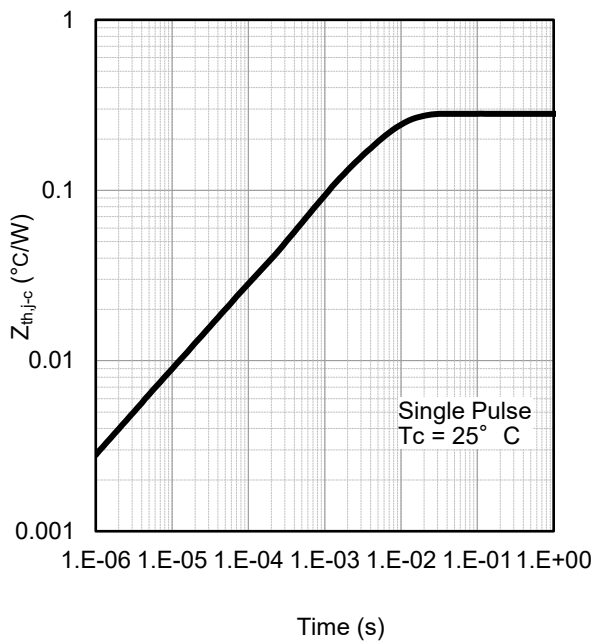

Figure 27. Gate charge characteristic at 25°C (Typ.)



Electrical characteristic curves (Typical)

Figure 28. Transient thermal impedance (Typ.)



Package outlines

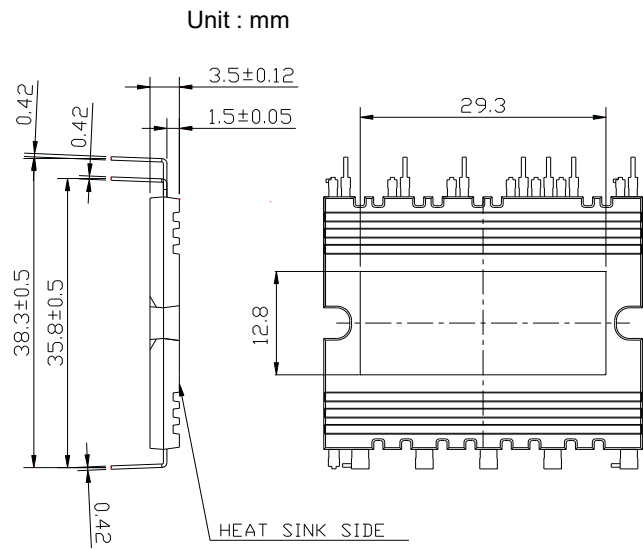
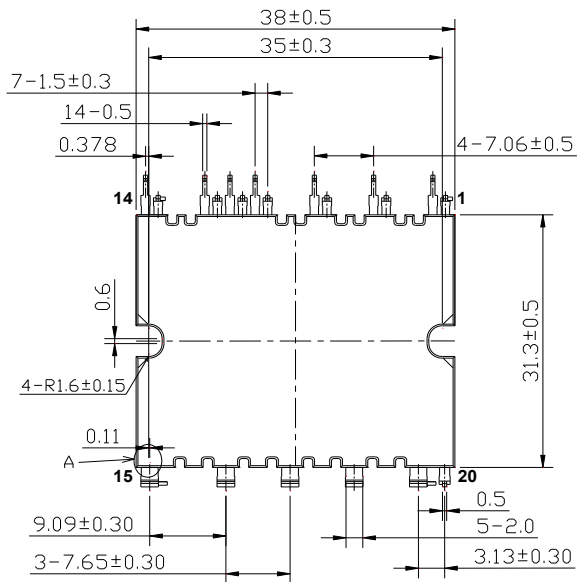

Unit : mm

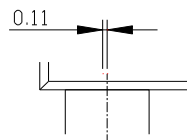
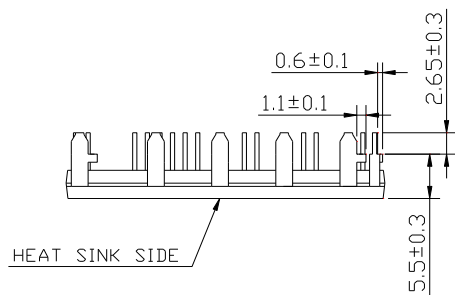

DETAIL A (5/1)

## Notes

- 1) The information contained herein is subject to change without notice.
- 2) Before you use our Products, please contact our sales representative and verify the latest specifications.
- 3) Although ROHM is continuously working to improve product reliability and quality, semiconductors can break down and malfunction due to various factors. Therefore, in order to prevent personal injury or fire arising from failure, please take safety measures such as complying with the derating characteristics, implementing redundant and fire prevention designs, and utilizing backups and fail-safe procedures. ROHM shall have no responsibility for any damages arising out of the use of our Products beyond the rating specified by ROHM.
- 4) Examples of application circuits, circuit constants and any other information contained herein are provided only to illustrate the standard usage and operations of the Products. The peripheral conditions must be taken into account when designing circuits for mass production.
- 5) The technical information specified herein is intended only to show the typical functions of and examples of application circuits for the Products. ROHM does not grant you, explicitly or implicitly, any license to use or exercise intellectual property or other rights held by ROHM or any other parties. ROHM shall have no responsibility whatsoever for any dispute arising out of the use of such technical information.
- 6) The Products specified in this document are not designed to be radiation tolerant.
- 7) For use of our Products in applications requiring a high degree of reliability (as exemplified below), please contact and consult with a ROHM representative : transportation equipment (i.e. cars, ships, trains), primary communication equipment, traffic lights, fire/crime prevention, safety equipment, medical systems, and power transmission systems.
- 8) Do not use our Products in applications requiring extremely high reliability, such as aerospace equipment, nuclear power control systems, and submarine repeaters.
- 9) ROHM shall have no responsibility for any damages or injury arising from non-compliance with the recommended usage conditions and specifications contained herein.
- 10) ROHM has used reasonable care to ensure the accuracy of the information contained in this document. However, ROHM does not warrants that such information is error-free, and ROHM shall have no responsibility for any damages arising from any inaccuracy or misprint of such information.
- 11) Please use the Products in accordance with any applicable environmental laws and regulations, such as the RoHS Directive. For more details, including RoHS compatibility, please contact a ROHM sales office. ROHM shall have no responsibility for any damages or losses resulting non-compliance with any applicable laws or regulations.
- 12) When providing our Products and technologies contained in this document to other countries, you must abide by the procedures and provisions stipulated in all applicable export laws and regulations, including without limitation the US Export Administration Regulations and the Foreign Exchange and Foreign Trade Act.
- 13) This document, in part or in whole, may not be reprinted or reproduced without prior consent of ROHM.



Thank you for your accessing to ROHM product informations.  
More detail product informations and catalogs are available, please contact us.

## ROHM Customer Support System

<http://www.rohm.com/contact/>

**General Precaution**

1. Before you use our Products, you are requested to carefully read this document and fully understand its contents. ROHM shall not be in any way responsible or liable for failure, malfunction or accident arising from the use of any ROHM's Products against warning, caution or note contained in this document.
2. All information contained in this document is current as of the issuing date and subject to change without any prior notice. Before purchasing or using ROHM's Products, please confirm the latest information with a ROHM sales representative.
3. The information contained in this document is provided on an "as is" basis and ROHM does not warrant that all information contained in this document is accurate and/or error-free. ROHM shall not be in any way responsible or liable for any damages, expenses or losses incurred by you or third parties resulting from inaccuracy or errors of or concerning such information.