

|     |             |             |
|-----|-------------|-------------|
| REV | Description | Date        |
| A00 | First Issue | 2015-MAY-20 |

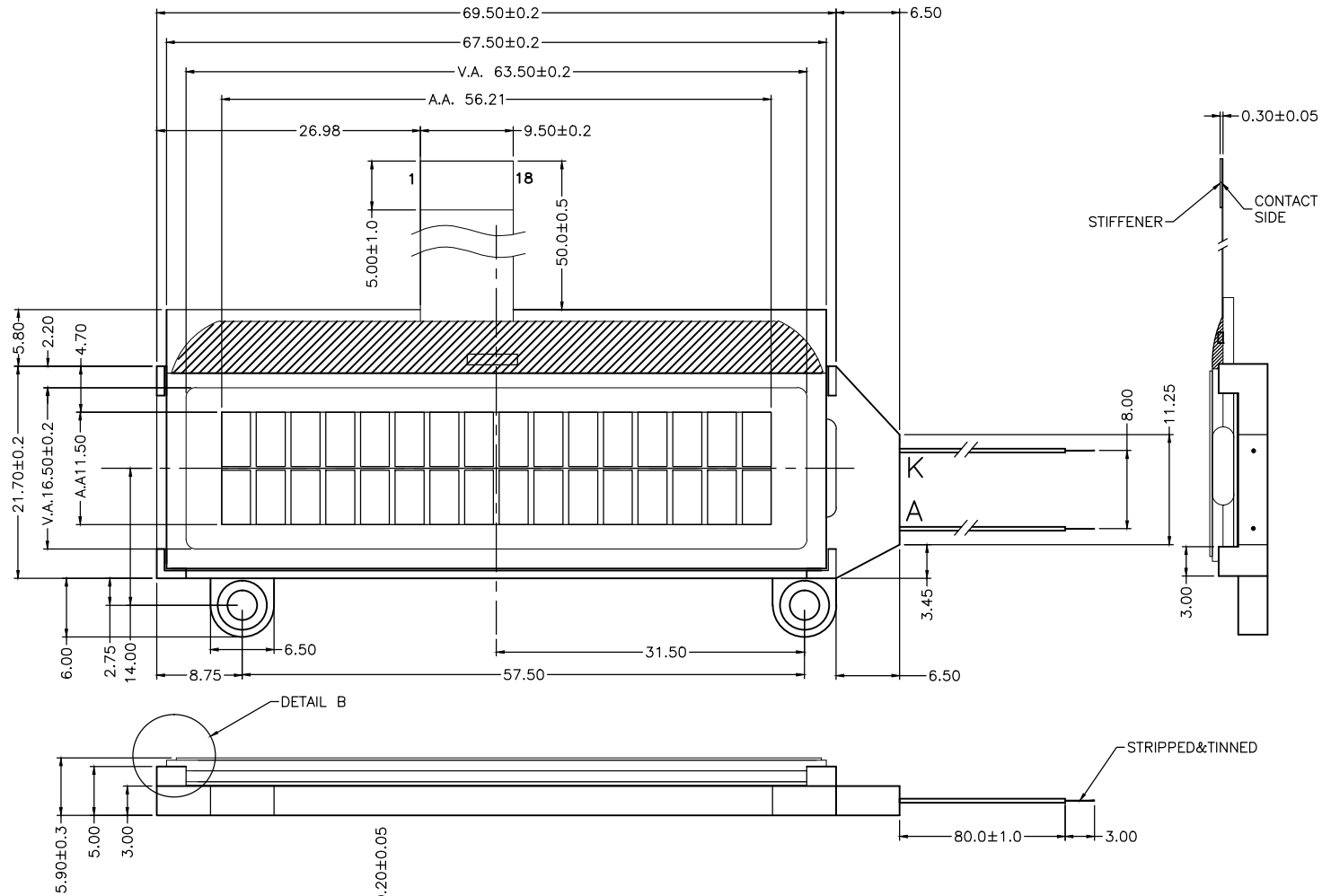

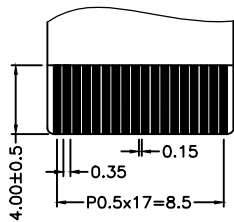
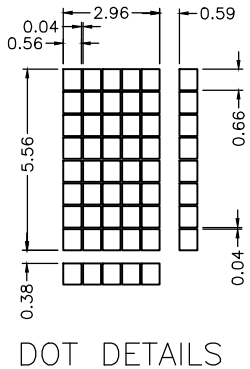
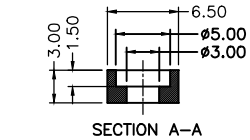

PIN ASSIGNMENT:

|    |      |
|----|------|
| 1  | RSTB |
| 2  | A0   |
| 3  | CSB  |
| 4  | RW   |
| 5  | E    |
| 6  | DB0  |
| 7  | DB1  |
| 8  | DB2  |
| 9  | DB3  |
| 10 | DB4  |
| 11 | DB5  |
| 12 | DB6  |
| 13 | DB7  |
| 14 | VSS  |
| 15 | VDD  |
| 16 | VG   |
| 17 | V0   |
| 18 | XV0  |
| A  | LED+ |
| K  | LED- |

SPECIFICATIONS:

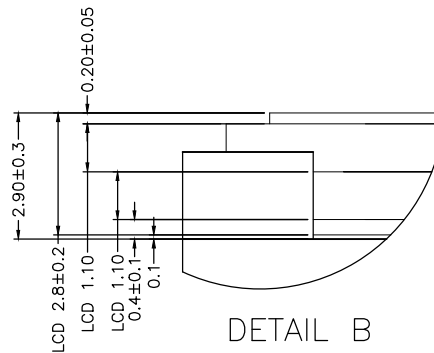
- 1) FSTN/-VE/TRANSMISSIVE MODE
- 2) 1/16 DUTY, 1/5 BIAS, VLCD=4.5V
- 3) VIEWING ANGLE=12 O'CLOCK
- 4) OP.TEMP.= -20 °C TO °C+70  
ST.TEMP.= -30 °C TO °C+80
- 5) WITH WHITE LED BACKLIGHT, 3.3V@15mA
- 6) DRIVER: ST7032S, VDD=2.7 ~ 3.45V

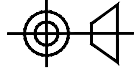

|   |  |
|---|--|
| Description: <b>MECHANICAL SPECIFICATIONS</b>   |  |
| Scale:  |  <b>TRI-T COMPANY LIMITED</b> |
| Sheet : 1 of 1  |  |
| Unspecified Tol. ±0.3   | Unit mm  |
| Approvals   | Date   |
| Draw:   | Project Number<br>CI064-4001-32  |
| Check:  | Item Number  |
| Approve:  | Do Not Scale This Drawing  |
| <br>Projection |  |