

- CYLINDRICAL V-CHIP CONSTRUCTION FOR SURFACE MOUNTING
- EXTENDED LOAD LIFE AT HIGH TEMPERATURE (5000 ~ 10,000 HOURS @ +105°C)
- HIGH VOLTAGE RATINGS (25 ~ 100VDC)
- LOW ESR AND HIGH RIPPLE CURRENT RATINGS
- 6.3x8mm ~ 10x10.8mm CASE SIZES
- REFLOW SOLDERING RATED TO +260°C (ALL SIZES)

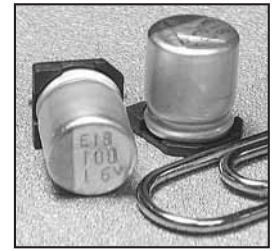

**RoHS
Compliant**

includes all homogeneous materials

*See Part Number System for Details

CHARACTERISTICS

Rated Voltage Range	25 ~ 100Vdc		
Rated Capacitance Range	2.7 ~ 270μF		
Operating Temp. Range	-55 ~ +105°C		
Capacitance Tolerance	±20% (M)		
Max. Leakage Current After 2 Minutes @ 20°C	Less than 0.05CV or 100μA whichever is greater		
Working and Surge Voltage Ratings	W.V. (Vdc)	25 35 40 50 63 80 100	
	S.V. (Vdc)	32 44 50 63 79 100 125	
Tan δ @ 120Hz/20°C		0.16	
Impedance Ratio	Z -55°C/Z +20°C	1 ~ 2.5	
	Z +105°C/Z +20°C	0.6 ~ 1.0	
Load Life Test @ 105°C and Rated Voltage	W.V. (Vdc)	25 35 40 50 63 80 100	
	Case Dia.	φ6.3mm	5000 hrs.
		φ8 & 10mm	10000 hrs.
	Capacitance Change	Within ±30% of initial measured value	
	Tan δ and ESR	Less than 200% of specified max. value	
	Leakage Current	Less than specified max. value	
ESR	Less than 200% of specified max. value		

STANDARD PRODUCTS AND CASE SIZES Dφ x L (mm)

PART NUMBER	Cap. (μF)	Working Voltage	Case Size (D X L) mm	Max. Tan δ 120Hz/20°C	Max. ESR (mΩ) AT 100KHz/20°C	Max. Ripple Current (mA rms) AT 100KHz/105°C	Load Life Hours (+105°C)
NSPE-H470M25V6.3X6.3NBYF	47	25	6.3X6.3	0.16	60	1270	5000
NSPE-H680M25V6.3X8NBYF	68		6.3X8	0.16	45	1400	5000
NSPE-H151M25V8X10.8NBYF	150		8X10.8	0.16	27	1900	7000
NSPE-H271M25V10X10.8NBYF	270		10X10.8	0.16	22	2530	7000
NSPE-H270M35V6.3X6.3NBYF	27	35	6.3X6.3	0.16	100	1080	5000
NSPE-H470M35V6.3X8NBYF	47		6.3X8	0.16	60	1300	5000
NSPE-H101M35V8X10.8NBYF	100		8X10.8	0.16	30	1800	10000
NSPE-H151M35V10X10.8NBYF	150		10X10.8	0.16	23	2470	10000
NSPE-H180M40V6.3X6.3NBYF	18	40	6.3X6.3	0.16	110	1030	5000
NSPE-H270M40V6.3X8NBYF	27		6.3X8	0.16	70	1250	5000
NSPE-H560M40V8X10.8NBYF	56		8X10.8	0.16	32	1750	10000
NSPE-H101M40V10X10.8NBYF	100		10X10.8	0.16	24	2400	10000
NSPE-H5R6M50V6.3X6.3NBYF	5.6	50	6.3X6.3	0.16	120	980	5000
NSPE-H100M50V6.3X8NBYF	10		6.3X8	0.16	80	1200	5000
NSPE-H330M50V8X10.8NBYF	33		8X10.8	0.16	35	1670	10000
NSPE-H560M50V10X10.8NBYF	56		10X10.8	0.16	25	2320	10000
NSPE-H2R7M63V6.3X6.3NBYF	2.7	63	6.3X6.3	0.16	150	960	5000
NSPE-H3R9M63V6.3X8NBYF	3.9		6.3X8	0.16	100	1060	5000
NSPE-H220M63V8X10.8NBYF	22		8X10.8	0.16	40	1560	10000
NSPE-H330M63V10X10.8NBYF	33		10X10.8	0.16	30	2100	10000
NSPE-H120M80V10X10.8LBYF	12	80	10X10.8	0.16	70	1600	10000
NSPE-H100M100V10X10.8LBYF	10	100	10X10.8	0.16	80	1450	10000

PRECAUTIONS

Please review the notes on correct use, safety and precautions found on pages T10 & T11 of NIC's Electrolytic Capacitor catalog.

Also found at www.niccomp.com/precautions

If in doubt or uncertainty, please review your specific application - process details with NIC's technical support personnel: tpmg@niccomp.com

RIPPLE CURRENT FREQUENCY CORRECTION FACTORS

Cap. μF	100Hz	1KHz	10KHz	100KHz
$C \leq 4.7$	0.03	0.30	0.65	1.00
5.6 ~ 33	0.05	0.32	0.67	1.00
> 33	0.10	0.35	0.70	1.00

PART NUMBER SYSTEM

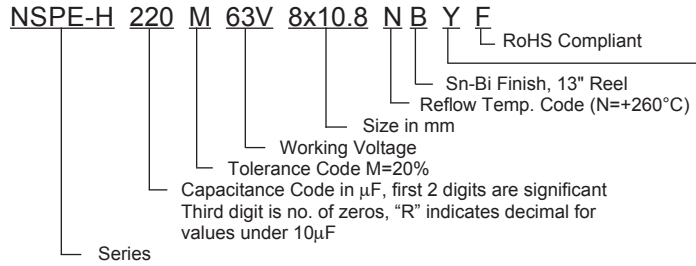

Suitable for automotive equipment, sourced to special production and inspection at TS-16949 certified production site

DIMENSIONS (mm)

Case Size	$D\phi \pm 0.5$	L max.	A, B ± 0.2	W	I ± 0.2	P ± 0.2
6.3X6.3	6.3	6.3	6.6	0.5 ~ 0.8	2.5	2.2
6.3x8	6.3	8.0	6.6	0.5 ~ 0.8	2.5	2.2
8x10.8	8.0	10.8	8.3	0.7 ~ 1.0	2.9	3.2
10x10.8	10	10.8	10.3	1.0 ~ 1.4	3.2	4.6

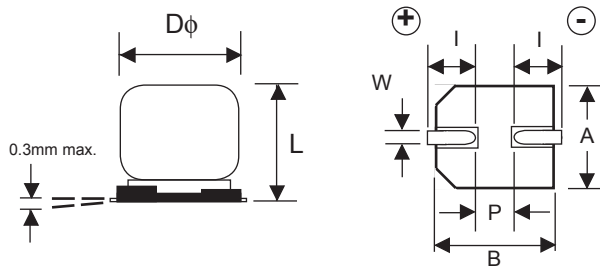

Part Marking

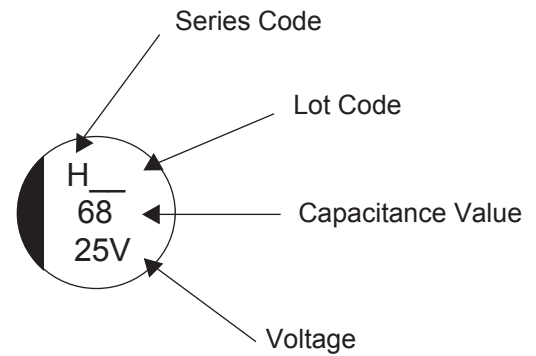

RECOMMENDED REFLOW SOLDERING PROFILE*

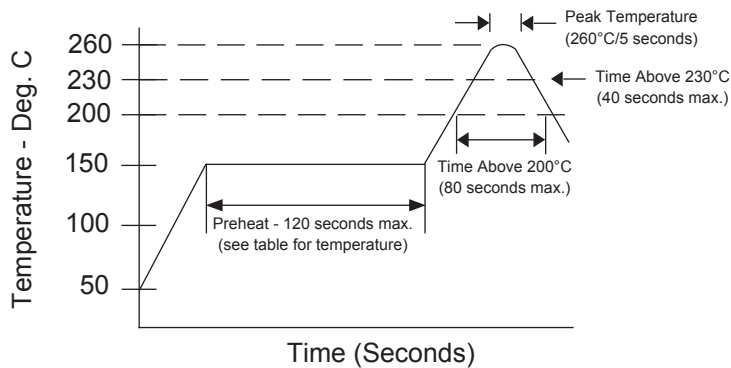

LAND PATTERN DIM. (mm)

Case Dia.	A	B	P
6.3	3.5	1.8	2.1
8	4.1	2.1	2.8
10	4.4	2.5	4.3

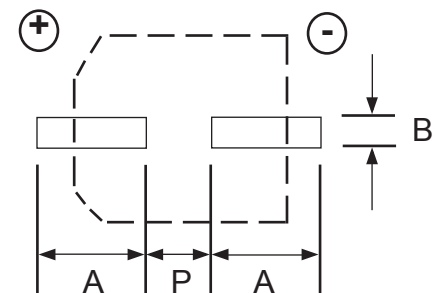

PEAK TEMPERATURE AND DURATION

Diameter	Preheat (120 sec. max.)	Time above 200°C	Time above 230°C	Peak Temperature
6.3 ~ 10mm	150°C ~ 190°C	80 sec. max.	40 sec. max.	260°C/5 sec.

*Two reflow passes are permissible with a cool down to room temperature required between the first and second pass.

TAPING SPECIFICATIONS (mm)

- Both Leader and Trailer tape: Minimum 40mm (1.57") empty carrier tape pockets.
- Leader tape: Approximately 20cm of cover tape at leader.
- Connection: Maximum 3 connections (slices) per reel.

Case Size	A ±0.5	B ±0.5	C ±0.3	D ±0.1	P ±0.1	T ±0.2	t max.
6.3x6.3	7.0	7.0	16.0	7.5	12.0	6.5	0.6
6.3x8	7.0	7.0	16.0	7.5	12.0	8.2	0.6
8x10.8	8.7	8.7	24.0	11.5	16.0	11.0	0.6
10x10.8	10.7	10.7	24.0	11.5	16.0	11.0	0.6

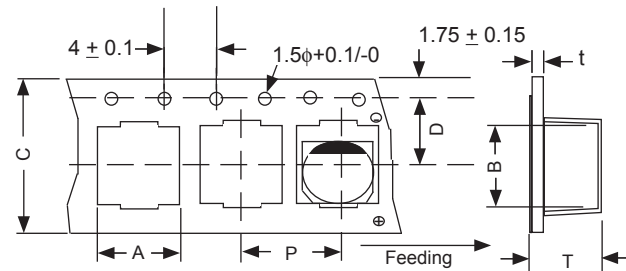

REEL DIMENSIONS (mm)

Case Size	W ±1.0	Qty per Reel 13" (330mm)
6.3x6.3	18	800
6.3x8	18	500
8x10.8	26	300
10x10.8	26	300

