

CHROME

BUSSOLE E ACCESSORI CHROME
CHROME sockets and accessories

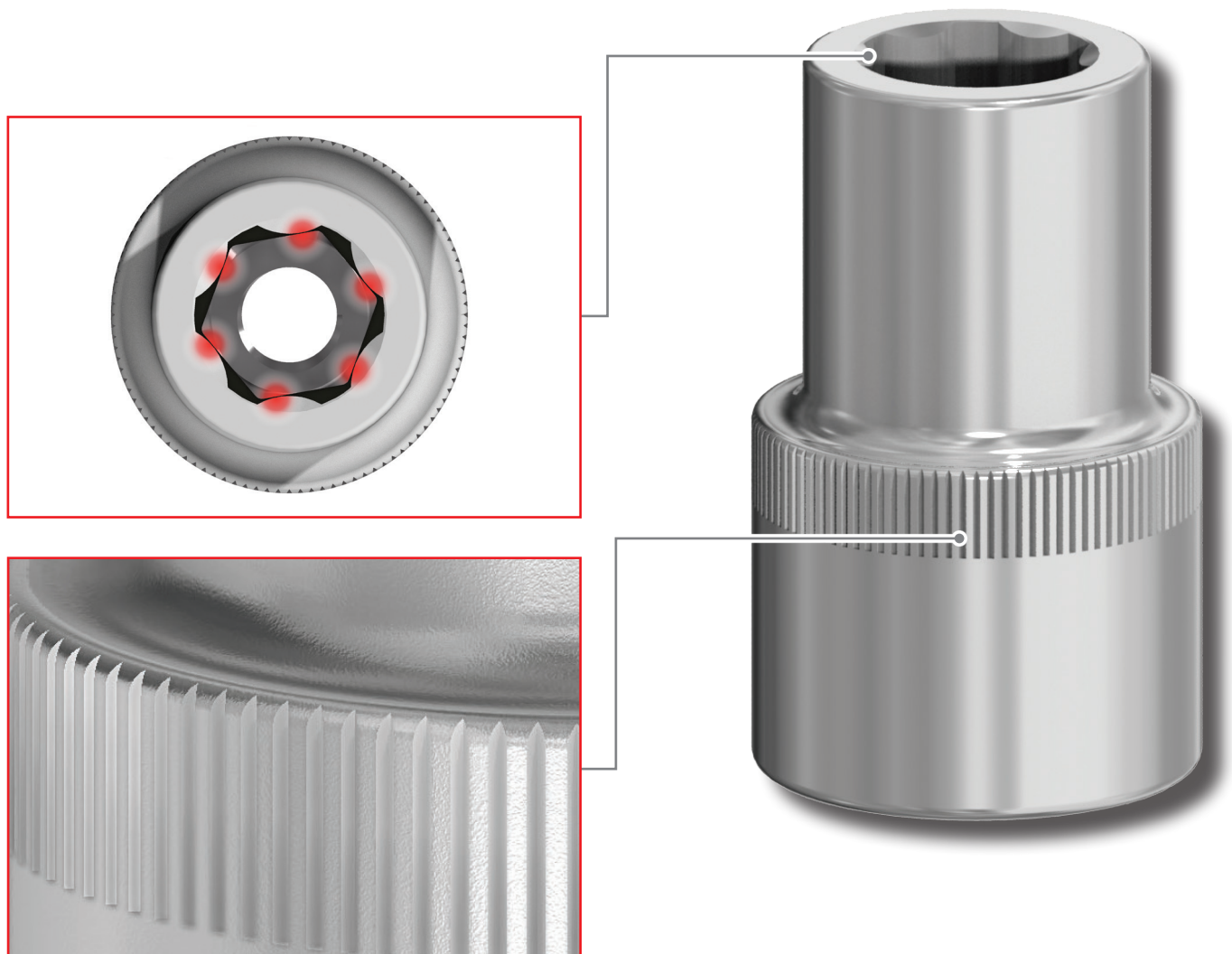

Realizzate in acciaio al Cromo Vanadio di alta qualità. Collare godronato per una miglior presa e resistente rivestimento superficiale di cromatura.

Made in high quality Chrome-Vanadium steel. Knurled collar for better grip and resistant chrome-plated surface coating.



Impronta esagonale tipo SUPER- LOCK: il contatto con il dado non avviene sullo spigolo ma sulla faccia dell'esagono, che offre una maggior superficie di appoggio.

SUPER-LOCK hex tip: the contact with the nut does not take place on the edge, but on the face of the hexagon, which offers a larger support surface.



Indicate per applicazioni manuali in ambito professionale.

Suitable for professional manual applications.

SCHEDE TECNICHE TECHNICAL DATASHEETS

PHILLIPS®

A REGISTERED TRADEMARK OF PHILLIPS SCREW COMPANY



IN ACCORDO A NORME INTERNAZIONALI
IN ACCORDANCE WITH INTERNATIONAL STANDARDS

COPPIA DI TORSIONE SECONDO NORME
TIGHTENING TORQUE IN ACCORDANCE WITH THE STANDARDS

**DIN 5260
ISO 8764**

**DIN 5261*
ISO 8764***

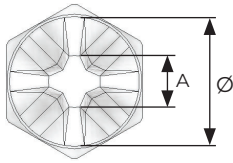
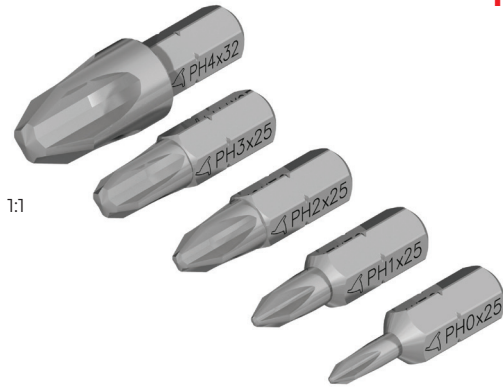

+	A	Ø	Nm	Nm	Autofilettanti per metallo Self-tapping for metal			Autofilettanti per legno Self-tapping for wood			Metriche Metrics			
					ISO 7049 = DIN 7981	ISO 7050 = DIN 7982	ISO 7051 = DIN 7983	DIN 7996	DIN 7997	DIN 7995	ISO 7045 = DIN 7985	ISO 7046 = DIN 965	ISO 7047 = DIN 966	
PH0	0,84	3	1,0	1,0	2,2	2,2	2,2	2,0	2,0	2,0	2,0	2,0	2,0	2,0
PH1	1,30	4,5	3,5	3,8	2,2 2,9	2,2 2,9	2,2 2,9	2,5 3,0	2,5 3,0	2,5 3,0	2,5 3,0	2,5 3,0	2,5 3,0	2,5 3,0
PH2	2,31	6	8,2	10,3	3,5 4,8	3,5 4,8	3,5 4,8	3,5 5,0	3,5 5,0	3,5 5,0	4,0 5,0	4,0 5,0	4,0 5,0	4,0 5,0
PH3	3,84	8	19,5	32,0	5,5 6,3	5,5 6,3	5,5 6,3	5,5 7,0	5,5 7,0	5,5 7,0	6,0	6,0	6,0	6,0
PH4	5,11	10	38,0	88,7	8,0 9,5	8,0 9,5	8,0 9,5	8,0	8,0	8,0	8,0 10,0	8,0 10,0	8,0 10,0	8,0 10,0

* LE NORME PREVEDONO CHE SOTTO IL VALORE DI COPPIA INDICATA IL PROFILO DELL'UTENSILE NON PRESENTI ALCUNA DEFORMAZIONE

* THE STANDARDS REQUIRE THAT THE TOOL PROFILE DOES NOT DEFORM UNDER THE INDICATED TORQUE VALUES

SCHEDE TECNICHE TECHNICAL DATASHEETS

POZIDRIV®

A REGISTERED TRADEMARK OF PHILLIPS SCREW COMPANY



IN ACCORDO A NORME INTERNAZIONALI
IN ACCORDANCE WITH INTERNATIONAL STANDARDS

COPPIA DI TORSIONE SECONDO NORME
TIGHTENING TORQUE IN ACCORDANCE WITH THE STANDARDS

**DIN 5260
ISO 8764**

**DIN 5261*
ISO 8764***

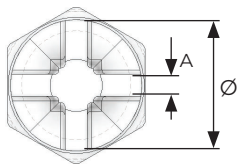

+	A	Ø	Nm	Nm	Autofilettanti per metallo Self-tapping for metal			Autofilettanti per legno Self-tapping for wood			Metriche Metrics		
					ISO 7049 = DIN 7981	ISO 7050 = DIN 7982	ISO 7051 = DIN 7983	DIN 7996	DIN 7997	DIN 7995	ISO 7045 = DIN 7985	ISO 7046 = DIN 965	ISO 7047 = DIN 966
PZ0	0,45	3	1,0	1,0	2,2	2,2	2,2	2,0	2,0	2,0	2,0	2,0	2,0
PZ1	0,71	4,5	3,5	3,8	2,2 2,9	2,2 2,9	2,2 2,9	2,5 3,0	2,5 3,0	2,5 3,0	2,5 3,0	2,5 3,0	2,5 3,0
PZ2	1,00	6	8,2	10,3	3,5 4,8	3,5 4,8	3,5 4,8	3,5 5,0	3,5 5,0	3,5 5,0	4,0 5,0	4,0 5,0	4,0 5,0
PZ3	1,38	8	19,5	32,0	5,5 6,3	5,5 6,3	5,5 6,3	5,5 7,0	5,5 7,0	5,5 7,0	6,0	6,0	6,0
PZ4	2,10	10	38,0	88,7	8,0 9,5	8,0 9,5	8,0 9,5	8,0	8,0	8,0	8,0 10,0	8,0 10,0	8,0 10,0

* LE NORME PREVEDONO CHE SOTTO IL VALORE DI COPPIA INDICATA IL PROFILO DELL'UTENSILE NON PRESENTI ALCUNA DEFORMAZIONE

* THE STANDARDS REQUIRE THAT THE TOOL PROFILE DOES NOT DEFORM UNDER THE INDICATED TORQUE VALUES

SCHEDE TECNICHE TECHNICAL DATASHEETS

TORX®

A REGISTERED TRADEMARK OF ACCUMENT GLOBAL TECHNOLOGIES



IN ACCORDO A NORME INTERNAZIONALI
IN ACCORDANCE WITH INTERNATIONAL STANDARDS

COPPIA DI TORSIONE SECONDO NORME
TIGHTENING TORQUE IN ACCORDANCE WITH THE STANDARDS

TMD-702

TMD-702*

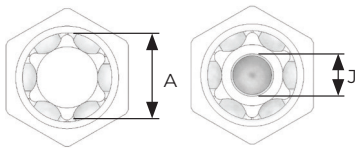

			Autofilettanti per metallo Self-tapping for metal			Autofilettanti per legno Self-tapping for wood			Metriche Metrics							

	A	J	 Nm	 Nm	 Nm	ISO 7049 = DIN 7981	ISO 7050 = DIN 7982	ISO 7051 = DIN 7983	DIN 7996	DIN 7997	DIN 7995	ISO 7045 = DIN 7985	ISO 7046 = DIN 965	ISO 7047 = DIN 966	DIN 912 7984 6912	ISO 4762 = DIN 912	ISO 10642 = DIN 7991
TX03	1,12			0,25								1,2	1,4	1,4	1,2		
TX04	1,30			0,37													
TX05	1,37		0,43	0,51								1,4 1,6	1,8		1,4 1,6		
TX06	1,65		0,75	0,91		2,2	2,2					1,3 2,0	2,0		1,3 2,0		
TX07	1,97		1,4	1,7													
TX08	2,30	0,74	2,2	2,6	2,2	2,9	2,9	2,9				2,5	2,5	2,5		2,5	
TX09	2,48	0,81	2,8	3,4	2,9	2,9											
TX10	2,27	0,94	3,7	4,5	3,8	3,5	3,5	3,5	3,0	3,0		3,0	3,0	3,0	3,0	3,0	3,0
TX15	3,26	1,19	6,4	7,7	6,5	3,9	3,9	3,9	3,5	3,5		3,5	3,5	3,5	3,5		
TX20	3,84	1,57	10,5	12,7	10,8	4,2	4,2	4,2	4,0 4,5	4,0 4,5	4,5	4,0	4,0	4,0	4,0	4,0	4,0
TX25	4,40	1,96	15,9	19,0	16,1	4,8 5,5	4,8 5,5	4,8 5,5	4,5 6,0	4,5 5,0	4,5	5,0	5,0	5,0	4,0 5,0	5,0	5,0
TX27	4,96	2,21	22,5	26,9	22,9										4,3 5,0		
TX30	5,49	2,72	31,1	37,4	31,8	6,3	6,3	6,3	6,0	6,0		6,0	6,0	6,0	6,0	6,0	6,0
TX40	6,60	3,15	54,1	65,1	55,3	8,0				8,0 10,0		8,0	8,0	8,0	8,0		8,0
TX45	7,77	3,40	86,0	104,0	88,0											8,0	
TX50	8,79	3,73	132,0	159,0	135,0	10,0						10,0	10,0	10,0	10,0	10,0	10,0
TX55	11,17	4,75		257,0	218,0	12,0									12,0	12,0	
TX60	13,20	5,56		445,0	379,0										14,0	14,0	
TX70	15,49	6,73		701,0	596,0												

* PER QUESTO PROFILO I VALORI DI COPPIA INDICATI CORRISPONDONO AL VALORE MINIMO DI ROTTURA
* THE TORQUE VALUES INDICATED FOR THIS PROFILE CORRESPOND TO THE MINIMUM BREAKING VALUE

SCHEDE TECNICHE TECHNICAL DATASHEETS

TORX-PLUS®

TORX-PLUS® TAMPER RESISTANT

A REGISTERED TRADEMARK OF ACCUMENT GLOBAL TECHNOLOGIES



IN ACCORDO A NORME INTERNAZIONALI
IN ACCORDANCE WITH INTERNATIONAL STANDARDS

COPPIA DI TORSIONE SECONDO NORME
TIGHTENING TORQUE IN ACCORDANCE WITH THE STANDARDS

NMD-702
NMD-602

NMD-702*
NMD-602*

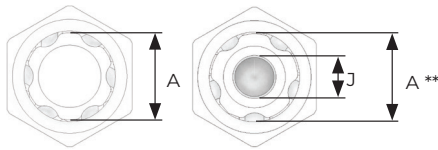

** DIAMETRO CIRCOSCRITTO · ** CIRCUMSCRIBED DIAMETER ·

		Autofilettanti per metallo Self-tapping for metal			Metriche Metrics												
	A		Nm		A	J		Nm	ISO 7049 = DIN 7981	ISO 7050 = DIN 7982	ISO 7051 = DIN 7983	ISO 7045 = DIN 7985	ISO 7046 = DIN 965	ISO 7047 = DIN 966	DIN 912 = 7984 = 6912	ISO 4762 = DIN 912	ISO 10642 = DIN 7991
10IP	2,72	5,42		10IPR	2,72	0,91	4,3		3,5	3,5	2,9 3,5	3,0	3,0	3,0	3,0	3,0	5,0
15IP	3,25	9,62		15IPR	3,25	1,17	7,3		3,9	3,9	3,5 3,9	3,5	3,5 4,0	3,5			6,0
20IP	3,84	16,15		20IPR	3,84	1,55	11,9		4,2	4,2	4,2	4,0	4,0 5,0	4,0	4,0	4,0	6,0
25IP	4,39	23,50		25IPR	4,39	1,93	17,4		4,8 5,5	4,8 5,5	4,8 5,5	5,0	5,0 6,0	5,0	5,0	5,0	7,0 8,0
27IP	4,95	34,62		27IPR	4,95	2,18	25,1										8,0
30IP	5,49	47,18		30IPR	5,49	2,57	33,5		6,3	6,3	6,3	6,0	6,0	6,0	8,0	6,0	
40IP	6,60	82,08		40IPR	6,60	2,92	59,4				8,0		8,0	8,0	8,0	8,0	10,0

* PER QUESTO PROFILO I VALORI DI COPPIA INDICATI CORRISPONDONO AL VALORE MINIMO DI ROTTURA

* THE TORQUE VALUES INDICATED FOR THIS PROFILE CORRESPOND TO THE MINIMUM BREAKING VALUE

SCHEDE TECNICHE TECHNICAL DATASHEETS

ESAGONO



IN ACCORDO A NORME INTERNAZIONALI
IN ACCORDANCE WITH INTERNATIONAL STANDARDS

COPPIA DI TORSIONE SECONDO NORME
TIGHTENING TORQUE IN ACCORDANCE WITH THE STANDARDS

DIN 911
DIN 7426

DIN 7426*
ISO 2936*

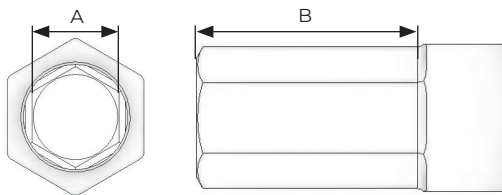

Ø	A	B _{MIN}	Nm	Nm	Metriche Metrics				
					DIN 7984	ISO 4762 = DIN 7984	ISO 10642 = DIN 7991	DIN 908	DIN 913 914 DIN 915 916
0,7	0,7	1,6	0,08						1,4 1,8
0,9	0,9	1,8	0,18						2,0
1,3	1,3	2,0	0,53			1,4			2,5
1,5	1,5	2,3	0,82	0,95		1,6 2,0			3,0
2,0	2,0	3,0	1,9	2,3	3,0	2,5	3,0		4,0
2,5	2,5	3,8	3,4	4,4	4,0	3,0	4,0		5,0
3,0	3,0	4,5	6,6	7,6	5,0	4,0	5,0		6,0
4,0	4,0	6,0	16,0	18,0	6,0	5,0	6,0		8,0
5,0	5,0	7,5	30,0	35,0	8,0	6,0	8,0	10,0	10,0
6,0	6,0	9,0	52,0	61,0		8,0	10,0	12,0 14,0	12,0 14,0
7,0	7,0	10,5	78,0	97,0	10,0				
8,0	8,0	12,0	120,0	140,0	12,0	10,0	12,0	16,0 18,0	16,0 18,0
10,0	10,0	16,0	220,0	280,0	14,0	12,0	14,0 16,0	20,0 22,0	20,0 22,0
12,0	12,0	18,0	370,0	480,0	16,0 18,0	14,0	18,0 20,0	24,0 26,0	24,0 26,0
14,0	14,0	25,0	590,0		20,0 22,0	16,0 18,0	22,0 24,0		

* LE NORME PREVEDONO CHE SOTTO IL VALORE DI COPPIA INDICATA IL PROFILO DELL'UTENSILE NON PRESENTI ALCUNA DEFORMAZIONE

* THE STANDARDS REQUIRE THAT THE TOOL PROFILE DOES NOT DEFORM UNDER THE INDICATED TORQUE VALUES

SCHEDE TECNICHE TECHNICAL DATASHEETS

TAGLIO



IN ACCORDO A NORME INTERNAZIONALI
IN ACCORDANCE WITH INTERNATIONAL STANDARDS

COPPIA DI TORSIONE SECONDO NORME
TIGHTENING TORQUE IN ACCORDANCE WITH THE STANDARDS

DIN-ISO 2380

DIN-ISO 2380*

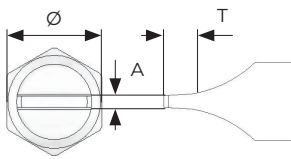

Ø	A	T	Nm	Nm	Autofilettanti per metallo Self-tapping for metal			Autofilettanti per legno Self-tapping for wood			Metriche Metrics						
					ISO 1481 = DIN 7971	ISO 1482 = DIN 7972	ISO 1483 = DIN 7973	DIN 96	DIN 97	DIN 95	ISO 1207 = DIN 84	ISO 1580 = DIN 85	ISO 2009 = DIN 963	ISO 2010 = DIN 964	ISO 4766 7435 = DIN 417-427		
1,5	0,30	0,50		0,15													
1,8	0,37	0,50		0,28								1,2 1,4					
2,0	0,40	0,70	0,3	0,35				1,6	1,6					1,6			2,5 3,0
2,5	0,40	0,70	0,4	0,45				2,0		1,6		1,6 1,8			1,6		3,5
3,0	0,50	0,90	0,7	0,8		2,2	2,2		2,0	2,0	2,0	2,0		2,0	2,0		4,0
3,5	0,60	1,10	1,3	1,4	2,2			2,5	2,5	2,5	2,5			2,5	2,5		
4,0	0,50	0,90		1,1				2,0									
4,0	0,80	1,40	2,6	2,9	2,9	2,9	2,9	3,0 3,5	3,0 3,5	3,0 3,5	3,0	3,0	3,0 3,5	3,0 3,5	3,0 3,5		5,0 6,0
4,5	0,60	1,10		1,8	2,2			2,5				2,5					
5,0	0,80	1,40	3,2	3,6													
5,5	0,80	1,40	3,5	3,9				3,5		3,5	3,0	3,5	3,5	3,5	3,5		
5,5	1,00	1,80	5,5	6,2	3,5 3,9	3,5 3,9	3,5 3,9	4,0 4,5	4,0 4,5	4,0 4,5	3,5	3,5	4,0	4,0			
6,0	1,00	1,80		6,7													
6,5	1,20	2,20	9,4	10,5		4,2 4,8	4,2	5,0 5,5	5,0	5,0	4,0		5,0	5,0			8,0
7,0	1,20	2,20	10,0	11,3													
8,0	1,20	2,20	11,5	12,9	4,2		4,8		5,5	5,5	5,0	4,0					
8,0	1,60	2,90	20,5	22,9	4,8	5,5 6,3	5,5	6,0	6,0	6,0		5,0	6,0	6,0			10,0 12,0
10,0	1,60	2,90	25,6	28,7	5,5 6,3		6,3		7,0 8,0	7,0	6,0						14,0
13,0	2,00	3,60	52,0	58,0				8,0	10,0		8,0	8,0	8,0	8,0			16,0

* LE NORME PREVEDONO CHE SOTTO IL VALORE DI COPPIA INDICATA IL PROFILO DELL'UTENSILE NON PRESENTI ALCUNA DEFORMAZIONE

* THE STANDARDS REQUIRE THAT THE TOOL PROFILE DOES NOT DEFORM UNDER THE INDICATED TORQUE VALUES

SCHEDE TECNICHE TECHNICAL DATASHEETS

TORX®

A REGISTERED TRADEMARK OF ACCUMENT GLOBAL TECHNOLOGIES



IN ACCORDO A SPECIFICA ACCUMENT GLOBAL TECHNOLOGIES
IN ACCORDANCE WITH THE SPECIFICATIONS OF ACCUMENT GLOBAL TECHNOLOGIES

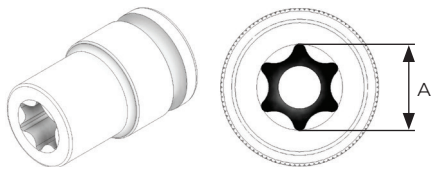

Metriche
Metrics



	A	ISO 4014 - 4017 = DIN 931 - 933	ISO 8100 = DIN 6921
E5	4,72	4,0	
E6	5,69	5,0	4,0
E7	6,17		
E8	7,47	6,0 7,0	5,0
E10	9,37	8,0	6,0
E11	10,03		
E12	11,12	10,0 11,0	8,0
E14	12,85	12,0	10,0
E16	14,71		
E18	16,64	14,0	12,0
E20	18,41	16,0	14,0
E22	20,24		
E24	22,09	18,0 20,0	

SCHEDE TECNICHE TECHNICAL DATASHEETS

ESAGONO



IN ACCORDO A NORME INTERNAZIONALI
IN ACCORDANCE WITH INTERNATIONAL STANDARDS

COPPIA DI TORSIONE SECONDO NORME
TIGHTENING TORQUE IN ACCORDANCE WITH THE STANDARDS

DIN 3129

DIN-ISO 1711*



			Autofilettanti per metallo <i>Self-tapping for metal</i>	Autofilettanti per legno <i>Self-tapping for wood</i>	Metriche <i>Metrics</i>		
	 Nm	 Nm	ISO 1479 = DIN 7976	DIN 571	ISO 4014 4016 4017	ISO 4035 4036 = DIN 439	ISO 4032 4033 = DIN 934
4		10,4			2,0	2,0	2,0
4,5		12,6			2,3		
5	11,5	15,1	2,9		2,5	2,5	2,5
5,5	14,4	17,8	3,5		3,0	3,0	3,0
6	17,6	23,2			3,5	3,5	3,5
7	25,2	33,2	3,9 4,2	4,0	4,0	4,0	4,0
8*	34,5	94,1	4,8 5,5	5,0	5,0	5,0	5,0
9*	45,4	119,2					
10*	58,1	147,0	6,3	6,0	6,0	6,0	6,0
11*	72,7	178,0			7,0		7,0
12*	89,1	212,0		7,0			
13*	107,0	249,0	8,0	8,0	8,0	8,0	8,0
14*	128,0	288,0					

* VALUTARE ANCHE RESISTENZA ATTACCO











































* ALSO EVALUATE ATTACHMENT RESISTANCE

SCHEDE TECNICHE

TECHNICAL DATASHEETS

ATTACCHI MASCHIO STANDARD, APPLICAZIONI, RESISTENZE

STANDARD MALE ATTACHMENTS, APPLICATIONS, RESISTANCES



	 A  B		APPLICAZIONE APPLICATION	STANDARDS	Nm
	A=3mm			DIN 3126 Form A3	7,6
	A=4mm - 5/32"			DIN 3126 Form C4	18,0
	A=5,5mm			DIN 3126 Form A5,5	47,0
	B=VARIE			LTI	N.A.
	B=7mm			LTI	N.A.
	A=6,35mm - 1/4"			DIN 3126 Form C6,3	71,0
	A=6,35mm - 1/4"			DIN 3126 Form E6,3	71,0
	A=7,93mm - 5/16"			DIN 3126 Form C8	144,0
	A=7,93mm - 5/16"			FIAM-DESOUTTER	144,0
	A=9,52mm - 3/8"			AUTOMOTIVE	280,0
	A=11,2mm - 7/16"			DIN 3126 Form E11,2	396,0
	B=M4x0,7			ISO 724 - DIN 13.1	7,0
	B=M5x0,8			ISO 724 - DIN 13.1	18,0
	B=M6x1			ISO 724 - DIN 13.1	25,0
	B=10x32 UNF			ISO 724 - DIN 13.1	18,0
	B=BSF 3/16x32 Whitworth			ISO 724 - DIN 13.1	18,0







SCHEDE TECNICHE

TECHNICAL DATASHEETS

ATTACCHI QUADRO STANDARD, APPLICAZIONI, RESISTENZE

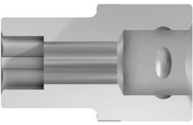
STANDARD SQUARE ATTACHMENTS, APPLICATIONS, RESISTANCES

			APPLICAZIONE APPLICATION	STANDARDS	Nm
	A=6,35mm - 1/4"			DIN 3121 Form G6,3	68,6
	A=9,52mm - 3/8"			DIN 3121 Form G10	225,0
	A=12,70mm - 1/2"			DIN 3121 Form G12,5	569,0
	A=19,05mm - 3/4"			DIN 3121 Form H20	1569,0
	A=25,40mm - 1"			DIN 3121 Form H25	2795,0
	A=38,10mm - 1-1/2"			DIN 3121 Form H40	

			APPLICAZIONE APPLICATION	STANDARDS	Nm
	A=6,35mm - 1/4"			DIN 3121 Form G6,3	62,0
	A=9,52mm - 3/8"			DIN 3121 Form G10	202,0
	A=12,70mm - 1/2"			DIN 3121 Form G12,5	512,0
	A=19,05mm - 3/4"			DIN 3121 Form D20	1412,0