

Datasheet

Red Cable Mount Female 3P+N+E Straight Industrial Power Socket Rated At 16A, 400 V ac

RS Stock number [724-9110](#)

PLUGS

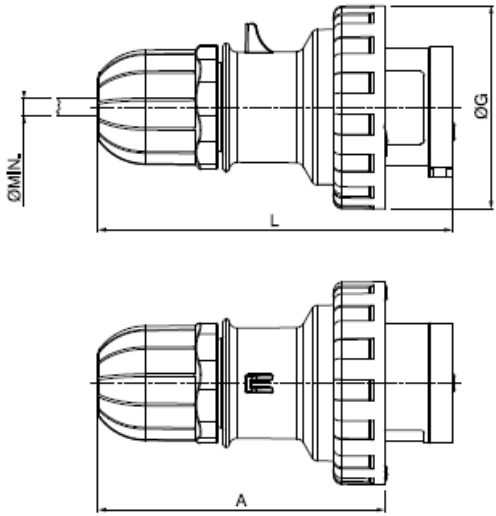
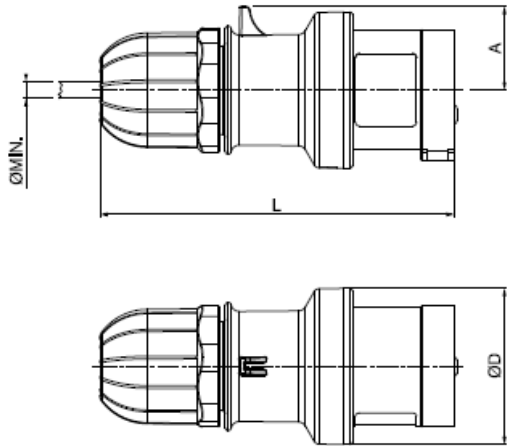

IP44		A	Ø D	L Min	Ø Min
16A	2P+E	30	56	128	6
	3P+E	34	60	135	6
	3P+N+E	38	65	153	9
32A	2P+E	40	65	162	9
	3P+E	40	65	162	9
	3P+N+E	45	73	176	13

IP66/IP67		A	Ø G	L Min	Ø Min
16A	2P+E	103	73	128	6
	3P+E	110	81	135	6
	3P+N+E	129	88	153	9
32A	2P+E	131	93	162	9
	3P+E	131	93	162	9
	3P+N+E	145	101	176	13
63A		160	112	220	17
125A		202	128	272	26

APPLIANCE INLETS - IP44

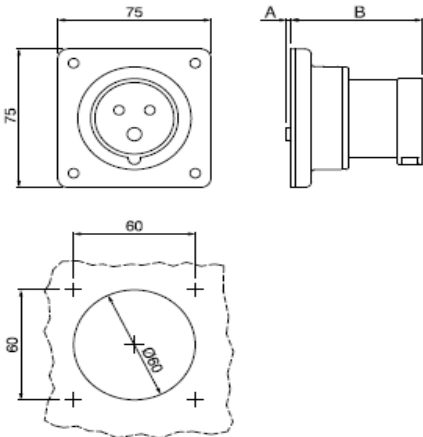

IP44		A	B
16A	2P+E	2	65
	3P+E	2	65
	3P+N+E	2	65
32A	2P+E	19	73
	3P+E	19	73
	3P+N+E	19	73

CONNECTORS

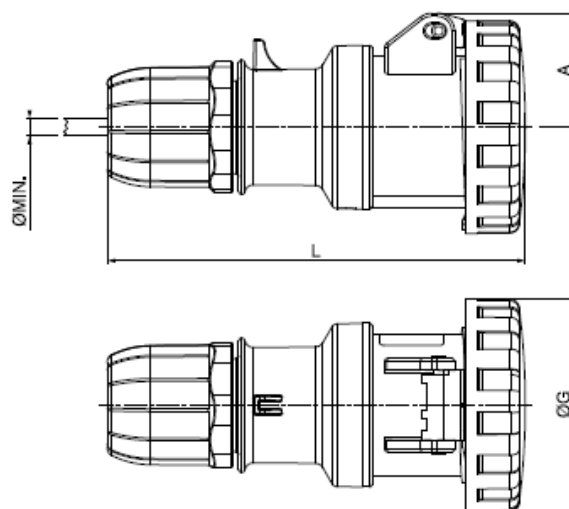
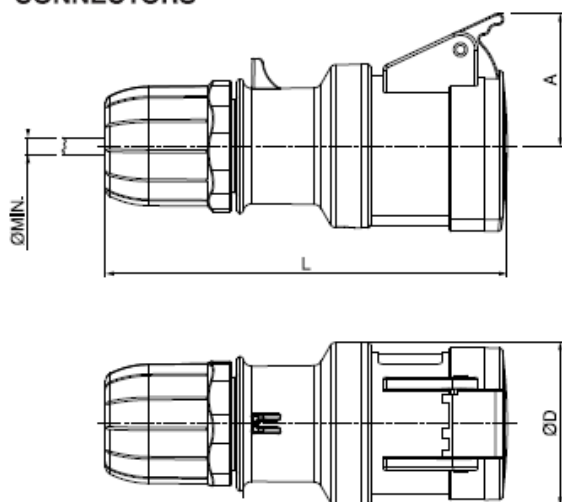

IP44		A	Ø D	L Min	Ø Min
16A	2P+E	46	56	138	6
	3P+E	49	60	145	6
	3P+N+E	54	65	165	9
32A	2P+E	54	65	175	9
	3P+E	54	65	175	9
	3P+N+E	59	73	190	13

IP66/IP67		A	Ø G	L Min	Ø Min
16A	2P+E	39	73	141	6
	3P+E	43	81	148	6
	3P+N+E	51	88	168	9
32A	2P+E	56	93	178	9
	3P+E	56	93	178	9
	3P+N+E	52	101	195	13
63A		57,5	112	230	17
125A		64,25	128	288	26

APPLIANCE INLETS - IP66/IP67

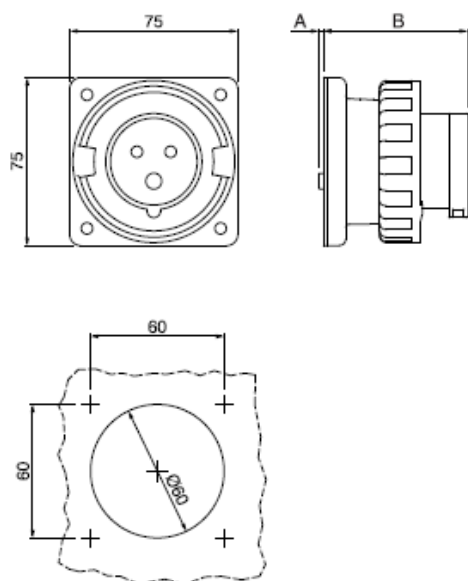

IP66/IP67		A	B
16A	2P+E	2	65
	3P+E	2	65
	3P+N+E	2	65
32A	2P+E	19	73
	3P+E	19	73
	3P+N+E	19	73