

General Specifications

Electrical Capacity (Resistive Load)

Power Level (silver): 6A @ 125V AC & 3A @ 250V AC

4A @ 30V DC for On-None-On & On-None-Off; 3A @ 30V DC for all other circuits

Logic Level (gold): 0.4VA maximum @ 28V AC/DC maximum (Applicable Range 0.1mA ~ 0.1A @ 20mV ~ 28V)

Logic/Power Level (gold over silver): Combines silver & gold ratings

Note: Find additional explanation of dual rating & operating range in Supplement section.

Other Ratings

Contact Resistance: 10 milliohms maximum for silver; 20 milliohms maximum for gold

Insulation Resistance: 1,000 megohms minimum @ 500V DC

Dielectric Strength: 1,000V AC minimum between contacts for 1 minute minimum;
1,500V AC minimum between contacts and case for 1 minute minimum

Mechanical Life: 100,000 operations minimum; 50,000 operations minimum for flat, locking & splashproof devices

Electrical Life: 25,000 operations minimum for silver; 50,000 operations minimum for gold;

50,000 operations minimum for silver at 3A @ 125V AC

Angle of Throw: 25°

Materials & Finishes

Toggle: Brass with chrome plating

Frame: Stainless steel

Bushing: Brass with nickel plating

Support Bracket: Brass with tin plating

Case: Diallyl phthalate resin (UL94V-0)

Movable Contactor: Phosphor bronze with silver or gold plating

Movable Contacts: Silver alloy (code W); copper with gold plating (code G); or silver alloy with gold plating (code A)

Stationary Contacts: Silver with silver plating (code W); copper or brass with gold plating (code G);
or silver with gold plating (code A)

Terminals: Copper or brass with silver plating; or copper or brass with gold plating

Environmental Data

Operating Temp Range: -30°C through +85°C (-22°F through +185°F)

Humidity: 90 ~ 95% humidity for 96 hours @ 40°C (104°F)

Vibration: 10 ~ 55Hz with peak-to-peak amplitude of 1.5mm traversing the frequency range & returning in 1 minute; 3 right angled directions for 2 hours

Shock: 50G (490m/s²) acceleration (tested in 6 right angled directions, with 5 shocks in each direction)

Sealing: Splashproof bushing options B3, D3, D8, L3, & L8, which have o-rings inside & outside the bushing, meet IP67 of IEC60529 Standards.

Installation

Mounting Torque: 3.0Nm (26.55 lb•in) double nut for large bushing;
1.5Nm (13 lb•in) double nut & 0.7Nm (6 lb•in) single nut for all other bushings

Processing

Soldering: Wave Soldering (PC version) for Gold: See Profile A in Supplement section.

Manual Soldering for Gold: See Profile A in Supplement section.

Wave Soldering (PC version) for Silver: See Profile B in Supplement section.

Manual Soldering for Silver: See Profile B in Supplement section.

Note: Lever must be in OFF (center) position while soldering.

Cleaning: These devices are not process sealed. Hand clean locally using alcohol based solution.

Standards & Certifications

Flammability Standards: UL94V-0 for case

UL: File No. E44145 - Recognized only when ordered with marking on switch.

Add "/U" or "/CUL" before dash in part number to order UL recognized switch.

All models recognized at 6A @ 125V AC, 3A @ 250V AC or 0.4VA maximum @ 28V DC maximum.

CSA: File No. 023535_0_000 - Certified only when ordered with marking on switch.

Add "/C" before dash in part number to order CSA certified switch.

All models certified at 6A @ 125V AC or 3A @ 250V AC or 0.4VA maximum @ 28V maximum.

Distinctive Characteristics

Antirootation design, standard on noncylindrical levers, mates toggle and bushing; bottom of toggle has two flatted sides which fit into a complementary opening inside bushing.

Antijamming design protects contacts from damage due to excessive downward force on actuator.

High torque bushing construction prevents rotation or separation from frame during installation.

High insulating barriers increase isolation of circuits in multipole devices and provide added protection to contact points.

Molded diallyl phthalate case has a UL flammability rating of 94V-0.

Epoxy sealed terminals prevent entry of solder flux and other contaminants.

Prominent external insulating barriers increase insulation resistance and dielectric strength.

Interlocked actuator block, lever, and interior guide prevent switch failure due to biased lever movement.

Clinching of frame to case well above base and terminals provides 1,500V dielectric strength.

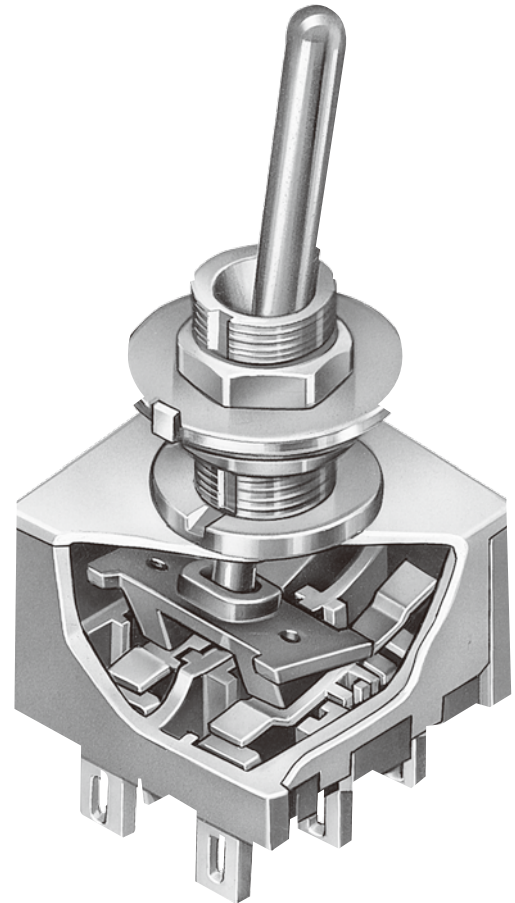

Actual Size

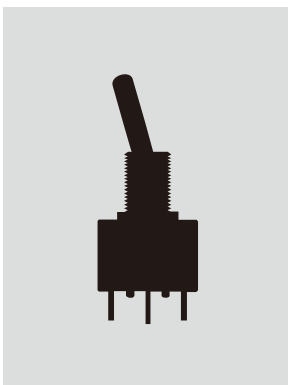

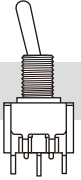
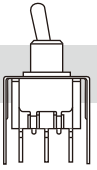
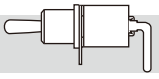
	Bushing Mount	Page A52
	Bracket PC Mount	Page A64
	Angle PC Mount	Page A70

Toggles
A
Rockers
Pushbuttons
Illuminated PB
Programmable
Keylocks
Rotaries
Slides
Tactiles
Tilt
Touch
Indicators
Accessories
Supplement

TYPICAL SWITCH

M20

1

3

S

S1

Poles

1	SPST SPDT
2	DPST DPDT SP3T
3	3PDT
4	4PDT DP3T

Small Toggles

S	.413" (10.5mm) Bat
S2	.200" (5.08mm) Bat
S3	.256" (6.5mm) Bat
E	.450" (11.4mm) Flatted
*E2	.256" (6.5mm) Flatted
E4	.840" (21.3mm) Flatted
*Q	.550" (14.0mm) Cone
*Q2	.640" (16.26mm) Cone
*Q4	.840" (21.3mm) Cone
*C	.571" (14.5mm) Color Tipped Cone (available in colors A, B & C only)
*D	.840" (21.3mm) Color Capped Cone

Specify cap color for toggles C & D at the end of the part number.
* Available on 1- and 2-pole only.

Small Bushings

S1	.350" (8.9mm) Threaded with Keyway
S4	6mm .350" (8.9mm) Threaded with Keyway
S2	.350" (8.9mm) Smooth with Keyway
A1	.280" (7.1mm) Threaded with Keyway
A2	.280" (7.1mm) Smooth with Keyway
D1	.350" (8.9mm) Threaded with D Flat
D4	6mm .350" (8.9mm) Threaded with D Flat
D3	.350" (8.9mm) Threaded Splashproof with D Flat (combines only with S, S2 & S3)
D8	6mm .350" (8.9mm) Threaded Splashproof with D Flat (combines only with S, S2 & S3)

Circuits

*1	ON	NONE	OFF
2	ON	NONE	ON
3	ON	OFF	ON
5	ON	NONE	(ON)
8	(ON)	OFF	(ON)
9	ON	OFF	(ON)
**4	ON	ON	ON
**6	(ON)	ON	(ON)
**7	ON	ON	(ON)

() = Momentary

* ON-NONE-OFF circuit available in 1- and 2-pole only.

** 3-ON circuits

Large Toggles

B	.453" (11.5mm) Large Bat
B2	.689" (17.5mm) Large Bat
R	.610" (15.5mm) Large Flatted

Large Bushings

B1	Large .472" (12mm) Threaded with Keyway
B3	Large .472" (12mm) Threaded Splashproof with D Flat

Locking Lever

L	.201" (5.1mm) Dia. Locking Lever
---	----------------------------------

Bushings For Locking Levers

L1	.291" (7.4mm) Threaded with Keyway for Lever Lock
L4	6mm .291" (7.4mm) Threaded with Keyway for Lever Lock
L2	Smooth with Keyway for Lever Lock
L3	.295" (7.5mm) Threaded Splashproof with D Flat for Lever Lock
L8	6mm .295" (7.5mm) Threaded Splashproof with D Flat for Lever Lock

IMPORTANT:



Switches are supplied without UL, cULus & CSA marking unless specified.
UL, cULus & CSA recognized only when ordered with marking on the switch.
 Specific models, ratings, & ordering instructions are noted on the General Specifications page.

ORDERING EXAMPLE

Contact Materials & Ratings	
W	Silver; Rated 6A @ 125V AC & 3A @ 250V AC
G	Gold; Rated 0.4VA max @ 28V AC/DC max
A	Gold over Silver; Rated 6A @ 125V AC & 0.4VA max @ 28V AC/DC max

Optional Caps	
For Small Bat Toggles	
B	For S Bat Toggle
C	Conical Cap for S Bat Toggle
For Large Bat Toggles	
R	For B Toggle
V	For B2 Toggle

Cap Colors	
A	Black
B	White
C	Red
E	Yellow
F	Green
G	Blue

Terminals	
01	Solder Lug
02	Quick Connect
03	.250" (6.35mm) Straight PC
05	.425" (10.8mm) Wirewrap
06	.750" (19.05mm) Wirewrap
07	.964" (24.5mm) Wirewrap
08	1.062" (27.0mm) Wirewrap

Cap for Locking Lever	
No Code	Nickel Plated Supplied with Switch
A	Black
C	Red
G	Blue





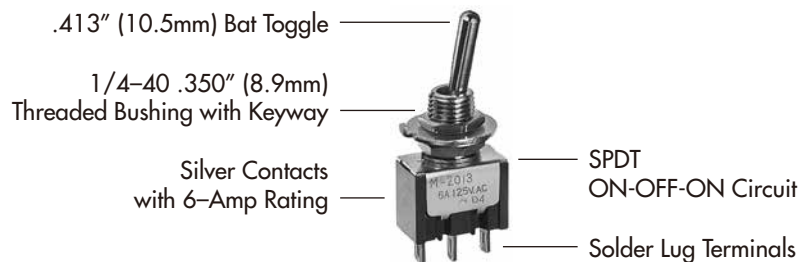



DESCRIPTION FOR TYPICAL ORDERING EXAMPLE

M2013SS1W01



Toggles A
 Rockers
 Pushbuttons
 Illuminated PB
 Programmable
 Keylocks
 Rotaries
 Slides
 Tactiles
 Tilt
 Touch
 Indicators
 Accessories
 Supplement

POLES & CIRCUITS

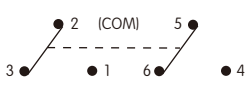
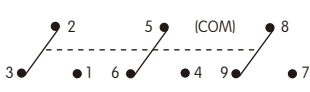
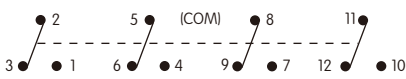
Pole	Model	Toggle Position () = Momentary			Connected Terminals			Throw & Schematics
		Down 	Center 	Up 	Down 	Center 	Up 	
SP	M2011	ON	NONE	OFF	2-3	OPEN	OPEN	SPST 
SP	M2012 M2013 M2015 M2018 M2019	ON ON ON (ON) ON	NONE OFF NONE OFF OFF	ON ON (ON) (ON) (ON)	2-3	OPEN	2-1	SPDT 
DP	M2021	ON	NONE	OFF	2-3 5-6	OPEN	OPEN	DPST 
DP	M2022 M2023 M2025 M2028 M2029	ON ON ON (ON) ON	NONE OFF NONE OFF OFF	ON ON (ON) (ON) (ON)	2-3 5-6	OPEN	2-1 5-4	DPDT 
3P	M2032 M2033 M2035 M2038 M2039	ON ON ON (ON) ON	NONE OFF NONE OFF OFF	ON ON (ON) (ON) (ON)	2-3 5-6 8-9	OPEN	2-1 5-4 8-7	3PDT 
4P	M2042 M2043 M2045 M2048 M2049	ON ON ON (ON) ON	NONE OFF NONE OFF OFF	ON ON (ON) (ON) (ON)	2-3 5-6 8-9 11-12	OPEN	2-1 5-4 8-7 11-10	4PDT 

For 3 Throw (3-On)

Connected Terminals & Schematic

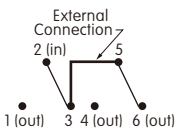
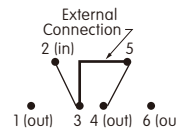
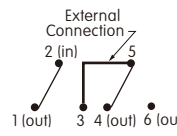
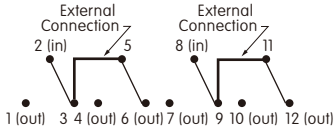
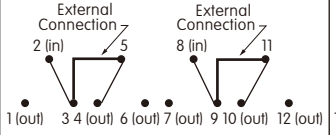
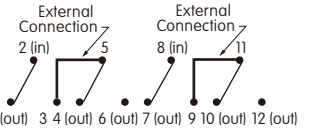
Pole	Model	Down	Center	Up	Down	Center	Up
SP	M2024 M2026 M2027	ON (ON) ON	ON ON ON	ON (ON) (ON)	 2-3 5-6	 2-3 5-4	 2-1 5-4
DP	M2044 M2046 M2047	ON (ON) ON	ON ON ON	ON (ON) (ON)	 2-3 5-6 8-9 11-12	 2-3 5-4 8-9 11-10	 2-1 5-4 8-7 11-10

The SP3T model utilizes a double pole base.

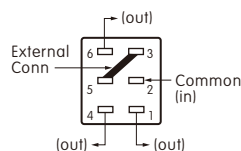

External connection must be made during field installation.

The DP3T model utilizes a four pole base.

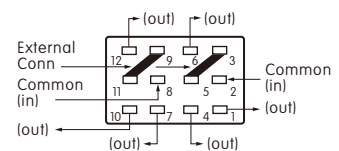

External connection must be made during field installation.

SMALL TOGGLES

S .413" (10.5mm) Bat

S2 .200" (5.08mm) Bat

S3 .256" (6.5mm) Bat

Important:

Toggle length changes based on bushing selected. All illustrations are shown with .350" long bushing. When using a .280" long bushing, toggle length increases .070".

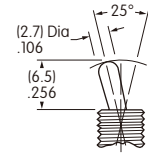
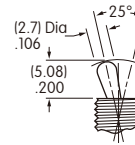
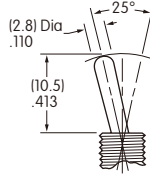

Standard Material & Finish: Brass with Bright Chrome

E .450" (11.4mm) Flatted

E2 .256" (6.5mm) Flatted

E4 .840" (21.3mm) Flatted

C .571" (14.5mm) Color Tipped Cone
Supplied with Cap AT445

Colors: A B C
Material: Polycarbonate

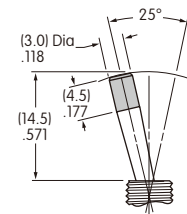
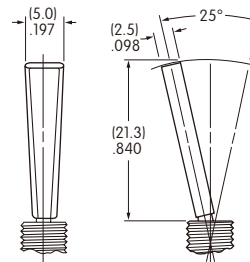
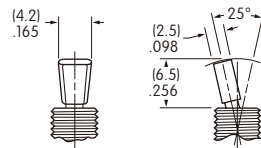
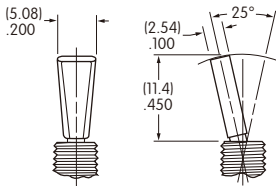

Only Available in 1- & 2-Pole

Only Available in 1- & 2-Pole

Q .550" (14.0mm) Cone

Q2 .640" (16.26mm) Cone

Q4 .840" (21.3mm) Cone

D .840" (21.3mm) Color Capped Cone
Supplied with Cap AT460

Colors: A B C E F G
Material: Polyethylene

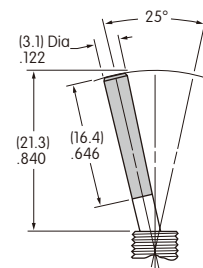
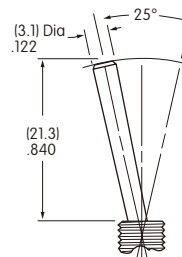
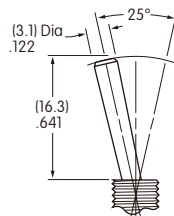
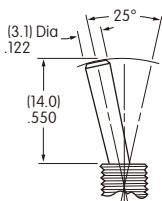

Only Available in 1- & 2-Pole

Only Available in 1- & 2-Pole

Only Available in 1- & 2-Pole

Cap Colors Available:

A Black

B White

C Red

E Yellow

F Green

G Blue

Toggles
 Rockers
 Pushbuttons
 Illuminated PB
 Programmable
 Keylocks
 Rotaries
 Slides
 Tactiles
 Tilt
 Touch
 Indicators
 Accessories
 Supplement

Toggles
 Rockers
 Pushbuttons
 Illuminated PB
 Programmable
 Keylocks
 Rotaries
 Slides
 Tactiles
 Tilt
 Touch
 Indicators
 Accessories
 Supplement

SMALL BUSHINGS

S1 1/4-40 .350" (8.9mm)
Threaded with Keyway

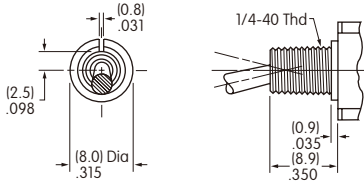

Maximum Panel Thickness with Standard Hardware: .102" (2.6mm)

S4 6mm/.350" (8.9mm)
Threaded with Keyway

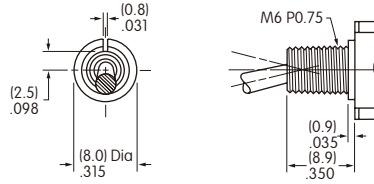

Maximum Panel Thickness with Standard Hardware: .102" (2.6mm)

S2 .350" (8.9mm)
Smooth with Keyway

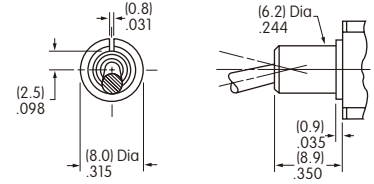

A1 1/4-40 .280" (7.1mm)
Threaded with Keyway

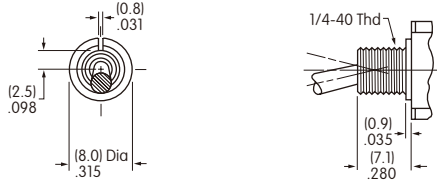

When using this bushing, toggle length is increased by .070". Maximum Panel Thickness with Standard Hardware: .031" (0.8mm)

A2 .280" (7.1mm)
Smooth with Keyway

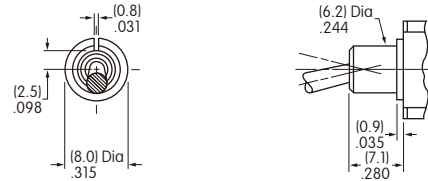

When using this bushing, toggle length is increased by .070".

D1 1/4-40 .350" (8.9mm)
Threaded with D Flat

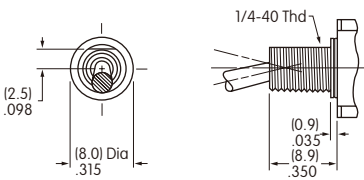

Maximum Panel Thickness with Standard Hardware: .102" (2.6mm)

D4 6mm/.350" (8.9mm)
Threaded with D Flat

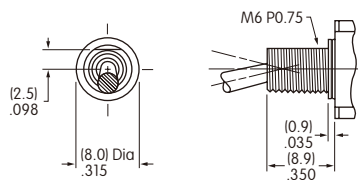

Maximum Panel Thickness with Standard Hardware: .102" (2.6mm)

D3 1/4-40 .350" (8.9mm)
Threaded Splashproof with D Flat

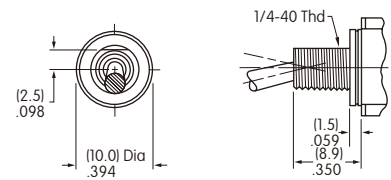

D3 combines only with S, S2 & S3 toggles. Maximum Panel Thickness with Standard Hardware: .193" (4.9mm)

D8 6mm/.350" (8.9mm)
Threaded Splashproof with D Flat

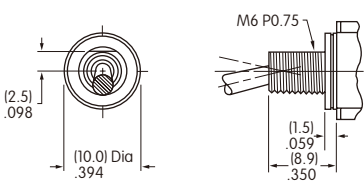

D8 combines only with S, S2 & S3 toggles. Maximum Panel Thickness with Standard Hardware: .193" (4.9mm)

Standard Hardware Supplied for Small Bushings

		Bushing Codes	S1/S4	A1	D1/D4	D3/D8	L1/L4	L3/L8
Hardware and Quantity	Hex Nut		2	2	2	1	2	1
	Locking Ring		1	1	0	0	1	0
	Lockwasher		1	1	1	0	1	0
	O-ring		0	0	0	1	0	1

For S1, S2, A1, A2 or S4 Bushing with Keyway & for L1 or L4 Bushing

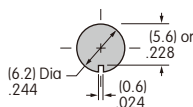

For S1, A1 or S4 Bushing with Locking Ring & for L1 or L4 Bushing

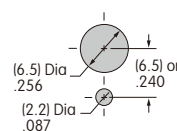

For D1, D4, D3 or D8 Bushing with D Flat & for L3 or L8 Bushing

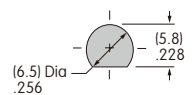

LARGE TOGGLES

Toggle & Bushing Combinations: These toggles combine with the 12mm bushings B1 & B3.

B .453" (11.5mm)
Large Bat

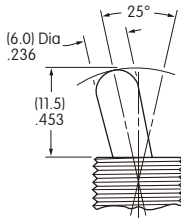

B2 .689" (17.5mm)
Large Bat

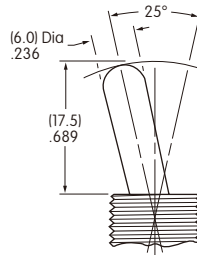

R .610" (15.5mm)
Large Flatted

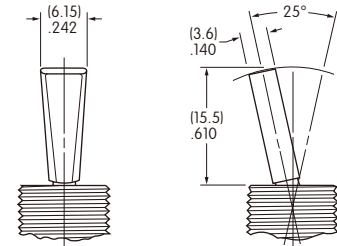

Standard Material & Finish: Brass with Bright Chrome

LARGE BUSHINGS

B1 Large .472" (12.0mm)
Threaded with Keyway

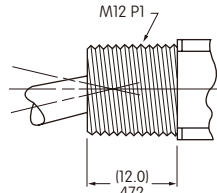
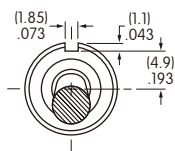

Maximum Panel Thickness with
Standard Hardware: .216" (5.5mm)

Standard Hardware for B1:
1 hex face nut AT503M, 1 locking ring AT506M,
1 lockwasher AT508, and 1 hex backup nut AT527M

B3 Large .472" (12.0mm)
Threaded Splashproof with D Flat

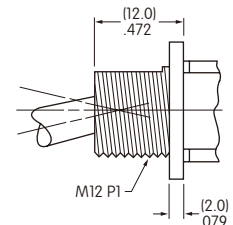
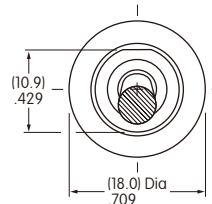

Maximum Panel Thickness with
Standard Hardware: .256" (6.5mm)

Standard Hardware for B3:
1 hex face nut AT503M
and 1 o-ring AT401P

Panel Cutouts

**For B1 Bushing
with Keyway**

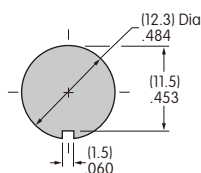

**For B1 Bushing
with Locking Ring**

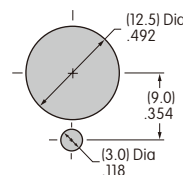

**For B3 Bushing
with D Flat**

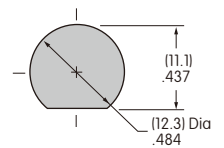

LOCKING LEVER & BUSHINGS

LL1 1/4-40 .291" (7.4mm)
Threaded with Keyway

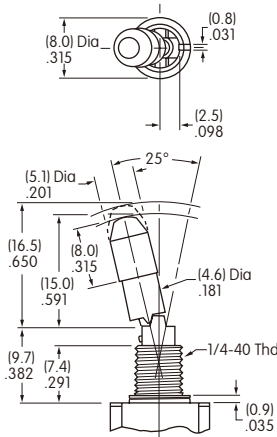

LL4 6mm/.291" (7.4mm)
Threaded with Keyway

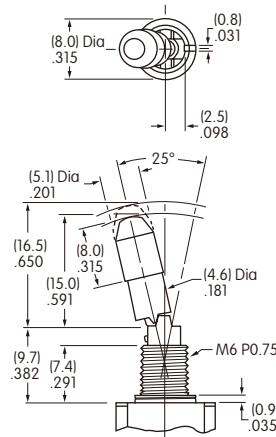

LL2 Smooth with Keyway

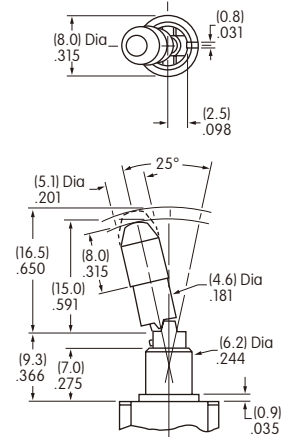

Maximum Panel Thickness with Standard Hardware: .047" (1.2mm)
Standard Hardware for L1 & L4: 2 hex nuts AT513H or AT513M,
1 locking ring AT507H or AT507M, and 1 lockwasher AT509

LL3 1/4-40 .295" (7.5mm)
Threaded Splashproof with D Flat

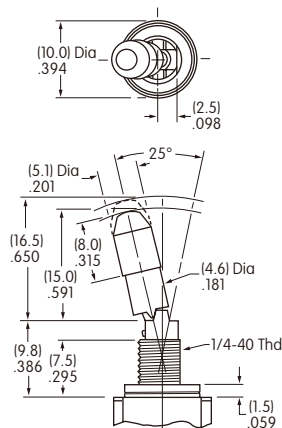

LL8 6mm/.295" (7.5mm)
Threaded Splashproof with D Flat

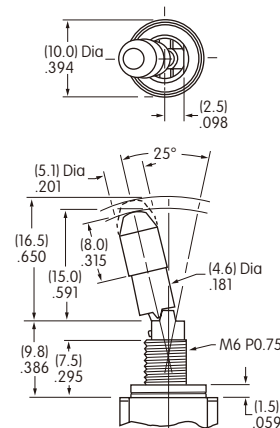

Maximum Panel Thickness with Standard Hardware: .047" (1.2mm)
Standard Hardware for L3 and L8: 1 hex nut AT513H or AT513M and 1 o-ring AT516

Lever Material & Finish: Brass with Chrome Plating

Locking Mechanism

on-none-on



2 positions lock

on-none-(on)



1 position locks

on-off-(on)
on-on-(on)



2 positions lock

on-off-on
on-on-on

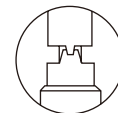

3 positions lock

(on)-off-(on)
(on)-on-(on)

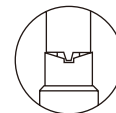

1 position locks

No Code

Supplied with Cap AT427

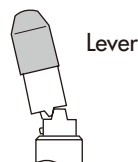

Lever

Color Codes for Optional Anodized Aluminum Caps

Cap Material:
Brass with Nickel Plating

A Black

C Red

G Blue

CONTACT MATERIALS & RATINGS

W	Silver over Silver	Power Level	6A @ 125V AC & 3A @ 250V AC
G	Gold over Brass or Copper	Logic Level	6A @ 125V AC & 3A @ 250V AC
Note: See Supplement section to find complete explanation of operating range.			
A	Gold over Silver	Power Level or Logic Level	6A @ 125V AC or 0.4VA maximum @ 28V AC/DC maximum
Note: This dual rated option is suitable when two or more identical switches are used in logic and in power circuits within the same application. See Supplement section to find complete explanation of dual rating and operating range.			

TERMINALS

01	Solder Lug		02	.062" (1.57mm) Wide Quick Connect		
03	.250" (6.35mm) Straight PC					
05	.409" (10.4mm) Wirewrap or Extended PC	07	.964" (24.5mm) Wirewrap or Extended PC		Dimension A = terminal lengths as shown beside the terminal codes at the left.	
06	.748" (19.0mm) Wirewrap or Extended PC	08	1.062" (27.0mm) Wirewrap or Extended PC			
If using as extended PC terminal, refer to the above footprints.						

OPTIONAL CAPS & CAP COLORS

B	* AT415 Lever Cap for S Bat Toggle Material: Polyethylene	C	* AT444 Conical Cap for S Bat Toggle Material: Polyethylene	R	AT434 Lever Cap for B Toggle Material: Polyvinyl Chloride	V	AT406 Lever Cap for B2 Toggle Material: Polyvinyl Chloride
* AT415 and AT444 for use with S toggles only, not S2 or S3 toggles.							

Cap Colors Available: **A** Black **B** White **C** Red **E** Yellow **F** Green **G** Blue

A Toggles
Rockers
Pushbuttons
Illuminated PB
Programmable
Keylocks
Rotaries
Slides
Tactiles
Tilt
Touch
Indicators
Accessories
Supplement

Toggles A
 Rockers
 Pushbuttons
 Illuminated PB
 Programmable
 Keylocks
 Rotaries
 Slides
 Tactiles
 Tilt
 Touch
 Indicators
 Accessories
 Supplement

TYPICAL SWITCH DIMENSIONS

Solder Lug

Single Pole

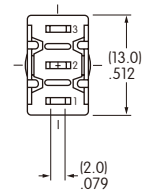
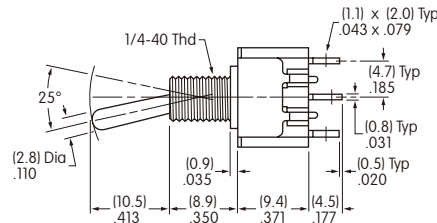
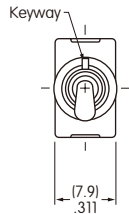

M2012SS1W01

M2011 model does not have terminal 1.

Solder Lug

Double Pole

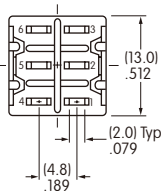
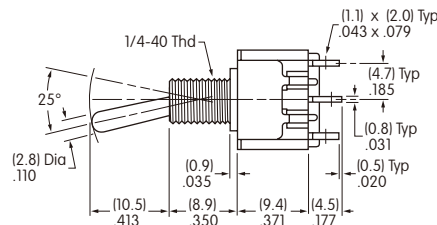
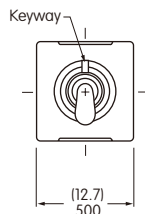

M2022SS1W01

M2021 model does not have terminals 1 & 4.

Solder Lug

Three Pole

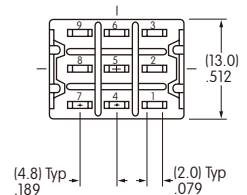
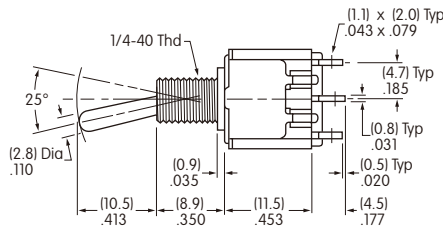
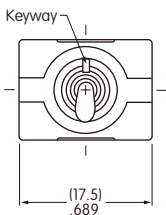

M2032SS1W01

Solder Lug

Four Pole

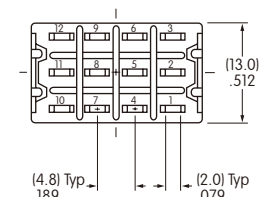
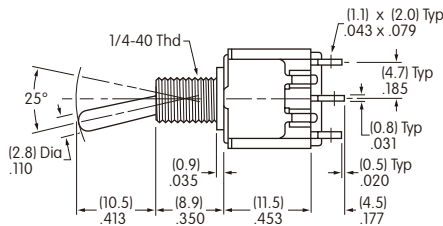
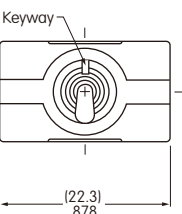

M2042SS1W01

STANDARD HARDWARE FOR SMALL & LARGE BUSHINGS

AT513H for Inch
AT513M for Metric
Hex Nut
Brass/Nickel

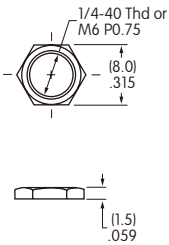

AT507H for Inch
AT507M for Metric
Locking Ring
Steel with Zinc/Chromate

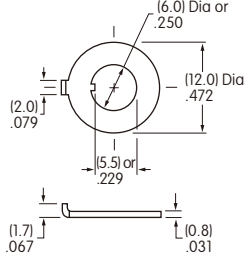

AT509
Lockwasher
Steel with Zinc/Chromate
(not supplied with splashproof models)

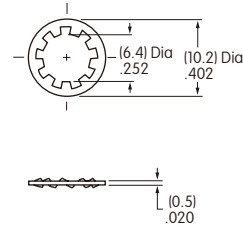

AT516
O-ring for Splashproof Models
Nitrile Butadiene Rubber

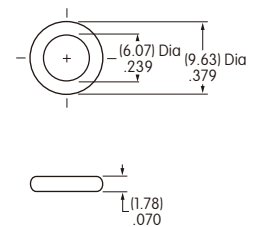

AT503M
Hex Face Nut
Brass/Chrome

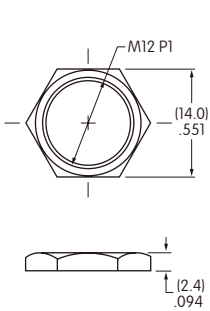

AT506M
Locking Ring
Steel with Zinc/Chromate

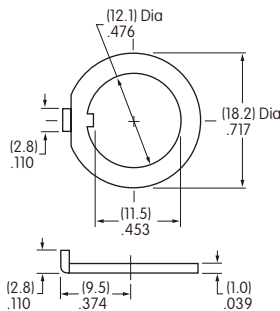

AT508
Lockwasher
Steel with Zinc/Chromate
(not supplied with splashproof models)

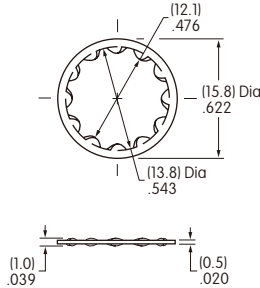

AT527M
Hex Nut
Steel with Nickel Plating

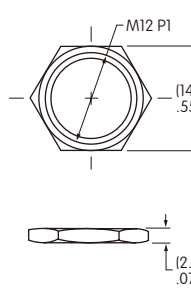

AT401P
O-ring for Splashproof Models
Nitrile butadiene rubber

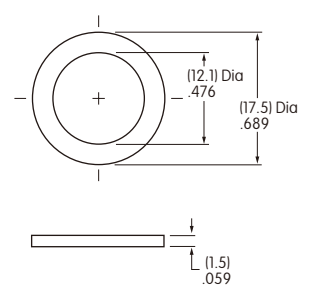

OPTIONAL SPLASHPROOF BOOTS

Various optional nuts and ON-OFF plates are available; dimensions are shown in the Accessories & Hardware section.

AT428 (M-metric H-Inch)
.445" (11.3mm)
Boot for S Toggle
Silicon Rubber

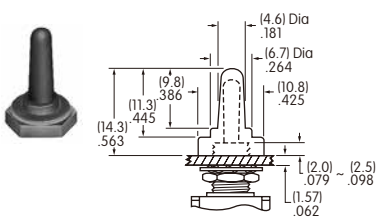

AT402
.760" (19.3mm)
Boot for B2 Toggle
Silicon Rubber

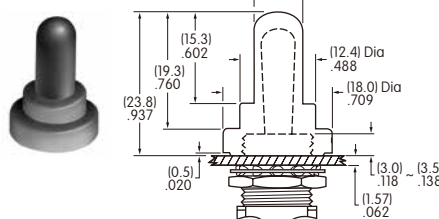

AT402S
.567" (14.4mm)
Boot for B Toggle
Silicon Rubber

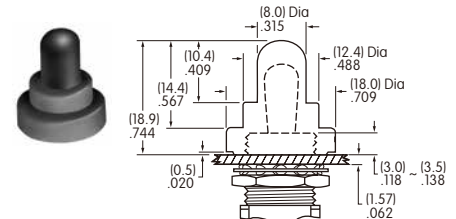

AT401
.461" (11.7mm)
Boot, Nut and O-ring for B2 Toggle
More details in Accessories section

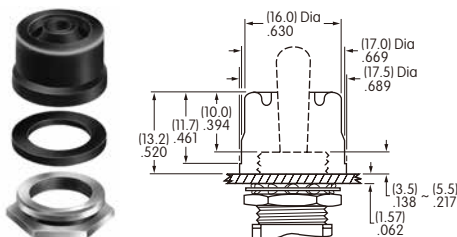

AT4181
.732" (18.6mm)
Boot, Nut and O-ring for B2 Toggle
More details in Accessories section

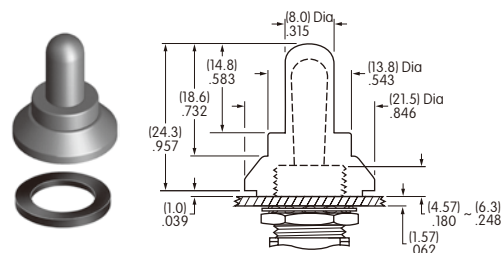

Toggles
Rockers
Pushbuttons
Illuminated PB
Programmable
Keylocks
Rotaries
Slides
Tactiles
Tilt
Touch
Indicators
Accessories
Supplement