

H Series

4 & 6 Tumbler Power Switchlocks

Features/Benefits

- Positive detent
- Multi-pole and multi-position
- Snap-together assembly
- Power switching

Typical Applications

- Machine controls
- Elevators

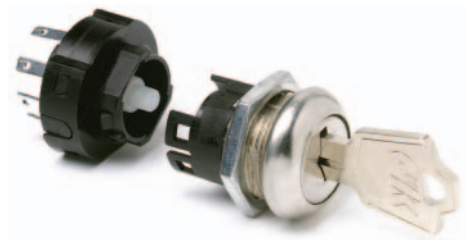

Models Available

Specifications

CONTACT RATING: Q contact material: 12 AMPS @ 125 V AC; 6 AMPS @ 250 V AC; 1 AMP @ 125 V DC (UL/CSA). See page M-42 for additional ratings.

ELECTRICAL LIFE: 10,000 make-and-break cycles at full load.

CONTACT RESISTANCE: Below 10 m Ω typ. initial @ 2-4 V DC, 100 mA, for both silver and gold plated contacts.

INSULATION RESISTANCE: 10⁹ Ω min.

DIELECTRIC STRENGTH: 1,000 Vrms min. @ sea level.

OPERATING TEMPERATURE: -30°C to 85°C.

INDEXING: 45° or 90°, 2-4 Positions.

NOTE: Any models supplied with Q or B contact material are RoHS compliant.

NOTE: Specifications and materials listed above are for switchlocks with standard options. For information on specific and custom switchlocks, consult Customer Service Center.

Materials

LOCK: Zinc alloy with stainless steel facing (4 tumbler locks and 6 tumbler tubular lock).

KEYS: Two nickel plated brass keys with code number (4 tumbler). Two die cast chrome plated zinc alloy keys (6 tumbler).

SWITCH HOUSING: 6/6 nylon (UL 94V-2).

CONTACTS & TERMINALS: Q contact material: Copper, silver plated. See page L-42 for additional contact materials.

CONTACT SPRING: Music wire or stainless steel.

MOUNTING NUT: Zinc alloy.

MOUNTING CLIP: Steel, zinc plated.

DRESS NUT: Brass, nickel plated.

TERMINAL SEAL: Epoxy.

Build-A-Switch

To order, simply select desired option from each category and place in the appropriate box. Available options are shown and described on pages L-40 through L-42. For additional options not shown in catalog, consult Customer Service Center.



Switch and Lock Function

- H10113** SP, 90° Index, keypull pos.1
- H2011U** DP, 90° Index, keypull pos. 1 & 2
- H100AA** SP, 45° Index, keypull pos. 1,2 & 3
- H200AA** DP, 45° Index, keypull pos. 1, 2 & 3
- H20113** DP, 90° Index, keypull pos. 1
- H1011U** SP, 90° Index, keypull pos.1 & 2
- H1417U** SP, 90° Index, keypull pos. 1,2 & 3

Keying

- 2** Two nickel plated brass keys (4 tumbler) or two die cast zinc alloy keys with chrome plating (6 tumbler)
- T** One nickel plated brass key with plastic insert molded square head and one nickel plated brass key

Lock Type

- F** 4 Tumbler lock with detent
- V** 6 Tumbler tubular lock

Lock Finish

- 2** Stainless steel facing
- 8** Gloss black facing

Terminations

- 05** Quick connect
- WC** Wire lead

Mounting/Lock Style

- N** With nut
- D** With clip

Contact Material

- Q** Silver
- B** Gold

Key Color

- NONE** Nickel plated brass (4 tumbler) or chrome plated zinc alloy (6 tumbler)
- 2** Black



Switchlock



H Series 4 & 6 Tumbler Power Switchlocks

SWITCH AND LOCK FUNCTION

| NO. TUMBLERS | NO. POLES | MODEL NO. | CONNECTED TERMINALS | | | | KEY PULL POSITIONS | LOCK CONFIGURATION | INDEXING |
|--------------|-----------|--------------------------------|---------------------|-----------------|-----------------|--------|--------------------|--------------------|----------|
| | | | POS. 1 | POS. 2 | POS. 3 | POS. 4 | | | |
| 4 | SP DP | H100AA H200AA | 7-8 7-8, 3-4 | 8-1 8-1, 4-5 | 6-7 6-7, 2-3 | | Positions 1, 2 & 3 | | 45° |
| 4 & 6 | SP DP | H10113 H20113 | 7-8 7-8, 3-4 | 8-2 8-2, 4-6 | | | Position 1 | | |
| 4 & 6 | SP DP | H1011U H2011U | 7-8 7-8, 3-4 | 8-2 8-2, 4-6 | | | Positions 1 & 2 | | 90° |
| 4 | SP | H1417U | 6-8 | 8-2 | 5-6 | | Positions 1, 2 & 3 | | |

All models  with all options when ordered with 'G' or 'Q' contact material.

TERMINAL NUMBERS

LEGEND

- = Detent Positions (45° or 90°)
- ⊙ = Key pull possible in these positions.
- ⊙ = Stop Positions

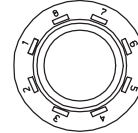

Terminal numbers molded on housing.

4 Tumbler

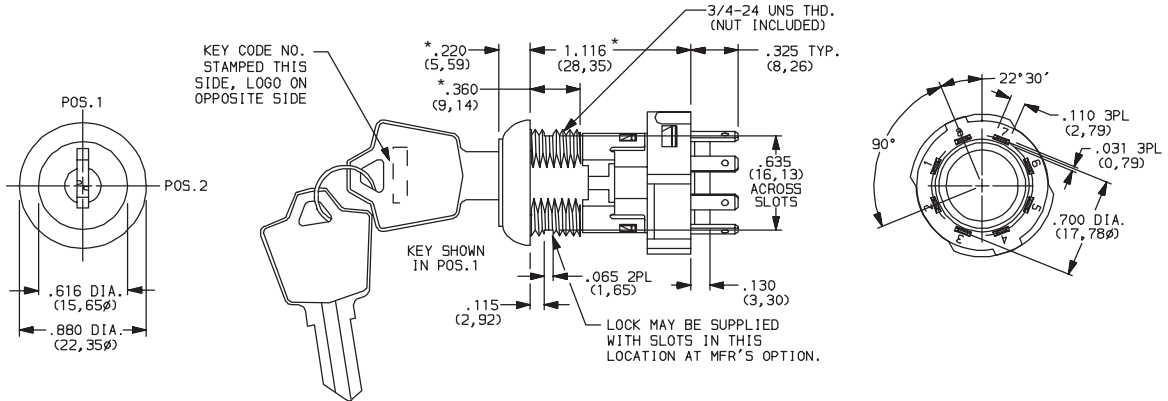

Part number shown: H101132F205NQ

6 Tumbler

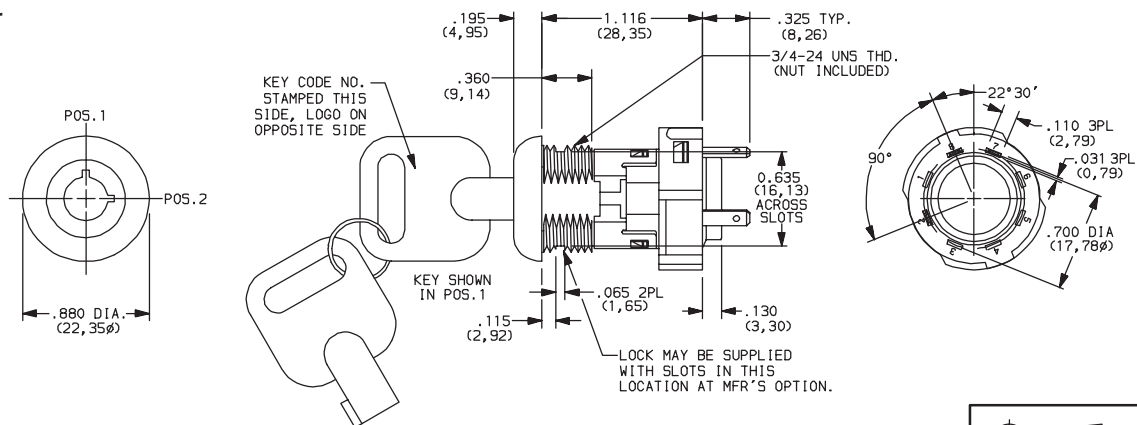

Part number shown: H1011U2V205NQ



Dimensions are shown: Inch (mm)
Specifications and dimensions subject to change



H Series 4 & 6 Tumbler Power Switchlocks

KEYING

| OPTION CODE | KEY OPTIONS | CODE NO. ON KEY | CODE NO. ON LOCK |
|-------------|--|-----------------|------------------|
| 2 | 2 NICKEL PLATED BRASS KEYS (4 TUMBLER) OR 2 CHROME PLATED ZINC ALLOY KEYS (6 TUMBLER) | YES | NO |
| T | 1 NICKEL PLATED BRASS KEY WITH PLASTIC INSERT MOLDED SQUARE HEAD & 1 NICKEL PLATED BRASS KEY | YES | NO |

| OPTION CODE | KEY COLOR |
|-------------|---|
| NONE | NICKEL PLATED BRASS (4 TUMBLER) OR CHROME PLATED ZINC ALLOY (6 TUMBLER) |
| 2 | BLACK |

NOTE: All orders keyed alike, standard. For more than one key code, replacement keys, or other special features, consult Customer Service Center.

NICKEL PLATED BRASS KEY

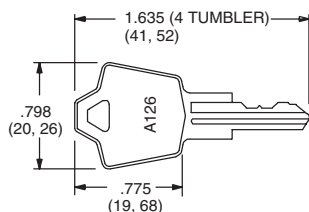

Key part number: 115140126

NICKEL PLATED BRASS KEY WITH PLASTIC INSERT MOLDED SQUARE HEAD

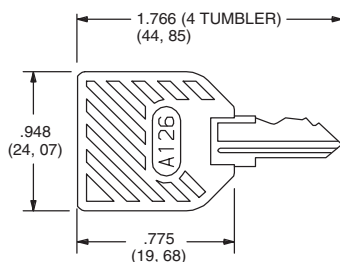

Key part number: 11599112602

CHROME PLATED ZINC ALLOY KEY

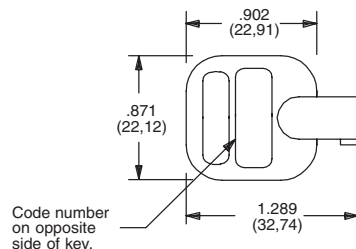

Key part number: 363C1AAAA

NOTE: Key head shape subject to change without notice.

LOCK TYPE

F 4 TUMBLER LOCK WITH ADDED DETENT

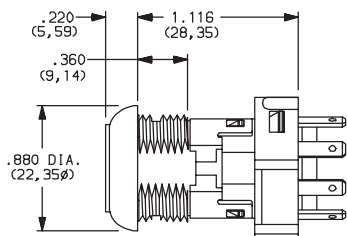

V 6 TUMBLER TUBULAR LOCK

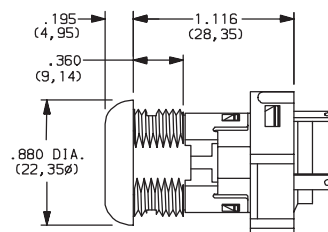

LOCK FINISH

2 STAINLESS STEEL FACING



Available with V lock type only.

8 GLOSS BLACK FACING



Switchlock

TERMINATIONS

05 .110" QUICK CONNECT

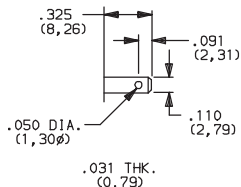

WC WIRE LEAD

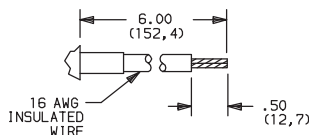

Black wire standard, other colors, gages and lengths available, consult Customer Service Center. UL style 1015.



Dimensions are shown: Inch (mm)
Specifications and dimensions subject to change



H Series 4 & 6 Tumbler Power Switchlocks

MOUNTING/LOCK STYLE

N WITH NUT

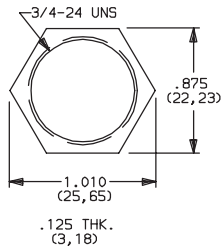

Nut part number: 175050700

D WITH CLIP

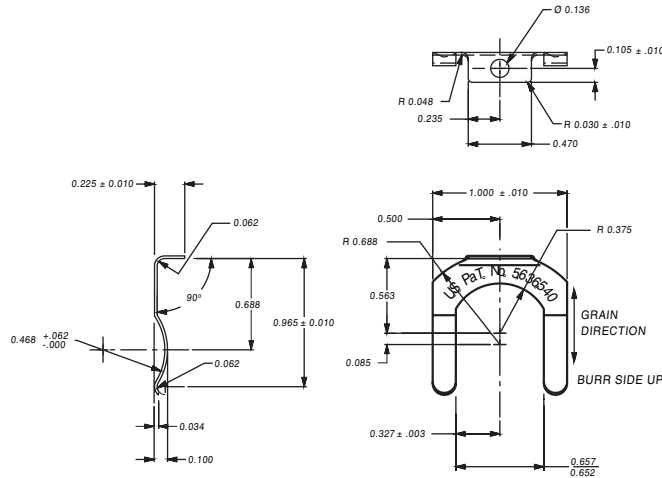

Clip part number: 906B00000

PANEL MOUNTING

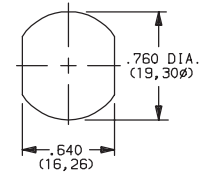

| MOUNTING STYLES | PANEL THICKNESS |
|-----------------|-----------------------|
| D | .065-.085 (1,65-2,16) |
| N | .195 (4,95) max. |

Switch and Lock Assembly Instructions

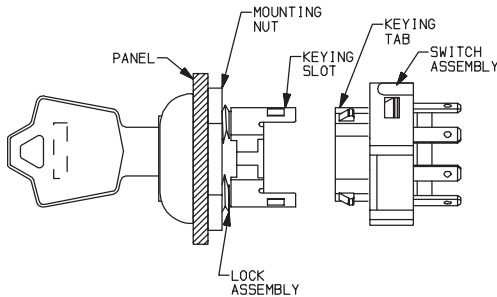

1. Place lock assembly in mounting hole on panel, secure with mounting nut.
2. Align keying tab on switch assembly with keying slot on lock assembly.
3. Snap assemblies together.
4. Switch installation is permanent. Switch cannot be removed from lock after assembly. Attempting to separate switch and lock may cause damage to switchlock.

CONTACT MATERIAL

| OPTION CODE | RoHS COMPLIANT* | RoHS COMPATIBLE* | CONTACT AND TERMINAL MATERIAL | RATING | |
|-------------|-----------------|------------------|-------------------------------|-----------------------|---|
| | | | | POWER | 12 AMPS @ 125 V AC; 6 AMPS @ 250 V AC; 1 AMP @ 125 V DC (UL/CSA). |
| Q | YES | YES | SILVER ² | LOW LEVEL/DRY CIRCUIT | 0.4 VA MAX. @ 20 V AC or DC MAX. |
| B | YES | YES | GOLD ¹ | | |

¹ CONTACTS & TERMINALS: Copper, with gold plate over nickel plate.
² CONTACTS & TERMINALS: Copper, silver plated.

* Note: See Technical Data section of this catalog for RoHS compliant and compatible definition and specifications.

All models  with all options when ordered with 'Q' contact material.



Third Angle Projection

Dimensions are shown: Inch (mm)
 Specifications and dimensions subject to change



H Series 4 & 6 Tumbler Power Switchlocks

AVAILABLE HARDWARE



Key Code: A126
4 TUMBLER
PART NO. (ONE KEY)
115140126
Material: Brass
Finish: Nickel plate



Key Code: AAAA
PART NO. (ONE KEY)
363C1AAAA

Material: Zinc Alloy
Finish: Chrome plate

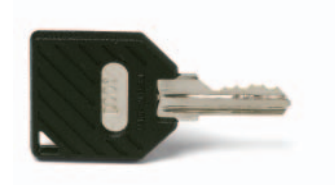

Key Code: A126
4 TUMBLER
PART NO. (ONE KEY)
1159112602 BLACK

Material: Brass
Finish: Nickel plate
6/6 Nylon insert molded head



Switchlock