



Every part matters

EN

Installation & Operating Instructions DIGITAL MULTIFUNCTION INSTRUMENT RS Pro 1line - 20mm DISPLAY

Article codes

136-5379 Digital Multi-Function Meter 1 Line Display, 96x96, 3Ph, V A F, with Limit Relay/Switch option

1. Introduction

The RS Pro 1 Line is a panel mounted 96 x 96mm DIN Quadratic Digital Panel Meter for the measurement of important electrical parameters like AC Voltage, AC Current, RPM, Frequency.

The instrument integrates accurate measurement technology (All Voltages & Current measurements are True RMS upto 15th Harmonic) with 1 line 4 digits Ultra high brightness LED display with 20mm Digit height.

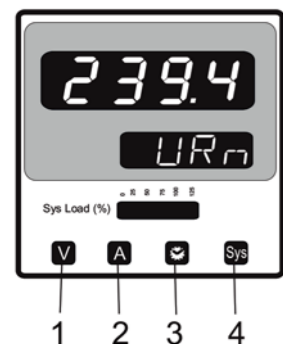

RS Pro can be configured and Programmed at site for the following : PT Primary, PT Secondary, CT Primary, CT Secondary (5A or 1A) and System Type 3 phase 3W or 4W or single phase system.

The front panel has four push buttons for user interface to scroll through the available parameters the four keys has function as follow :

1. V : Selects & Scrolls through Voltage parameter Display
2. A : Select phase Current Parameters Display.
3. Sys : Select & Scrolls through Time parameters : On hr, Run Hr & number of Aux. Supply interruptions.

4. Sys : Select & Scroll through System parameters : Voltage, Current, Frequency, max and min Values.

The RS Pro 1 line come with 20mm display which enables to take reading from long distance. The Alphanumeric Display is readable from long distance which overcomes the problem with LED annunciators that could not be clearly understood the parameter being Displayed.

The Bar graph is an advantage to monitor load level on feeders / generators on which the RS Pro is installed.

TABLE 1:

Measured Parameters	Units of measurement
System Voltage	Volts
Frequency	Hz
Voltage VL1-N(4wire only)	Volts
Voltage VL2-N(4wire only)	Volts
Voltage VL3-N(4wire only)	Volts
Voltage VL1-L2	Volts
Voltage VL2-L3	Volts
Voltage VL3-L1	Volts
Current L1	Amps
Current L2	Amps
Current L3	Amps
RPM measurement	RPM
Max. Value System Voltage	V
Max. Value System Current	A
Min. Value System Voltage	V
Min. Value System Current	A
Run Hours	Hrs
ON Hours	Hrs
No.of Auxiliary Interrupts	---- (Counts)

2. Measurement Reading Screens

In normal operation the user is presented with the measurement reading screens These screens may be scrolled through one at a time in incremental order by pressing the "A" key for Currents, "V" key for Voltages, "Sys" key for RPM, Run Hour, ON hour, No. of interruptions and "Sys" key for System Voltage, System Current, Frequency, max values and min. values.

Screen 1 : Voltage R Phase (For 1Ph and 3P4 Wire only)



Screen 2 : Voltage Y Phase (For 3P4 wire only)



Screen 3 : Voltage B Phase (For 3P4 wire only)

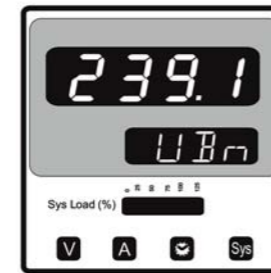

Screen 4 : Line to Line Voltage (Voltage between R and Y phase)



Screen 5 : Line to Line Voltage (Voltage between Y and B phase)



Screen 6 : Line to Line Voltage (Voltage between B and R phase)



Screen 7 : R Phase Current



Screen 8 : Y Phase Current

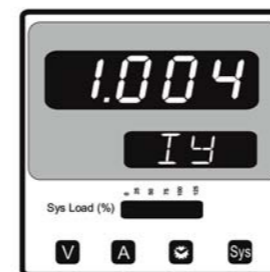

Screen 9 : B Phase Current

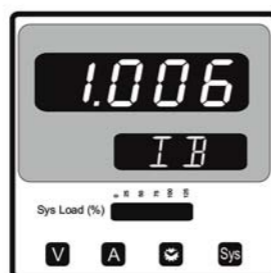

Screen 10 : RPM Measurement



Screen 11 : Run Hours



Screen 12 : ON Hours



Screen 13 : No. of Aux. Interruptions



Screen 14 : System Voltage



Screen 15 : System Current

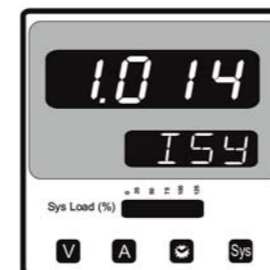

Screen 16 : System Frequency

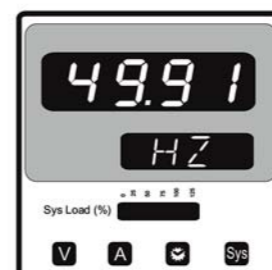

Screen 17 : System Voltage max. Value

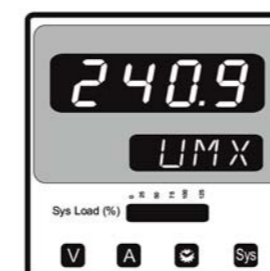

Screen 18 : System Current max. Value

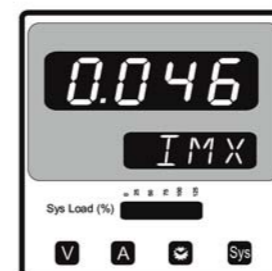

Screen 19 : System Voltage min. Value

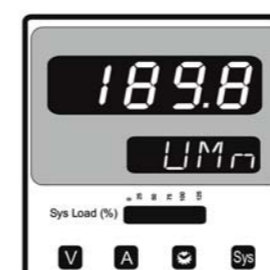

Screen 20 : System Current min. Value



3. Programming

The following sections comprise step by step procedures for configuring the RS Pro 1 Line for individual user requirements.

To access the set-up screens press and hold the "V" and "A" Keys Simultaneously. This will take the User into the Password Entry Screen (Section 3.1)

3.1. Password Protection

Password protection can be enabled to prevent unauthorised access to set-up screens, by default password protection is not enabled.

Password protection is enabled by selecting a four digit number other than 0000, setting a password of 0000 disables the password protection.

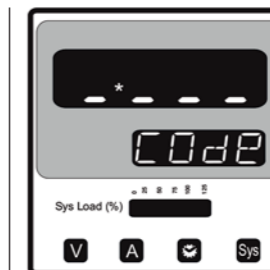

Enter Password, prompt for first digit.

(* Denotes that decimal point will be flashing).

Press the "V" key to scroll the value of the first digit from 0 to 9, the value will wrap from 9 round to 0.

Press the "A" key to advance to next digit.

In the special case where the Password is "0000" pressing the "A" key when prompted for the first digit will advance to the "Password Confirmed" screen.

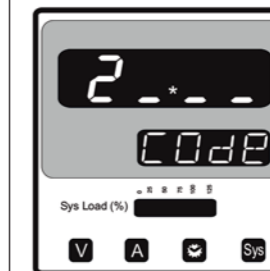

Enter Password, first digit entered, prompt for Second digit.

(* Denotes that decimal point will be flashing).

Use the "V" key to scroll the value of the second digit from 0 through to 9, the value will wrap from 9 round to 0.

Press the "A" key to advance to next digit.

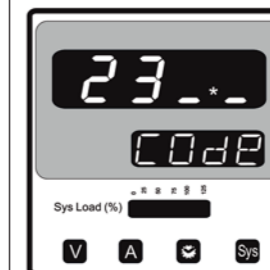

Enter Password, second digit entered, prompt for Third digit.

(* Denotes that decimal point will be flashing).

Use the "V" key to scroll the value of the second digit from 0 through to 9, the value will wrap from 9 round to 0.

Press the "A" key to advance to next digit.

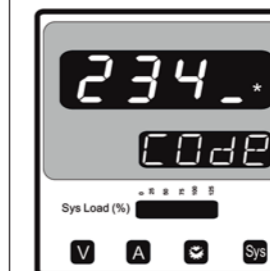

Enter Password, third digit entered, prompt for Fourth digit.

(* Denotes that decimal point will be flashing).

Use the "V" key to scroll the value of the second digit from 0 through to 9, the value will wrap from 9 round to 0.

Press the "A" key to advance to next digit.

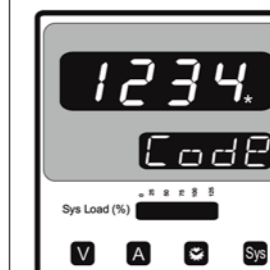

Enter Password, fourth digit entered, awaiting verification of the password.

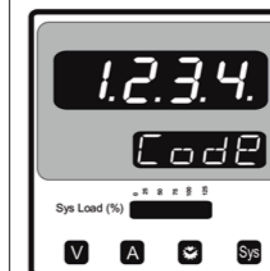

Password confirmed.

Pressing "V" key will advance to the "New Password / change Password" entry stage.

Pressing the "A" key will advance to the menu Selection screen. (See section 3.2).



Password Incorrect.

The unit has not accepted the Password entered.

Pressing the "V" key will return to the Enter Password stage.

Pressing the "A" key exits the Password menu And returns to the Measurement mode.



New / Change Password ("Decimal point indicates that this will be flashing).

Pressing the "V" key will scroll the value of the first digit from 0 through to 9, the value will wrap from 9 round to 0.

Pressing the "A" key to advance the operation to the next digit and sets the first digit.



New / Change Password, first digit entered, prompting for second digit. ("Decimal point indicates that this will be flashing).

Pressing the "V" key will scroll the value of the Second digit from 0 through to 9, the value will wrap from 9 round to 0.

Pressing the "A" key to advance the operation to the next digit and sets the second digit,



New / Change Password, second digit entered, prompting for third digit. ("decimal point indicates that this will be flashing).

Pressing the "V" key will scroll the value of the third digit from 0 through to 9, the value will wrap from 9 round to 0.

Pressing the "A" key to advance the operation to the next digit and sets the third digit,



New / Change Password, third digit entered, prompting for fourth digit. (* denotes that decimal point will be flashing).

Pressing the "V" key will scroll the value of the fourth digit from 0 through to 9, the value will wrap from 9 round to 0.

Pressing the "A" key to advance the operation to the "New Password Confirmed" and sets the fourth digit,



New Password confirmed.

Pressing the "V" key will return to the "New/Change Password".

Pressing the "A" key will advances to the Set up screen.(see section 3.2).

3.2 Set Up Screens

3.2.1. System Type

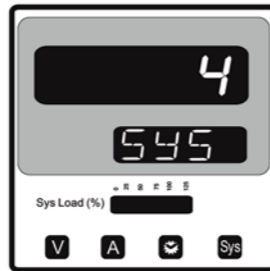

This screen is used to set the system type. System type "3" for 3 phase 3 wire & "4" for 3 phase 4 wire system & 1 for Single ph system.

Pressing "A" key accepts present value and Advances to the "Potential transformer Primary . Value Edit" menu

Pressing "V" Key will enter the System type edit Mode and scroll the values through values available.

Pressing "A" Key advances to the system type Confirmation menu.



System Type Confirmation

This screen will only appear following the edit of system type.

Pressing the "A" key set the displayed value and will advance to "Potential Transformer Primary Value Edit" menu. (See section 3.2.2)

3.2.2. Potential Transformer Primary Value

The nominal full scale voltage which will be displayed as the Line to Line voltage for all system types. This screen enables the user to display Line to Line and Line to neutral Voltages inclusive of any PT ratios, the values displayed represent the voltage in kV.



Pressing the "A" key accepts the present value and advances to the "Current Transformer Primary value Edit" menu. (See Section 3.2.3)

Pressing the "V" key will enter the "Potential transformer Primary Value Multiplier Selection edit mode.

Initially the "multiplier must be selected. Pressing the "V" Key will move the decimal point position to the right side Until it reaches ###.# after which it will return to #.###

Pressing the "A" key accepts the present multiplier (Decimal Point position) and advances to the "Potential Transformer Ratio Edit" mode.

Note : PT Values must be set as Line to Line Voltage for Primary as well as Secondary for all system types.(i.e for 3p4w,3p3w & 1p2w)

Potential Transformer Digit Edit

Pressing the "V" key will scroll the value of the most significant digit from 0 through to 9 unless the presently displayed Potential Transformer Primary value together with the Current Transformer Primary value previously Set, would result in a maximum power of greater than 1000 MVA per phase in that case the digit range will be Restricted.

Pressing the "A" key accepts the present value at The cursor position and advances the cursor to the next Less significant digit.

Note : the flashing decimal point indicates the cursor position, a steady decimal point will be present to identify the scaling of the number until the cursor position coincides with the steady decimal point position. At this stage the decimal point will flash.

When the least significant digit has been set, pressing the "A" key will advance to the "Potential transformer Primary Value Confirmation" stage.

Screen showing display of 11.00 kV i.e. 1100 Volts indicating steady decimal point and cursor flashing at the "hundreds of volts" position as shown below.

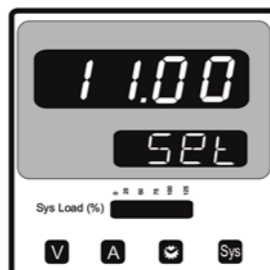

Potential Transformer Primary Value Confirmation

This screen will only appear following an edit of the Potential Transformer Primary Value.

If the set value is to be corrected, pressing the "V" key will return to the "Potential Transformer Primary Value Edit" stage with the digits flashing indicating that the Multiplier (decimal point position) should be selected.

Pressing the "A" key sets the displayed value Will advance to the Current Transformer Primary. Value (See section 3.2.3.)

3.2.3. Current Transformer Primary Value

The nominal Full Scale Current that will be displayed as the Line currents. This screen enables the user to display the Line currents inclusive of any transformer ratios, the values displayed represent the Current in Amps.

Pressing the "A" key accepts the present value and advances to the Potential Transformer Secondary Value edit screen (See section 3.2.4)

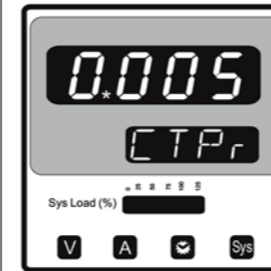

Pressing the "V" key will enter the "Current Transformer

Primary Value Edit" mode.

Pressing the "A" key will accept the present value and"

Advances to the "Potential Transformer Secondary Value edit" mode.

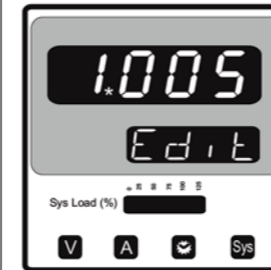

Current Transformer Primary value Edit

Pressing "V" key will advance the Most Significant Digit from 0 through to 9, unless Current Transformer

Primary Value together with the Potential Transformer Primary Value results in a maximum power of greater than 1000 MVA in which case the digit range will be Restricted, the value will wrap. Example: If primary value of PT is set as 692.8kVL-L (max value) then primary value of Current is restricted to 1736A.Pressing the "A" key will advance to the next less significant digit. (* Denotes that decimal point will be flashing).

The "Maximum Power" restriction of 1000 MVA refers to 120% of nominal current and 120% of nominal voltage, i.e. 694.4 MVA nominal power per phase.

When the least significant digit had been set, pressing the "A" key will advance to the "Current Transformer Primary Value Confirmation" stage.

The minimum value allowed is 1, the value will be forced to 1 if the display contains zero when the "A" key is pressed.

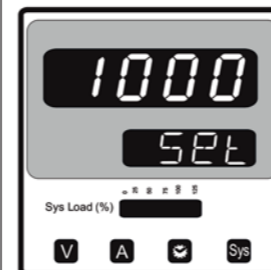

Current Transformer Primary Value Confirmation.

This screen will appear following an edit of the Current Transformer Primary Value.

If the scaling is not correct, Pressing the "V" key will return to the "Current Transformer Primary Value Edit" stage.

Pressing the "A" key sets the displayed value and then advance to the "Potential Transformer Secondary Value Edit" menu. (See section 3.2.4).

3.2.4. Potential Transformer Secondary Value

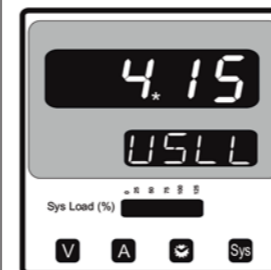

This screen is used to set the secondary value for Potential Transformer. Secondary value from 100V To 500VL-L.

Pressing A" key accepts the present value and then Advances to Current Transformer Secondary value Edit mode.

Pressing the "V" key will enter the CT secondary value edit mode and scroll through the values available.

Pressing the "A" key will advance to the CT Secondary value confirmation.

Potential Transformer Secondary value Edit

Pressing "V" Key advances the Most Significant Digit

To scroll from 1 through 5 .Pressing "A" shifts the Decimal Position to right.

When Value of least significant Digit is set, Pressing of "A" key advances the screen to "PT secondary value

Confirmation" Screen.

Set the secondary value as per following ranges for better Accuracy Results :

Input Voltage Range (VL-L)	PT Secondary Range to be set (VL-L)
0 -125V	100V - 125 V
126V - 250 V	126V - 250 V
251V - 500 V	251V - 500 V

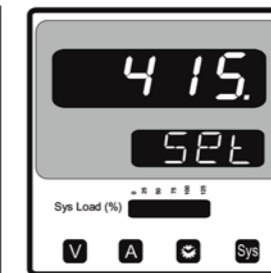

PT Secondary value confirmation

This screen will only appears following an edit of PT secondary value.

If secondary value shown is not correct, pressing the "V" key will return to PT secondary edit stage.

Pressing "A" key sets the displayed value and will advance to CT Secondary Value Edit menu. (See section 3.2.5)

3.2.5. Current Transformer Secondary Value

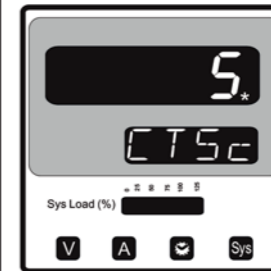

This screen is used to set Current Transformer Secondary Value.

Possible Values for CT Secondary are 1 and 5A.

Pressing "A" key Accepts present Value and advances to RESET menu.

Pressing "V" will enter the CT Secondary Edit menu.

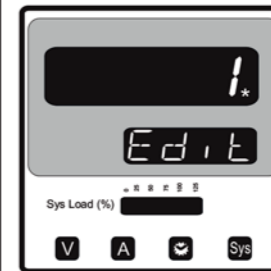

Current Transformer Secondary Value Edit

Pressing "V" will Scroll Value between 1 and 5

Pressing "A" will enter the CT Secondary Value Confirmation menu.

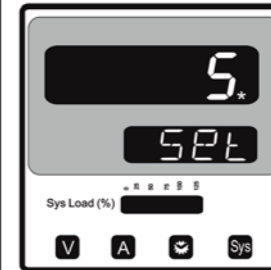

CT Secondary Value Confirmation

Pressing "V" will enter CT Secondary Value Edit menu.

Pressing "A" will Accept present Value and advance to RESET menu.

3.2.6. Resets

The following screens allow the users to reset the run hour, ON Hour, No. of interruptions, Min and Max. Values of Voltage and Current.

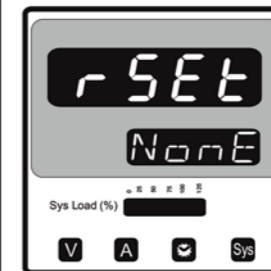

Pressing "V" key scrolls the Parameters for Reset and Pressing "A" enters parameter Reset Confirmation.

Pressing the "V" key will enter the "Reset" option and scroll from None, All, Max, Min, Hour and back to None.

Pressing the "A" key will enter Reset confirmation screen.

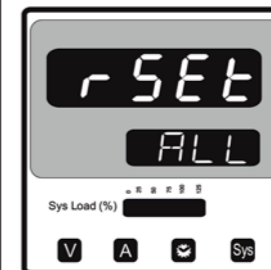

Reset of All parameters

Pressing the "A" key will enter Reset confirmation Screen.

Pressing "V" will scroll to max parameter

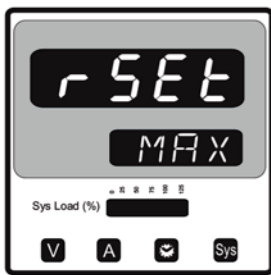

Reset (Max) values of System Voltage and Current.
Pressing the "A" key will enter Reset confirmation screen. Pressing "V" key will scroll to min Values.

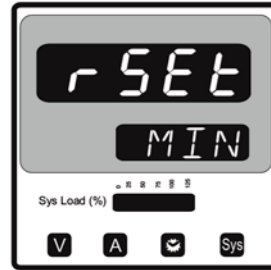

Reset (min) values of System Voltage and Current.
Pressing the "A" key will enter Reset confirmation screen. Pressing "V" key will scroll to Hour Values.



Reset Hour values of On ,Run and No. of interruptions
Pressing the "A" key will enter Reset confirmation screen.
Pressing "V" key will scroll to "None".

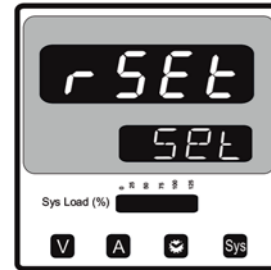

Confirmation of parameter for RESET
Pressing "A" key will Reset the Selected Parameter. And then enter to Screen Auto and manual scroll selection menu.
Pressing "V" will enter reset menu back and scroll between parameters as above.

3.2.7 Screen Auto/manual scrolling selection

This menu allow to select scrolling or fixed Screen



Auto Scrolling Edit
Pressing "A" enters confirmation of Fixed Screen.
Pressing of "V" key scrolls to "Volt" parameters
Scrolling selection menu



Selection of All parameters in Auto Scrolling
Pressing "A" enters confirmation of all the display Parameters screen.
Pressing of "V" key enters to "Current" parameters Scrolling selection menu



Selection of Current parameters in Auto Screen
Pressing "A" will enters confirmation of Current Parameters in Auto scrolling
Pressing "V" will scroll to Hour parameter set Menu.

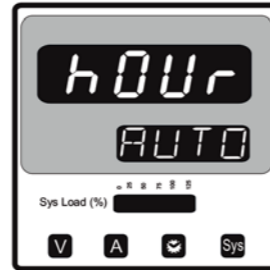

Selection of hour parameters in Auto Screen
Pressing "A" will enters confirmation of hour Parameters in Auto scrolling : Run hour, ON hour.No. Of interruptions.

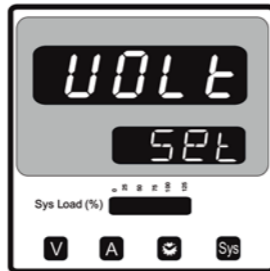

Confirmation of Auto scrolling parameters or fixed Screen.
Pressing "A" key will set the Parameter on screen As Auto scrolling, in this case, Voltage parameters. and then it will enter the No. of pole selection menu.
Pressing "V" will wrap the menu back to None.

3.2.8 No. of Poles Selection

This screen enables to Set No. of poles of a Generator of which RPM is to be measured.

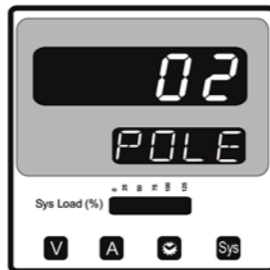

Selection of No. of poles of the Generator
Pressing "V" enter into no. of pole edit menu and Scrolls the number from 02 to 40 in step of 2. After 40 it wraps to the number again 02.

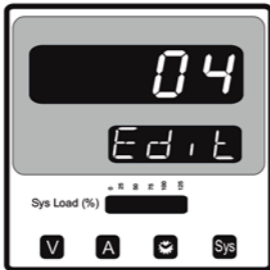

No. of poles edit
Pressing "V" scrolls the number from 02 to 40 in step of 2.
After 40 it wraps to the number again 02.
Pressing "A" enters into No. Of poles Confirmation Screen



No. of poles Confirmation
Pressing "V" enters back to No. of poles edit Menu.
Pressing "A" sets the number on screen, 4 in this Case, as number of poles of generator.

4. Run Hours



This screen shows the total no. Of hours the Load is connected. Even if the Auxiliary supply is interrupted, count of Run hour will be maintained In internal memory & displayed in the format "Hours". For example, if displayed count is 0258, then it indicates 258 hours.
After 9999 count of run hours, display will start again from zero.
To reset run hour count manually, see section Reset (3.2.6).

5. ON Hours



This screen shows the total no. of hours the Auxiliary supply is ON. Even if the Auxiliary supply is interrupted, count of ON hour will be maintained In internal memory & displayed in the format "Hours". For example, if displayed count is 0308, then it indicates 308 hours.
After 9999 count of ON hours, display will Start again from zero.
To reset ON hour count manually, see section Reset (3.2.6).

6. Number of interruptions

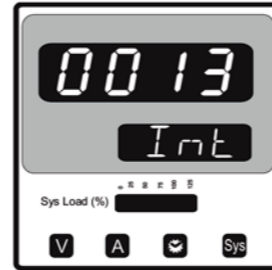

This screen displays the total no. Of times the auxiliary supply was interrupted. Even if the auxiliary Supply is interrupted, the count will be maintained In internal memory.
To reset No. of interruptions count manually, see section Reset (3.2.6).

7. Installation

Mounting of RS Pro is featured with easy "Clip- in" mounting. Push the meter in panel slot (size 92 x92 mm), it will click fit into panel with the four integral retention clips on two sides of meter.

If required Additional support is provided with swivel screws (optional) as shown in figure.

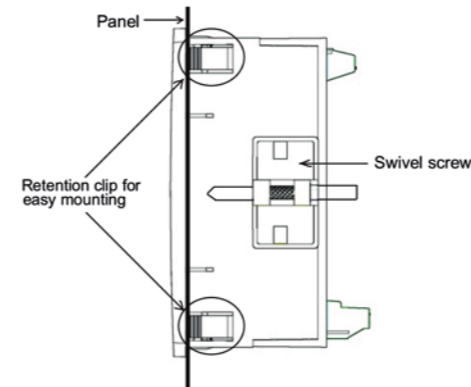

As the front of the enclosure conforms to IP50 it is protected from water spray from all directions, additional protection to the panel may be obtained by the use of an optional panel gasket. The terminals at the rear of the product should be protected from liquids.

The RS Pro 1 Line should be mounted in a reasonably stable ambient temperature and where the operating temperature is within the range 0 to 50 C . Vibration should be kept to a minimum and the product should not be mounted where it will be subjected to excessive direct sunlight.

Caution

- In the interest of safety and functionality this product must be installed by a qualified engineer, abiding by any local regulations.
- Voltages dangerous to human life are present at some of the terminal connections of this unit. Ensure that all supplies are de-energised before attempting any connection or disconnection.
- These products do not have internal fuses therefore external fuses must be used to ensure safety under fault conditions.

7.1 EMC Installation Requirements

This product has been designed to meet the certification of the EU directives when installed to a good code of practice for EMC in industrial environments, e.g.

- Screened output and low signal input leads or have provision for fitting RF suppression components, such as ferrite absorbers, line filters etc., in the event that RF fields cause problems.

Note: It is good practice to install sensitive electronic instruments that are performing critical functions, in EMC enclosures that protect against electrical interference which could cause a disturbance in function.

- Avoid routing leads alongside cables and products that are, or could be, a source of interference.
- To protect the product against permanent damage, surge transients must be limited to 2kV pk. It is good EMC practice to suppress differential surges to 2kV at the source. The unit has been designed to automatically recover in the event of a high level of transients. In extreme circumstances it may be necessary to temporarily disconnect the auxiliary supply for a period of greater than 5 seconds to restore correct operation.

The Current inputs of these products are designed for connection in to systems via Current Transformers only, where one side is grounded.

- ESD precautions must be taken at all times when handling this product.

7.2 Case Dimension and Panel Cut Out

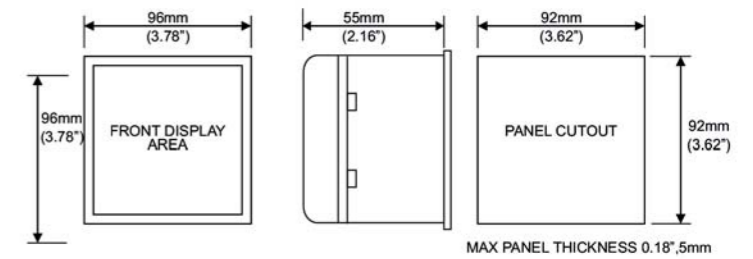

7.3 Wiring

Input connections are made directly to screw-type terminals with indirect wire pressure. Numbering is clearly marked on the connector. Choice of cable should meet local regulations. Terminal for both Current and Voltage inputs will accept upto 4mm²(12 AWG) or 2.5mm²(12 AWG)Standard .

Note : It is recommended to use wire with lug for connection with meter.

7.4 Auxiliary Supply

RS Pro 1 Line should ideally be powered from a dedicated supply, however it may be powered from the signal source, provided the source remains within the limits of the chosen auxiliary voltage.

7.5 Fusing

It is recommended that all voltage lines are fitted with 1 amp HRC fuse.

7.6 Earth/Ground Connections

For safety reasons, CT secondary connections should be grounded in accordance with local regulations.

8. Connection Diagrams

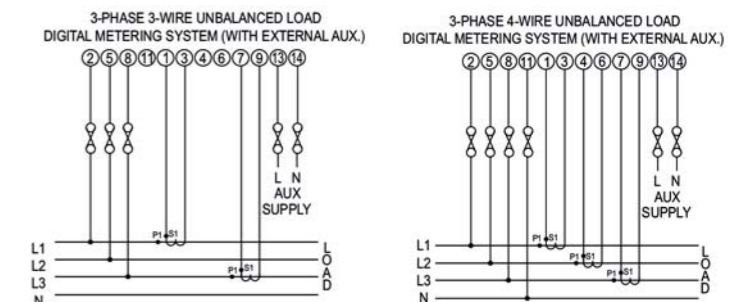

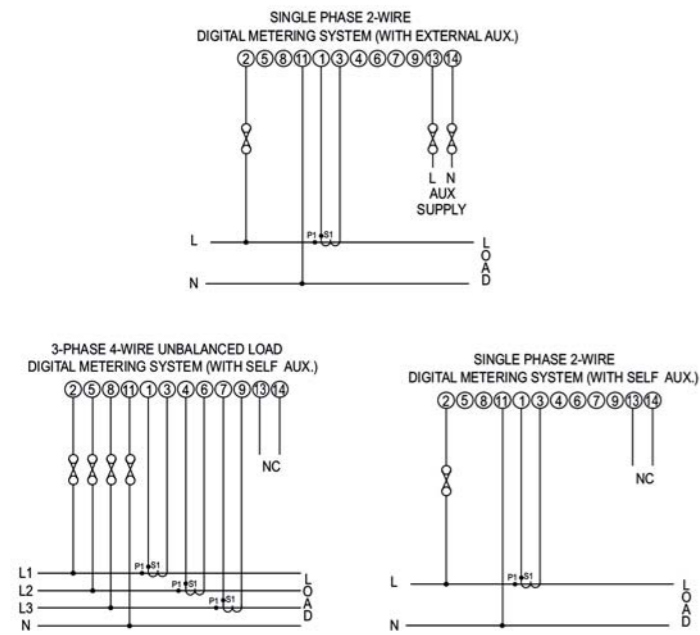

9. Specification

System	
3 Phase 3 Wire / 4 Wire or Single Phase programmable at site	
Inputs	
Nominal Input Voltage	290V LN, (500 VL-L)
(Three wire and Four wire)	
System Primary Values	100VL-L to 692 kVL-L, programmable at site
System Secondary Values	100VL-L to 500 VL-L, programmable at site
Max continuous input voltage	120% of Rated Value
Max short duration input voltage	2 x Rated Value (1s application repeated 10 times at 10s intervals)
Nominal input voltage burden	0.3VA approx. per phase
Nominal Input Current	
Max continuous input current	5A AC
Nominal input current burden	120% of Rated Value
Max short duration current input	< 0.2VA Approx. Per phase 20 x Rated Value (1s application repeated 5 times at 5 min. intervals)
System CT primary values	Std. Values 1 to 9999A (1 or 5 Amp secondary)
System Secondary Values	1A / 5A, programmable at site
Operating Measuring Ranges	
Voltage	10 ... 120 % of Rated Value
Voltage with Self Aux	25 ... 120% of Rated Value
Current	10 ... 120 % of Rated Value
Frequency	45 .. 65 Hz
Auxiliary	
External Auxiliary Supply	40V to 300V AC/DC (+/- 5%)
Self Powered	Input Voltage Range 70 V to 250V L-N (Self Powered meter is available only in 3 Phase 4W and Single phase network)
Frequency Range	45 to 65 Hz
VA Burden	3 VA Approx.
Accuracy	
External Auxiliary Supply	40V to 300V AC/DC (+/- 5%)
Self Powered	Input Voltage Range 70 V to 250V L-N (Self Powered meter is available only in 3 Phase 4W and Single phase network)
Frequency Range	45 to 65 Hz
VA Burden	3 VA Approx.
Reference conditions for Accuracy :	
Reference temperature	23°C + 2°C
Input frequency	50 or 60Hz + 2%
Input waveform	Sinusoidal (distortion factor 0.005)
Auxiliary supply voltage	Rated Value + 1 %
Auxiliary supply frequency	Rated Value + 1 %
Nominal range of use of influence quantities for measurands	
Voltage	10 .. 120 % of Rated Value
Current	10 .. 120 % of Rated Value
Input frequency	Rated Value + 10 %
Temperature	0 to 50°C
Auxiliary supply voltage	Rated Value + 5 %
Auxiliary supply frequency	Rated Value + 10 %
Temperature Coefficient	0.05% / 0C for Current (10...120% of Rated Value)
(For Rated value range of use 0... 50°C)	0.025% / 0C for Voltage (10...120% of Rated Value)

Error change due to variation of an influence quantity 2 * Error allowed for the reference condition applied in the test.

Display
LED 1 line 4 digits . Digit height 20mm
Alphanumeric Display For Displaying Units and Parameter
Display height : 14mm
Bar Graph For Displaying % Load on System
Update rate Approx. 1 seconds

Controls
User Interface 4 Keys

Standards
EMC Compatibility IEC 61326-1:2005
10V/m min-Level 3 industrial low level
Electromagnetic radiation environment
IEC 61000-4-3.
Safety IEC 61010-1
IP for water & dust IEC 60529

Isolation
Dielectric voltage withstand test between circuits and accessible surfaces 3.3 kV RMS 50 Hz for 1 minute between all electrical circuits

Environmental conditions
Operating temperature 0 to 50°C
Storage temperature -25 to +70°C
Relative humidity 0 .. 90 % RH (Non condensing)
Warm up time 3 minute (minimum)
Shock 15g in 3 planes
Vibration 10 .. 55 Hz, 0.15mm amplitude

Enclosure front IP 50
Enclosure back IP 20

Enclosure
Style 96mm x 96mm DIN Quadratic
Material Polycarbonate Housing
Terminals Screw-type terminals
Depth < 60 mm
Weight 300 gram Approx.

Ordering Code
Article No : 136-5379
RS Pro 1 Line display Volts, Amp Frequency and Hours Run, 96x96mm 3 Phase 3/4W programmable onsite,
AC VAF, 20mm display with alphanumeric display,
Input. 100-500VLL,
Input. 1 or 5 Amps AC,
Supply voltage. 40-300V AC/DC auxiliary (Programmable CT/PT primary and secondary values with Limit Switch/Relay O/P)

The Information contained in these installation instructions is for use only by installers trained to make electrical power installations and is intended to describe the correct method of installation for this product. However, Company has no control over the field conditions which influence product installation.
It is the user's responsibility to determine the suitability of the installation method in the user's field conditions. Company only obligations are those in Company standard Conditions of Sale for this product and in no case will Company be liable for any other incidental, indirect or consequential damages arising from the use or misuse of the products.

FOR MORE INFORMATION VISIT THIS SITE
<http://www.rs-components.com/index.html>