

Datasheet

LED Indicator Lamp

RS ITEM NO 209-664

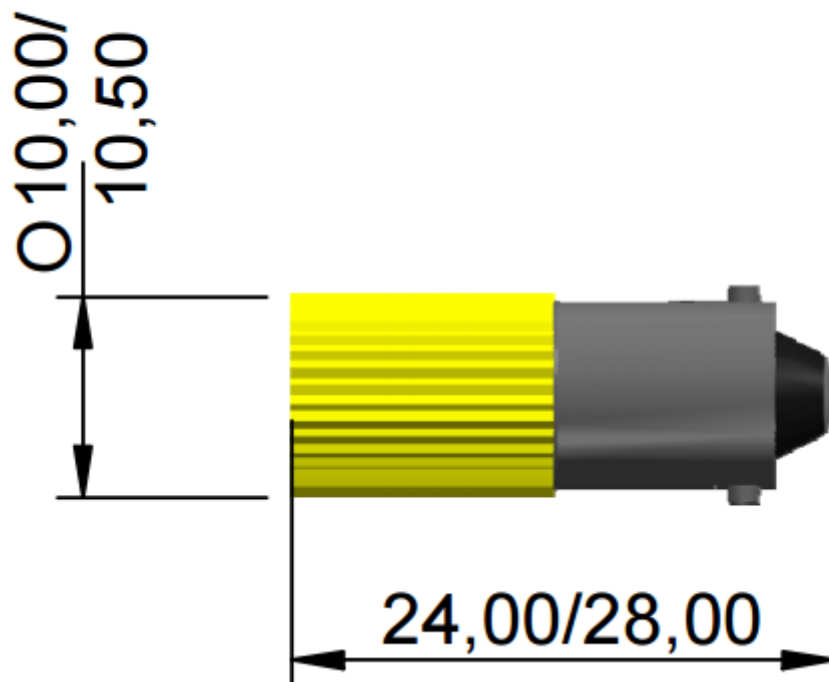

LED/Multiled	LED	Optimum voltage (V)	28Vdc	Intensity	55mcd
Mounting Size	10x24	Rectifier	-		
Mounting Finish		AC current	-		
Protection	-	DC current	9mA		
Mount Holder	Ba9	Voltage Tolerance (%)	10%		
Chip Qty	4	Optimum temperature (°C)	-30°C...+60°C		
Indicator colour	Yellow	Storage temperature (°C)	-30°C...+60°C		
Wavelength (nm)	585	Contact Tab	Ba9 Base Cap		



Dimension in mm (typical), not to scale.
We reserve the right to make changes without further notice to this product to improve reliability, function or design.