



Brand of NTN Group

## Technical data

### UC208G2L3

Insert bearings



Spherical outer diameter, fixing by socket set screw, triple lip seal

#### VISUAL (S)

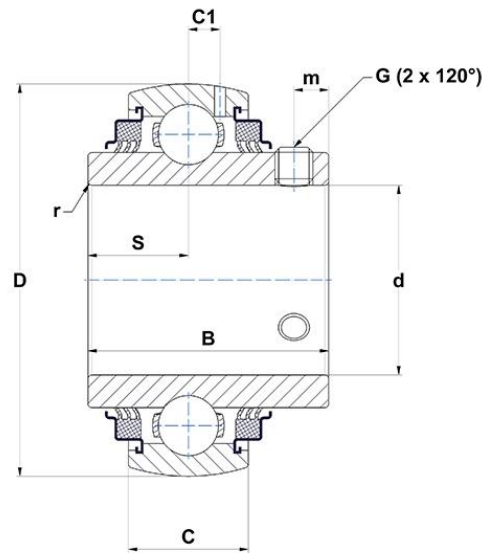

#### PRODUCT DEFINITION

<b>Brand</b>	SNR
<b>B - Width of Inner Ring</b>	49,2 mm
<b>C - Width of Outer Ring</b>	21 mm
<b>C1 - Distance center of OR to center of lubrication zone</b>	6,3 mm
<b>d - Shaft diameter</b>	40 mm
<b>D - Outer diameter of OR</b>	80 mm
<b>G - Set screw size</b>	M8x1
<b>m - Distance to set screw</b>	8 mm



**NTN Europe**

1 rue des Usines · BP 2017 · 74010 Annecy Cedex · France · Tel. +33 (0)4 50 65 30 00  
S.A. au capital de 322 639 919 € · RCS ANNECY B 325 821 072 · Id. Fiscale : FR 48 325 821 072  
SIRET 325 821 072 00015 · Code APE 2815 Z · Code NACE 28.15

### PRODUCT DEFINITION

<b>r - Radius Inner Ring</b>	1.1
<b>S - Distance front side/bearing centre</b>	19 mm
<b>f0 - Factor</b>	14
<b>SW - Wrench size</b>	4 mm

### PRODUCT PERFORMANCE

<b>C - Dynamic load rating</b>	29600000 mN
<b>C0 - Static load rating</b>	18200000 mN
<b>Operating temperature min.</b>	253,15 °K
<b>Operating temperature max.</b>	373,15 °K

### OTHER FEATURES

<b>Mass</b>	0,64 kg
<b>Recommended tightening torque for set screw</b>	11.5 N-m

### BEARING FREQUENCIES

<b>BPFO - Over rolling frequency on outer ring (60 rpm)</b>	3.607035 Hz
<b>BPMF - Over rolling frequency on inner (60 rpm)</b>	5.392965 Hz
<b>BSF - Over rolling frequency on rolling element (60 rpm)</b>	4.84095457487135 Hz
<b>BRF - Rotational frequency - rolling element (60 rpm)</b>	2.42047728743567 Hz
<b>FTF - Rotational frequency - cage (60 rpm)</b>	0.400781666666667 Hz

