

SQUARE NUT 30 M 06 WITH POSITION-FIXING, ESD CONDUCTIVE

Article Nr. 21.2342/2

[See the product on the website](#) →

[Download CAD Files](#) →

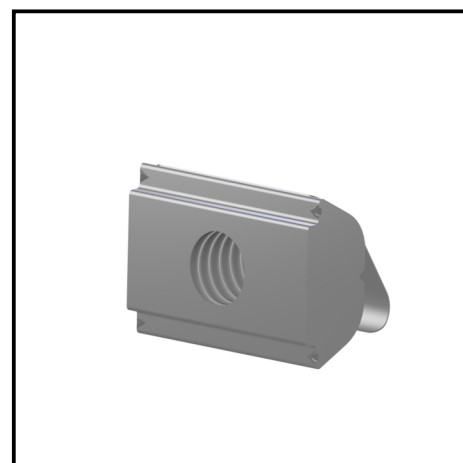
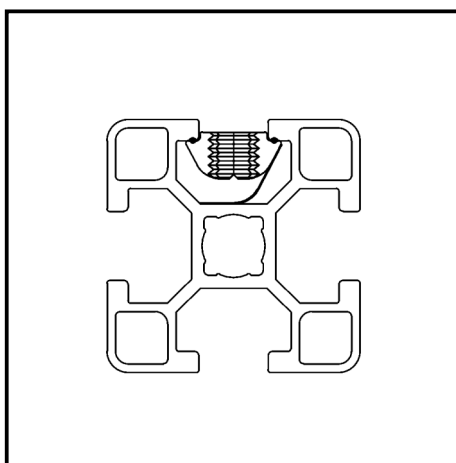
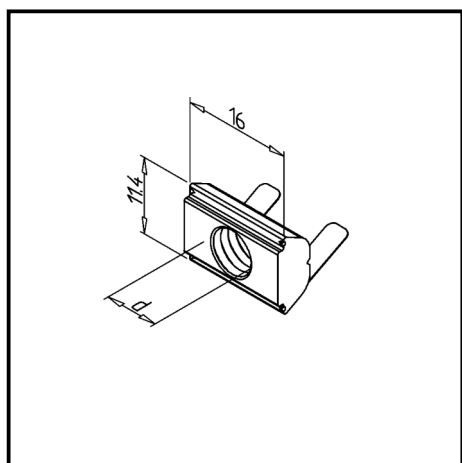

TECHN. DATA / ITEMS SUPPLIED

- Steel, galvanized
- Thread (d) : M 6
- Conductive, also suitable for ESD applications
- Weight = 0.005 kg/piece

APPLICATIONS

- The spring plate holds the nut in the desired position
- Sliding nuts can be swiveled into the profile (series 45) at any point

ASSEMBLY

- Mounting by swiveling into the groove