



PC Cooling fans

High performance case fans

- DC fans
- Fibreglass-reinforced plastic casing. Impeller PA, housing PBT
- Protected against reverse polarity and locking
- Sensor signal for speed monitoring
- Fitted with 3 pin connector
- Connection via lead 313mm (+/- 10mm)
- Blowing over struts
- Protection IP20

Part Number	Airflow	Airflow	Voltage	Voltage Range	Noise	Sound Power	Bearings	Power	Speed	Temp range	Length	Width	Depth	Connector
	m ³ /h	CFM	VDC	VDC	dB(A)	Bel		W	RPM	°C	mm	mm	mm	
412J/2HH-RS0	24	14.1	12	8...13.5	46	6.1	Ball	3.30	13000	-20...+60	40	40	25	Molex 22-01-2035
622/2N-RS0	40	23.5	12	8...15	35	4.7	Ball	1.90	6100	-20...+70	60	60	25	Molex 22-01-2035
612J/2H-RS0	70	41.1	12	7...13.6	53	6.4	Ball	7.70	11700	-20...+70	60	60	32	Molex 22-01-2035
8212J/2N-RS0	132	77.7	12	7...13.6	55	6.6	Ball	10.00	8400	-20...+70	80	80	38	Molex 22-01-2035
8212J/2H3-RS0	190	111.8	12	6...13.8	66	7.3	Ball	25.00	12000	-20...+70	80	80	38	Molex 22-01-2035
3412N/2-RS0	84	49.4	12	8...15	32	4.7	Ball	2.20	2700	-20...+70	92	92	25	Molex 22-01-2035
3412N/2HH-RS0	102	60	12	8...13.2	39	5.1	Ball	2.90	3250	-20...+60	92	92	25	Molex 22-01-2035
3212J/2H-RS0	146	86	12	7...15	55	6.4	Ball	9.00	6800	-20...+70	92	92	38	Molex 22-01-2035
4412F/2-RS0	170	100.1	12	8...12.6	43	5.3	Ball	5.30	2900	-20...+60	119	119	25	Molex 22-01-2035
4412FN/2H-RS0	225	132.4	12	7...13.2	55	6.7	Ball	12.00	5400	-20...+70	119	119	25	Molex 22-01-2035
4112N/2H4-RS0*	355	208.9	12	9...14	67	7.4	Ball	32.00	6800	-20...+65	119	119	38	Molex 22-01-2035

* Air intake over struts and aluminium housing.

Fixing Centres

Frame Size	Dimension A (mm)
40	32
60	50
80	71.5
92	82.5
119	104.8

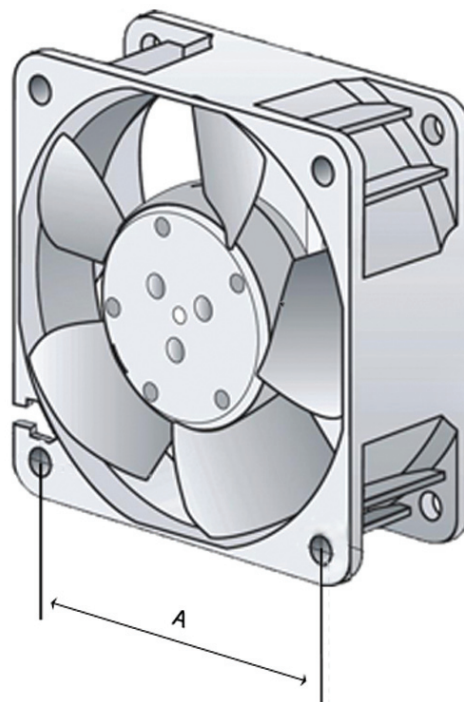

Terminal Assignment

- 1 = Blue (-)
- 2 = Red (+)
- 3 = White (Tacho)



Speed signal /2

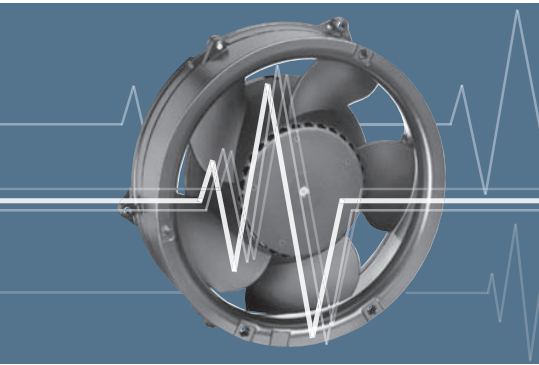

- Speed-proportional rectangular pulse for external speed monitoring of fan motor.
- 2, 3 or 6 pulses per revolution.
- Open collector signal output.
- Extremely wide operating voltage range.
- Easy adaptation to user interface.
- Connection via separate lead.
- The sensor signal also serves as a major comparison variable for setting and maintaining the setpoint speed for interactive or controlled cooling with one or several interconnected fans.

Electrical connection

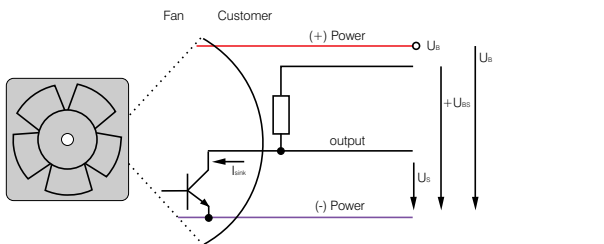

All voltages measured to ground.
External load resistor R_a / U_S / U_{BS} required.

$$R_a = \frac{U_{BS} - U_{SLOW}}{I_{SINK}}$$

Signal output voltage

Standard signal for all models (exceptions see below)

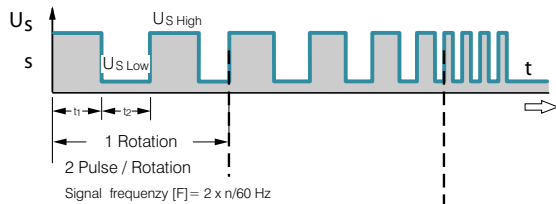

only for 4100 NH7 and NH8

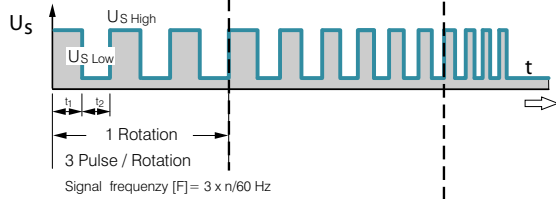

All TD fans. Ex.: 6400 TD

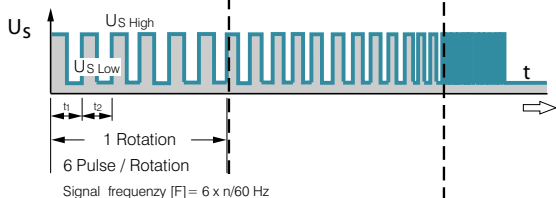

Fan Speed

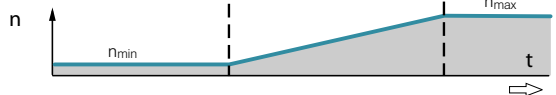

Signal data

Type	Speed signal $U_{S \text{ Low}}$ VDC	Condition: sink mA	Speed signal $U_{S \text{ High}}$ VDC	Condition: source mA	Sensor operating voltage U_{BS} VDC	Perm. sink current $I_{sink \text{ max}}$ mA	Pulses per revolution	Fan description
250	≤ 0,4	≤ 2	30	0	≤ 30	2	2	23
400 F	≤ 0,4	1	30	0	≤ 30	≤ 2	2	24
400	≤ 0,4	1	30	0	≤ 30	≤ 2	2	25
400 J	≤ 0,4	2	30	0	≤ 30	≤ 4	2	26
500 F	≤ 0,4	1	30	0	≤ 30	≤ 2	2	27
600 F	≤ 0,4	1	30	0	≤ 30	≤ 2	2	28
620	≤ 0,4	2	30	0	≤ 30	≤ 4	2	29
630 U	≤ 0,4	2	30	0	≤ 30	≤ 4	2	30
600 N	≤ 0,4	2	28	0	≤ 28	≤ 4	2	31
600 J	≤ 0,4	2	30	0	≤ 30	≤ 4	2	33
700 F	≤ 0,4	2	30	0	≤ 30	≤ 4	2	34
8450	≤ 0,4	2	28	0	≤ 28	≤ 4	2	35
8400 N	≤ 0,4	2	28	0	≤ 28	≤ 4	2	36
8400 N VARIOFAN	≤ 0,4	2	30	0	≤ 30	≤ 4	2	37
8300	≤ 0,4	2	30	0	≤ 30	≤ 4	2	38
8200 J	≤ 0,4	2	30	0	≤ 30	≤ 4	2	39
3400 N	≤ 0,4	2	28	0	≤ 28	≤ 4	2	40
3400 N VARIOFAN	≤ 0,4	2	30	0	≤ 30	≤ 4	2	41
3300	≤ 0,4	2	30	0	≤ 30	≤ 4	2	42
3212 J / 3214 J	≤ 0,4	2	30	0	≤ 30	≤ 4	2	43
3218 J	≤ 0,4	2	60	0	≤ 60	≤ 4	2	43
4412 F / 4414 F	≤ 0,4	2	30	0	≤ 30	≤ 4	2	44
4418 F	≤ 0,4	2	60	0	≤ 60	≤ 4	2	44
4400 FN	≤ 0,4	2	30	0	≤ 30	≤ 4	2	45
4312 / 4314	≤ 0,4	2	30	0	≤ 30	≤ 4	2	46
4318	≤ 0,4	2	60	0	≤ 60	≤ 4	2	46
4312 / 4314 VARIOFAN	≤ 0,4	2	30	0	≤ 30	≤ 4	2	47
4318 VARIOFAN	≤ 0,4	2	60	0	≤ 60	≤ 4	2	47
4400	≤ 0,4	2	30	0	≤ 30	≤ 4	2	48
4100 N	≤ 0,4	2	30	0	≤ 30	≤ 4	2	49
4100 NHH...NH6	≤ 0,4	2	≤ 60	0	≤ 60	≤ 10	2	50
4100 NH7...NH8	≤ 0,4	2	≤ 60	0	≤ 60	≤ 20	3	51
DV 4100	≤ 0,4	2	30	0	≤ 30	≤ 4	2	52
5200 N	≤ 0,4	2	30	0	≤ 30	≤ 4	2	53



Available on request:

- Electrically isolated sensor and signal circuit.
- Varying voltage potentials for power and logic circuit.

Signal data	Speed signal U_S Low	Condition: I_{sink}	Speed signal U_S High	Condition: I_{source}	Sensor operating voltage U_{BS}	Perm. sink current $I_{sink max.}$	Pulses per revolution	Fan description
Type	VDC	mA	VDC	mA	VDC	mA		Page
DV 5200	≤ 0,4	2	30	0	≤ 30	≤ 4	2	54
5112 N	≤ 0,4	2	15	0	≤ 5	≤ 20	2	55
5114 N / 5118 N	≤ 0,4	2	60	0	≤ 60	≤ 20	2	55
5300	≤ 0,4	2	≤ 72	0	≤ 72	≤ 4	2	56
5300 TD	≤ 0,4	2	72	0	≤ 72	≤ 20	6	57
7112 N / 7118 N	≤ 0,4	2	60	0	≤ 60	≤ 20	2	58
7114 N	≤ 0,4	2	30	0	≤ 30	≤ 20	2	58
7200 N	≤ 0,4	2	15	0	≤ 15	≤ 20	2	59
6300	≤ 0,4	2	≤ 72	0	≤ 72	≤ 20	2	61
6300 TD	≤ 0,4	2	72	0	≤ 72	≤ 20	6	62
DV 6200	≤ 0,4	2	30	0	≤ 60	≤ 20	2	64
6400	≤ 0,4	2	60	0	≤ 60	≤ 20	2	66
2200 FTD	≤ 0,4	2	72	0	≤ 72	≤ 20	6	70
RL 48	≤ 0,4	2	3	0	≤ 30	≤ 4	2	81
RL 65	≤ 0,4	2	30	0	≤ 30	≤ 4	2	82
RL 90 N	≤ 0,4	2	30	0	≤ 30	≤ 4	2	83
RLF 100	≤ 0,4	2	30	0	≤ 30	≤ 4	2	84
RG 90 N	≤ 0,4	2	30	0	≤ 30	≤ 4	2	85
RG 125 N	≤ 0,4	2	30	0	≤ 30	≤ 4	2	86
RG 160 N	≤ 0,4	2	30	0	≤ 30	≤ 20	2	87
RG 160 TD	≤ 0,4	2	60	0	≤ 60	≤ 20	6	88
RG 190 TD	≤ 0,4	2	72	0	≤ 72	≤ 20	6	89
RG 220 TD	≤ 0,4	2	72	0	≤ 72	≤ 20	6	90
RG 225 TD	≤ 0,4	2	72	0	≤ 72	≤ 20	6	91
RET 97 TD	≤ 0,4	2	72	0	≤ 72	≤ 20	6	92
REF 100	≤ 0,4	2	30	0	≤ 30	≤ 4	2	93
RER 120 TD	≤ 0,4	2	72	0	≤ 72	≤ 20	6	95
RER 133 TD	≤ 0,4	2	72	0	≤ 72	≤ 20	6	97
RER 160 TD	≤ 0,4	2	60	0	≤ 60	≤ 20	6	99
REF 175 TD	≤ 0,4	2	72	0	≤ 72	≤ 20	6	100
RER 175 TD	≤ 0,4	2	72	0	≤ 72	≤ 20	6	101
RER 190 TD	≤ 0,4	2	72	0	≤ 72	≤ 20	6	102
RER 220 TD	≤ 0,4	2	72	0	≤ 72	≤ 20	6	103
RER 225 TD	≤ 0,4	2	72	0	≤ 72	≤ 20	6	104

Attention:

With these fan options, deviations in regard to temperature range, voltage range and power consumption are possible compared with standard fan data.

