

Detection from both left and right directions contributes to improved and flexible design of the set mechanism

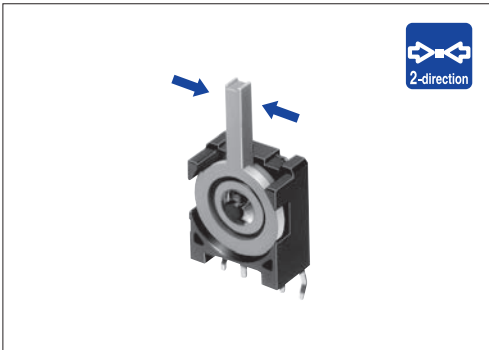

Typical Specifications

Items		Specifications
Rating (max.)/(min.) (Resistive load)		0.1A 12V DC / 50μA 3V DC
Contact resistance (Initial / After operating life)		100mΩ max. / 300mΩ max.
Operating force		0.7N max.
Operating life	Without load	50,000cycles
	With load	50,000cycles (0.1A 12V DC)

Product Line

Poles	Positions	Changeover timing	Terminal type	Mounting method	Minimum order unit (pcs)		Product No.	Drawing No.
					Japan	Export		
1	2	Non shorting	For PC board	PC board	600	3,000	SSCF110100	1
				Screw			SSCF210100	2
			For Lead	SSCF210300			3	
			For PC board	PC board with hook			SSCF310100	4

Packing Specifications

Bulk

Number of packages (pcs.)		Export package measurements (mm)
1 case /Japan	1 case /export packing	
600	3,000	400×270×290

Dimensions

Unit:mm

No.	Photo	Style	PC board mounting hole dimensions
1			

SSCF Two-way Detection Type

Detector

Slide

Push

Rotary

Power

Dual-In-line
Package Type

General-
purpose Type

Water-proof
Type

■ Dimensions

Unit:mm

No.	Photo	Style
2		
3		
4		
		<p>PC board mounting hole dimensions</p>







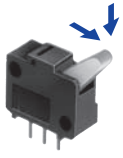
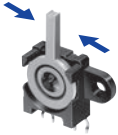
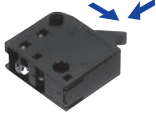

■ Terminal Type

Unit:mm

For PC board	For Lead
<p>Thickness of board in use : t1.2 , t1.6</p>	

■ Circuit Diagram

For PC board	For Lead

Series		General-purpose Type				
		SSCT	SSCF	SSCW	SPVQ5	SSCL
Photo						
Operation type		Two-way			One-way	Two-way
Dimensions (mm)	W	12.5	11	13.1	13.8	11
	D	5	5.8	11.35		16.1
	H	11.5	12.4	5.3	5.8	5.3
Operating temperature range		-40°C to +85°C				
Automotive use		●	●	●	●	●
Life cycle (availability)						
Poles / Positions		1/2		1/1	1/2	
Rating (max.) (Resistive load)		0.1A 12V DC				
Rating (min.) (Resistive load)		50μA 3V DC		100μA 3V DC	50μA 5V DC	
Durability	Operating life without load	10,000cycles 500mΩ max.	50,000cycles 300mΩ max.	100,000cycles 1Ω max.	300,000cycles 1Ω max.	50,000cycles 1Ω max.
	Operating life with load Rating (max.) (Resistive load)	10,000cycles 500mΩ max.	50,000cycles 300mΩ max.	100,000cycles 1Ω max.	300,000cycles 1Ω max.	50,000cycles 1Ω max.
Electrical performance	Initial contact resistance	200mΩ max.	100mΩ max.	500mΩ max.		
	Insulation resistance	100MΩ min. 250V DC	100MΩ min. 100V DC	100MΩ min. 250V DC	100MΩ min. 500V DC	100MΩ min. 100V DC
	Voltage proof	250V AC for 1minute	100V AC for 1 minute	250V AC for 1minute	500V AC for 1minute	100V AC for 1minute
Mechanical performance	Terminal strength	3N for 1minute	5N for 1minute	—		
	Actuator strength	20N	10N	20N		10N
Environmental performance	Cold	-40°C 500h				
	Dry heat	85°C 500h				
	Damp heat	60°C, 90 to 95%RH 500h				
Operation force		0.7±0.3N	0.7N max.	1N max.	2N max.	0.7N max.
Page		40	41	43	44	45

Detector Switches Soldering Conditions 71
 Detector Switches Cautions 72

Note
 ● Indicates applicability to all products in the series.

Detector Switches Soldering Conditions

Example of Reflow Soldering Condition

1. Heating method: Double heating method with infrared heater.
2. Temperature measurement: Thermocouple $\phi 0.1$ to 0.2 CA (K) or CC (T) at soldering portion (copper foil surface).
A heat resisting tape should be used for fixed measurement.
3. Temperature profile

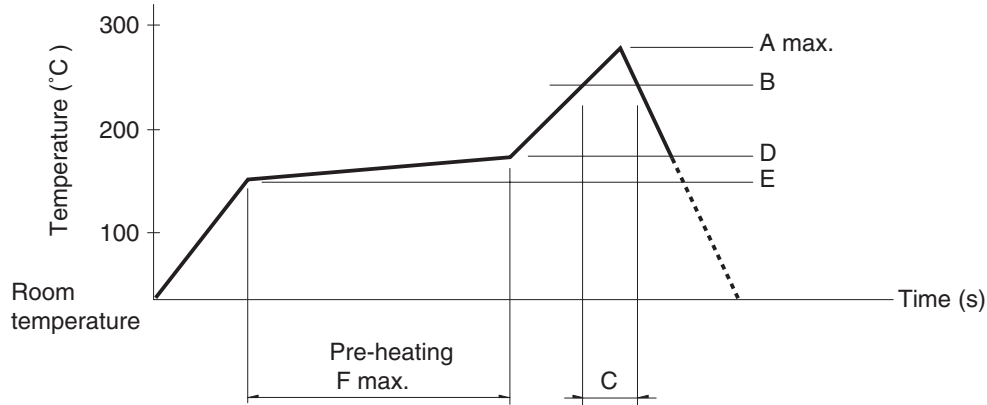

Series (Reflow type)	A (°C) 3s max.	B (°C)	C (s)	D (°C)	E (°C)	F (s)
SPPB	250		40			
SPPW8			35			
SPVE	260	230	40	180	150	120
SPVL						
SPVM						
SPVN						
SPVR						
SPVS						
SPVT						
SSCM						
SSCQ						
SPVQC	250					

Notes

1. The condition mentioned above is the temperature on the mounting surface of a PC board. There are cases where the PC board's temperature greatly differs from that of the switch, surface depending on the PC board's material, size, thickness, etc.
The above-stated conditions shall also apply to switch surface temperatures.
2. Soldering conditions differ depending on reflow soldering machines.
Prior verification of soldering condition is highly recommended.

Reference for Hand Soldering

Series	Soldering temperature	Soldering time
SPVS, SPVN, SPVT, SPVM, SPVR, SPVE, SPPW8, SSCQ, SSCM, SPVL, SSCT, SPVQC	350±5°C	3s max.
SPVQ1, SPVQ3, SPVQ6, SPVQ7, SPVQ8, SPVQ9, SSCN, SPVQA	300±10°C	3 +1 / 0s
SPPB (Reflow)	300±5°C	5s max.
SSCF, SPPB (For Lead, Dip)	350±10°C	3 +1 / 0s

Reference for Dip Soldering

(For PC board terminal types)

Series	Items		Dip soldering	
	Preheating temperature	Preheating time	Soldering temperature	Duration of immersion
SSCT, SPVQ1, SPVQ3, SPVQ6, SPVQ7, SPVQ8, SPVQ9, SPVQA	100±10°C	60s max.	260±5°C	5±1s
SPPW8, SPPB	100 °C max.	60s max.	255±5°C	5±1s
SSCF	—		260±5°C	5±1s