

Connector PowerTOP® - Part no. 3953

- screw terminals
- with highly heat resistant contact carrier
- cable gland and external cable grip

Protection type	IP 44
Ampere	16 A
Poles	3p
Voltage	110
Hertz	50-60Hz
Earth position	4h
Contact	highly heat resistant contact carrier
Connection technology	Screw terminals

Std. Pack. 10 Qty.

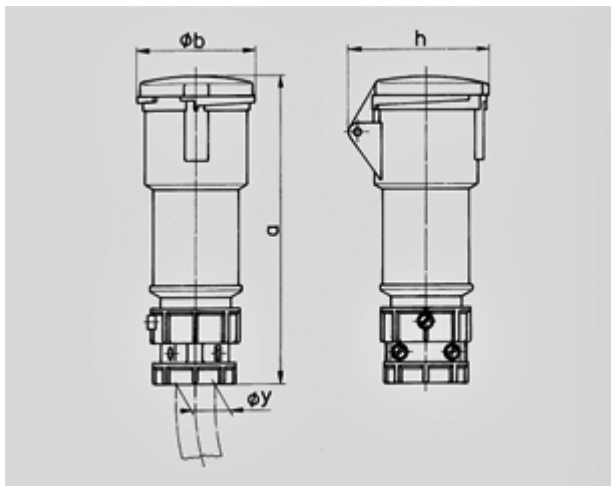

Drawing 3 MB 51/3	Amp. Poles	16			32		
		3	4	5	3	4	5
Dim. in mm	a	165	180	190	214	214	223
	b	60	68	76	82	82	89
	h	76	84	90	92	92	99
	y	19	19	22	24,5	24,5	28,5
Terminal for cond. cross		1	1	1	2,5	2,5	2,5
section (mm ²) min.-max.		-2,5	-2,5	-2,5	-6	-6	-6