

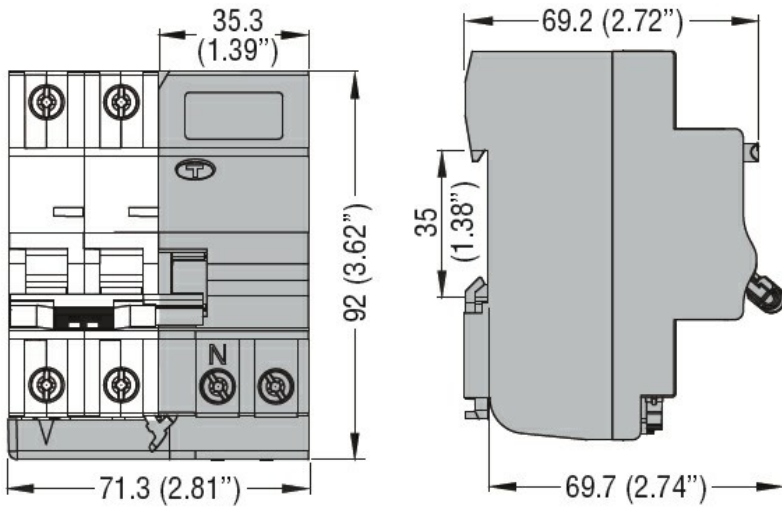

Product designation	Residual block add-on		
Product type designation	P1 RA		
Number of poles	2P		
Number of DIN modules	2		
Compliance	IEC		
Electrical features			
Rated insulation voltage Ui	V	400	
Rated impulse withstand voltage Uimp	kV	4	
Rated operational voltage AC (IEC)	VAC	230/400	
Rated frequency	Hz	50/60	
Rated current (In)	A	40	
Residual operation characteristic	A		
Ambient conditions			
Operating temperature	min	°C	-35
	max	°C	70
Storage temperature	min	°C	-40
	max	°C	80
Max altitude	m	2000	
Mechanical features			
Operating position	normal	35mm DIN rail	
Mounting	35mm DIN rail		
Tightening torque for terminals	max	Nm	2
	max	lbft	1.5
Terminals tool	Pz 2		
Conductor section	min (IEC)	mm ²	1
	max (IEC)	mm ²	16
	min (AWG)	14	
	max (AWG)	6	
Weight	g	160	
Frontal IP degree	IP20		
Pollution degree	2		
Dimensions			



Certifications and compliance

Compliance

IEC/EN 61009-1

Certifications

EAC

TÜV-SUD