

Rittal – The System.

Faster – better – everywhere.

AX. KX.

System perfection

Compact and small enclosures.



ENCLOSURES

POWER DISTRIBUTION

CLIMATE CONTROL

IT INFRASTRUCTURE

SOFTWARE & SERVICES



FRIEDHELM LOH GROUP

Rittal – The System.

Faster – better – everywhere.



ENCLOSURES

POWER DISTRIBUTION

CLIMATE CONTROL

FRIEDHELM LOH GROUP

End-to-end system solutions
for enhanced efficiency.

SYSTEM 4.0

The new Platform for Industry 4.0

Following on from the Blue e+ cooling units and the baying enclosure system VX25, the compact enclosures AX and the small enclosures KX are the final links in the chain. As a result of this product launch, the entire Rittal core portfolio is ideally equipped for the new requirements resulting from digitalisation and plays a key role in optimising customers' value chains.

A system solution for even easier assembly

Simplifying procedures saves time and money. The new generation achieves this by significantly improving details that permanently optimise assembly – from tool-free assembly to removing the need to machine enclosures and maintaining UL approvals, even after replacing standard components with Rittal accessories. All this really helps make control and switchgear engineering processes simpler, faster, more flexible and more reliable.

IT INFRASTRUCTURE

SOFTWARE & SERVICES



COMPACT AND SMALL ENCLOSURES

The baying enclosure system VX25 was the first step into a completely new era of enclosure technology, an era characterised by a whole host of features for far easier installation and perfect integration into state-of-the-art manufacturing processes in line with Industry 4.0 principles. The new compact enclosures AX and small enclosures KX continue on seamlessly from this. The interior installation is largely compatible, which creates completely new engineering and installation synergies.



ENCLOSURES

POWER DISTRIBUTION

CLIMATE CONTROL

FRIEDHELM LOH GROUP

Compact enclosures AX



Top customer benefits page 18
 Basic enclosure AX, sheet steel from page 32
 Accessories AX from page 60



Wall-mounted enclosures AX
 with 482.6 mm (19") mounting angles, depth-variable from page 40
 Accessories AX from page 60



Operating housings AX with handle strips from page 44
 Operating housings AX for desktop TFT up to 24" from page 46
 Accessories AX from page 60

Small enclosures KX



Top customer benefits page 19
 Terminal boxes KX, sheet steel, without gland plate from page 100
 Terminal boxes KX, sheet steel, with gland plate from page 103
 Accessories KX from page 124



E-Box KX, sheet steel from page 110
 Accessories KX from page 124



Bus enclosures KX, sheet steel from page 118
 Accessories KX from page 124



1961



2019

ENCLOSURES

POWER DISTRIBUTION

CLIMATE CONTROL

AX. KX. **SYSTEM PERFECTION.**

A wealth of experience for
even greater efficiency.

THE ORIGINAL

Rittal invented the standard enclosure

In 1961, Rittal was the first company in the world to series-produce enclosures. It all started with the compact enclosure AE, the predecessor of the current AX series. Going against industry advice, Rudolf Loh demonstrated a great deal of courage and considerable ingenuity in realising his vision of industrial-scale enclosure manufacture.

New horizons – AE becomes AX

A modest range of enclosures developed into the world's largest modular system for enclosure manufacture. Since Rittal was founded, the company's impressive innovative strength has spawned numerous enclosure generations, with millions of units in use – always ahead of their time. The latest generation – the AX – is a response to the challenges of the Industry 4.0 era and is the new original.

IT INFRASTRUCTURE

SOFTWARE & SERVICES





ENCLOSURES

POWER DISTRIBUTION

CLIMATE CONTROL

AX. KX. **SYSTEM PERFECTION.**

**Digital networking for
optimised value creation.**

THE SYSTEM CONSULTANT

Unrivalled added value from a single source

From engineering and system technology to automation – Rittal offers integrated, end-to-end solutions throughout the value chain. Rittal and Eplan software tools support the entire engineering process all the way through to documentation with high-quality and fully comprehensive offerings. With its coordinated enclosure, power distribution and climate control technology, the modular system from Rittal provides quick and flexible solutions for any challenge anywhere in the world. Thanks to equipment and tools for fully automated or manual machining and assembly, the efficient workflow never stops.

Saving time and boosting efficiency

Rittal data helps save a great deal of time in day-to-day work. It simplifies and facilitates design planning by seamlessly providing validated CAD data for all Rittal components. The resulting engineering data optimises planning certainty. Even more efficient planning is possible with EPLAN Pro Panel, the leading software solution for project planning and 3D enclosure design. What's more, the EPLAN Data Portal provides detailed CAD data for configuring the AX and KX.

ePLAN[®]
pro panel

ePLAN[®]
data portal

IT INFRASTRUCTURE

SOFTWARE & SERVICES



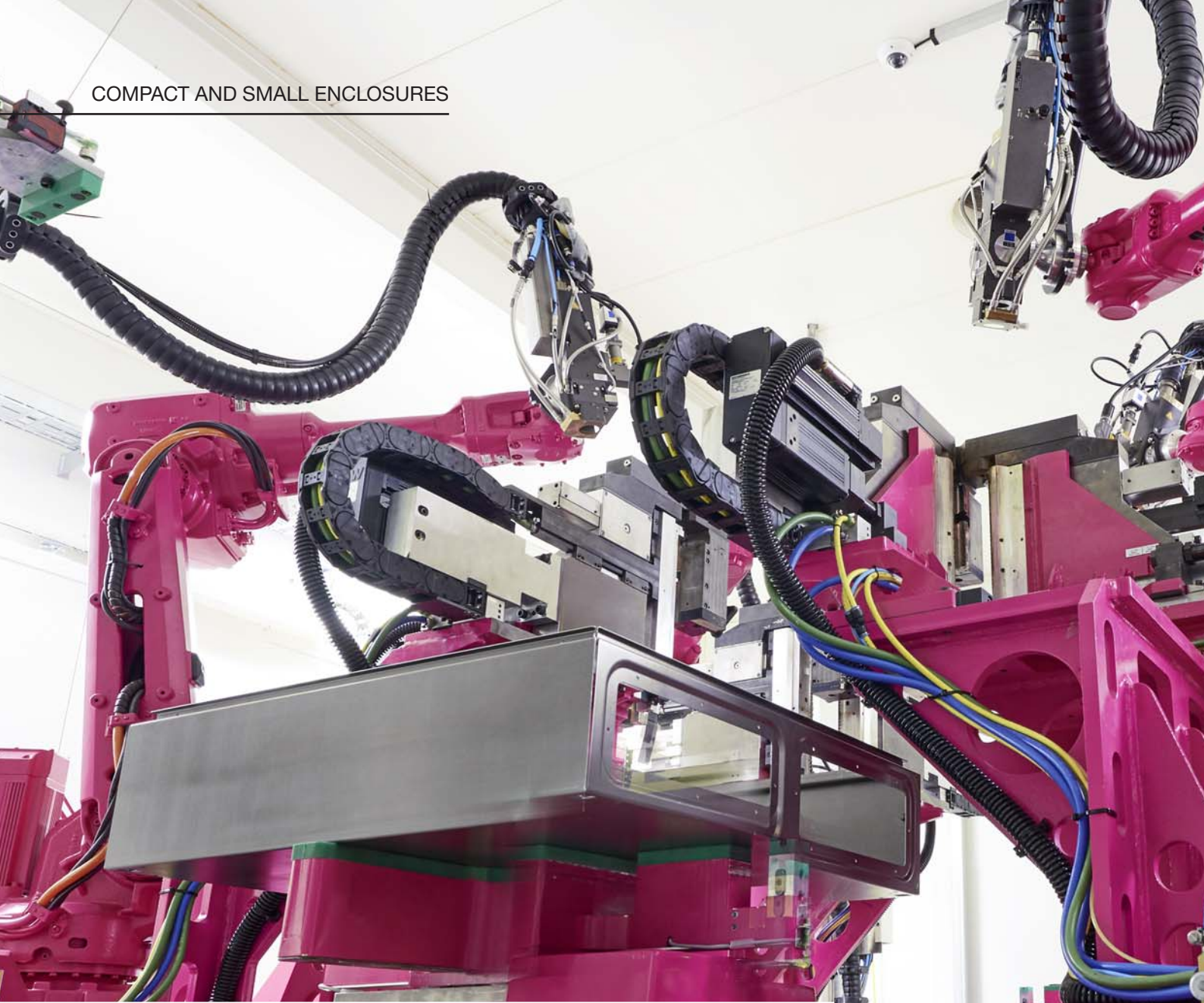

ENCLOSURES

POWER DISTRIBUTION

CLIMATE CONTROL

AX. KX. **SYSTEM PERFECTION.**

State-of-the-art production technology for a secure future.

THE TECHNOLOGY LEADER

Compact enclosures based on and geared towards Industry 4.0

A dedicated production plant has been built in Haiger for our new compact enclosures. A sum of 250 million euros has been invested in the world's most state-of-the-art production facility for compact and small enclosures based on Industry 4.0 criteria. The plant's highly automated production management will ensure the permanent availability of the standard portfolio.

AX is ideal for automated machining

This once again makes Rittal an industry pioneer. In addition to improving its own flexibility, the company also wanted to develop a high level of efficiency that could be carried right through to the customer's production process. Every enclosure leaving the newly built, highly automated Rittal plant in Haiger satisfies all the prerequisites for integration into downstream automated and mechanical processes.

Thanks to the packaging concept developed specially for the AX and KX, panels can simply be taken out without having to be dismantled and then fed directly into our customers' production process.

IT INFRASTRUCTURE

SOFTWARE & SERVICES



COMPACT AND SMALL ENCLOSURES

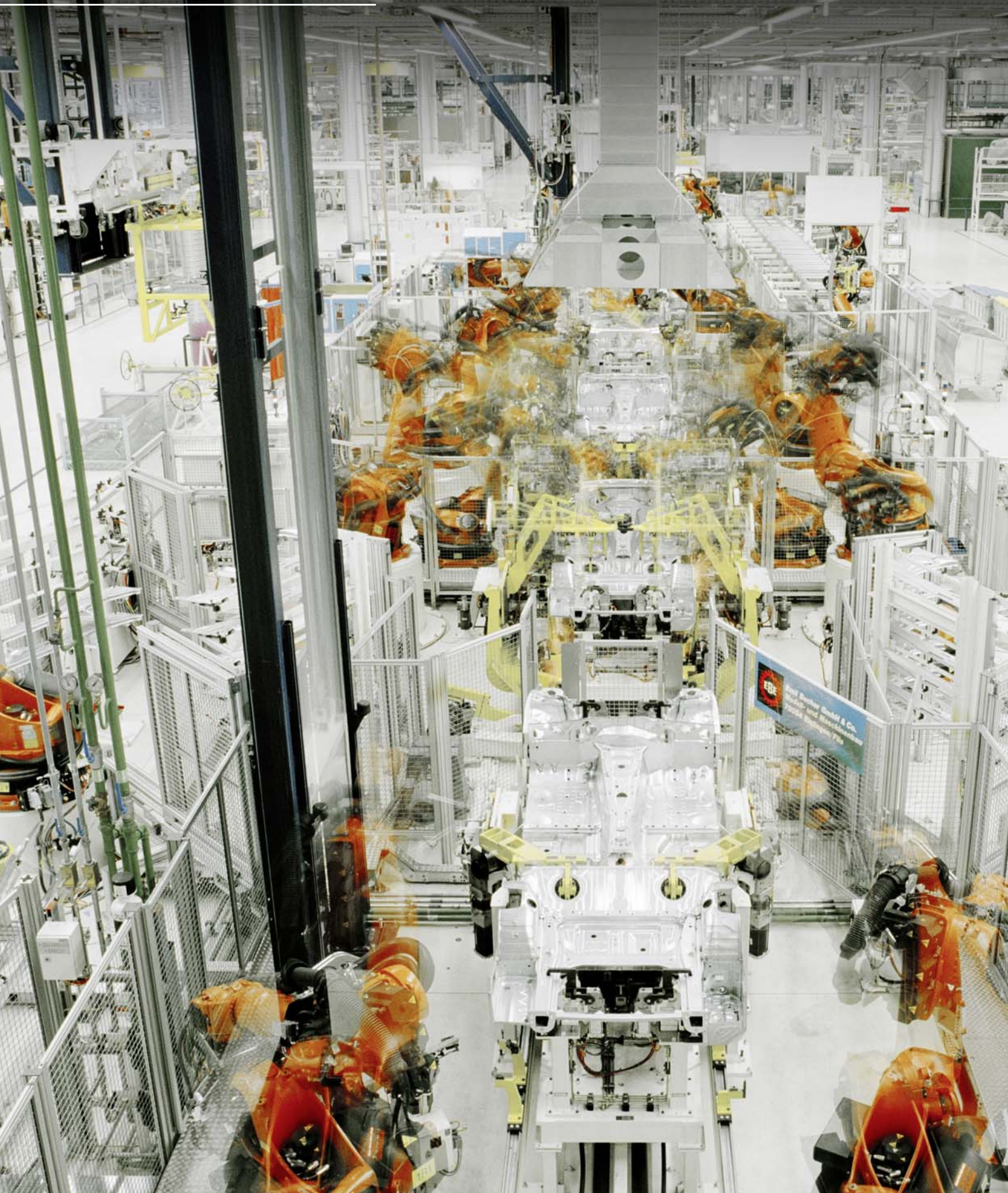

ENCLOSURES

POWER DISTRIBUTION

CLIMATE CONTROL

AX. KX. **SYSTEM PERFECTION.**

Specific solutions for any application.

THE INDUSTRY INSIDER

Solutions for every industry – around the globe

The AX and KX could not be more flexible and there's a good reason for this. Rittal knows all about the challenges digitalization is throwing up for the various markets. From plastics, chemicals, textiles and foodstuffs to automotive and mechanical engineering, Rittal meets the specific enclosure requirements of each and every sector of industry.

Internationally recognised approvals and certifications

Rittal enclosures are ideal for global use across a variety of industries. Internationally recognised approvals make it much easier to put the AX to quick and flexible use in any country the world over. The highest quality standards ensure reliability and a long service life, even under extreme conditions. Compliance with global standards and thus excellent future-proof credentials are ensured by stringent testing according to international regulations and regular production inspections by external test institutes.

IT INFRASTRUCTURE

SOFTWARE & SERVICES





ENCLOSURES

POWER DISTRIBUTION

CLIMATE CONTROL

AX. KX. **SYSTEM PERFECTION.**

Global logistics for rapid availability.

THE LOGISTICS PARTNER

Delivery off the shelf – within 24 hours

International customers expect short delivery times and flexibility when it comes to quantities. Rittal has the necessary logistics in place for a rapid response worldwide. The AX, the KX and the associated accessories are normally available anywhere in Europe within 24 hours. This makes customers' production operations far more flexible and also reduces the pressure on warehousing. Fully digitised workflows throughout the design and machining process create added value within the supply chain itself.

Global Rittal service network with 150 sites

AX and KX users can rely on the worldwide Rittal service network. A total of 1,000 trained Rittal service technicians are available at 150 service sites around the globe. In addition to maintenance and repair tasks, they also keep an eye out for potential savings. The global Rittal service centre can be contacted 24 hours a day, 365 days a year.

IT INFRASTRUCTURE

SOFTWARE & SERVICES





ENCLOSURES

POWER DISTRIBUTION

CLIMATE CONTROL

Multiple benefits for new opportunities.

THE VALUE ADDER

Simple

Fully digitised processes with top-quality 3D data and QR codes on panels to be machined allow for seamless monitoring and simplify the order process – from the receipt of goods through to completion. Streamlining the number of parts makes engineering easier while maintaining the same diversity of dimensions.

Flexible

Modular designs and optimised cut-outs/sizes help to better utilise the space inside the enclosure. Rails and integrated locators simplify interior installation. Work is also made easier by being able to machine panels supplied loose immediately and install doors without needing tools. Reducing the number of parts simplifies logistics and warehousing.

Fast

The new highly automated plant in Haiger ensures quick delivery and permanent availability (normally within 24 hours anywhere in Europe). All panels are supplied loose and assembly is a largely tool-free process. The new wall mounting bracket can be fixed in place from the outside in next to no time.

Safe

Protection classes and approvals improve reliability. Integrated locators throughout the housing ensure the interior installation rails can be precisely positioned and securely fastened – even under dynamic loads. The protection category is maintained after wall mounting brackets are attached.

Top customer benefits



Compact enclosures AX

Basic enclosure AX	Wall-mounted enclosures AX with 482.6 mm (19") mounting angles, depth-variable	Operating housings AX with handle strips	
All enclosure panels may be taken directly from the packaging, without dismantling, and machined		The aluminium front panel is easily removed and machined	
Interior installation on a 25 mm pitch pattern; no machining required	The 482.6 mm (19") mounting angles support depth-variable mounting on a 25 mm pitch pattern	Interior installation on a 25 mm pitch pattern; no machining required	
Wall mounting brackets are easily secured from the outside with a self-tapping screw while retaining the UL approval	Wall mounting brackets are easily secured from the outside with a self-tapping screw	The support arm may be fitted directly without machining	
A QR code on the enclosure, door and mounting plate allows seamless monitoring, from receipt of incoming goods through to delivery of the finished product	A QR code on the enclosure and door allows seamless monitoring, from receipt of incoming goods through to delivery of the finished product		
Simple earthing, even retrospectively, using machined keyholes in the mounting plate and perforated door strip	Simple earthing, even retrospectively, using machined keyholes in the perforated door strip	Simple earthing with a continuous M8 earthing connection	
The door and cam lock are quickly fitted with no need for tools		Service access optionally from the front or rear	
Up to 33% larger gland plates support cable entry with ever-higher packing densities	482.6 mm (19") mounting angles prefitted and ready to use	Cut-out for support arm connection in the enclosure roof, may also be used for the pedestal by rotating the enclosure	
from page 20	from page 40	from page 42	

Top customer benefits



Small enclosures KX			
Terminal boxes KX	E-Box KX	Bus enclosures KX	
All enclosure panels may be taken directly from the packaging, without dismantling, and machined			
The support rails may optionally be fitted on the integral perforated mounting strip or, to maximise the enclosure depth, directly onto the rear wall of the enclosure	The mounting plate is simply slotted in from the front and secured directly in front of the rear panel in a space-saving solution	The support rails may optionally be fitted on the integral perforated mounting strip or, to maximise the enclosure depth, directly onto the rear wall of the enclosure	
Wall mounting brackets are easily secured from the outside with a self-tapping screw			
A QR code on the enclosure, door or cover and mounting plate allows seamless monitoring, from receipt of the incoming goods through to delivery of the finished product			
Earthing points accessible from the front facilitate fast, secure mounting of the earth straps			
The mini cam lock may be fitted without using tools, and ensures that the cover is securely seated and centred when latching	The 180° hinges are already prefitted on the door and ready to use, the cam locks may be attached without the use of tools, and the door is easily fitted	The 180° hinges are already prefitted on the door ready to use, the mini cam locks may be attached without the use of tools, and the door is easily fitted	
from page 96	from page 106	from page 114	



COMPACT ENCLOSURES AX – MORE **EFFICIENT**

Customised interior installation without machining and a wall-mounting system that is revolutionary in its simplicity save even more time.





RITTAL



Equipped for all requirements

AX – the first compact enclosure with a 25 mm pitch pattern system

The AX compact enclosure series is setting new standards. With integral enclosure bosses, it has the same 25 mm pitch pattern system as Rittal's large enclosures. This unique, patented system equips AX compact enclosures for all types of configurations and refits.

System components and accessories are easily, quickly and securely installed and retrofitted using standardised rails, with no drilling required.

Our unique, innovative compact system is designed for maximum efficiency and flexibility and future-proof enclosure manufacturing.

www.rittal.com/ax_assambly_video

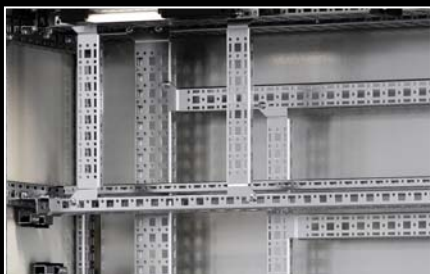

Component installation without drilling

The interior installation rails allow simple, secure, almost effortless configuration of AX compact enclosures on a 25 mm pitch pattern, even retrospectively. All extra work steps such as marking out holes, drilling, deburring and paintwork touch-ups have been eliminated.



Systematic, flexible mounting

The combination of bosses and rail provides maximum flexibility for your enclosure installation. The configuration of each AX compact enclosure can be tailored to individual customer requirements almost without limitation.



One industry-wide standard

With a wide choice of variants and versatile installation options, AX compact enclosures are suitable for use in any industry, at any location, in any climate and in any environment.

Time saving

Thanks to the process-optimised packaging concept, production can get started straight away because all panels and cam locks are delivered disassembled, thereby removing the need for dismantling.

Flexibility

Integrated locators in the housing enable the precise, time-saving incorporation of the interior installation rails used to fit out enclosures with punched sections with mounting flanges and accessories from Rittal.

Stability

Interior installation rails that can be mechanically locked in place at a range of heights using the consistent pattern of integrated locators provide added stability, especially in the case of dynamic loads.

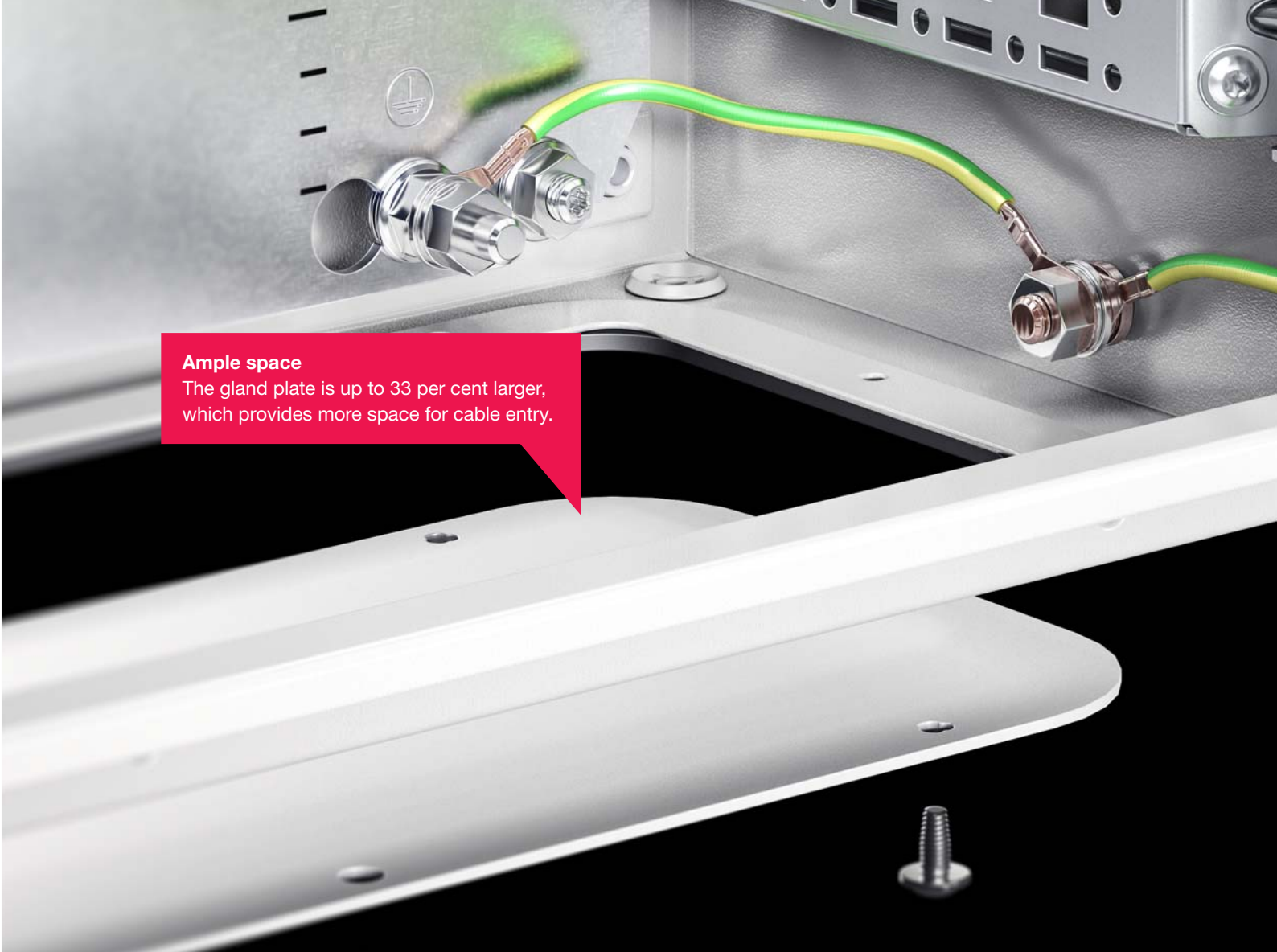

Ample space

The gland plate is up to 33 per cent larger, which provides more space for cable entry.



Reliability

The deliberately slimline enclosure edge fold provides broad, secure contact with the seamless PU foam seal and helps preserve the protection category (up to IP 66) and protection class IK 10.



Potential equalisation

Special drilled holes in the gland plate ensure automatic potential equalisation during screw-fastening, which saves time and materials as well as enhancing safety.

Easy assembly

Tool-free door assembly saves even more time. Once the door has been positioned, the hinge pin simply needs to be pressed in to complete the process.

Flexibility

The AX door hinge allows you to swap the hinge to the opposite side, even with two-door enclosures, without any machining of the enclosure. This makes it quick and easy to switch the lockable door, and can also free up additional space by allowing the installation of components/accessories on the door.

Extra security

The stable rod locking mechanism (fitted) with three locking points offers additional security on AX enclosures with a height of 1200 mm or more.

Time saving

Supplying the cam locks loose eliminates potential obstructions when machining the door and removes the need for time-consuming dismantling work beforehand.

Fast installation

Lock installation is fast and tool-free. Following insertion, it simply needs to be locked in place and it's ready.



Larger surfaces

Thanks to its compatibility with Rittal system accessories, the perforated door strip with U-section and system punching in a versatile 25 mm pitch pattern makes it quick and easy to create more installation space without machining the door.



A good fit

Even when heavy components are mounted on doors, the runner on the perforated door strip ensures precise door positioning so as to maintain the protection category.



Labour-saving

Easy dismantling of the fastening screw on the enclosure hinge makes it quick and straightforward to switch the door hinge to the other side. The door is not pre-installed, so there is no dismantling to add to the workload.



Wide angle

The normal door opening angle of 130° can be increased if necessary by replacing the standard hinge with a 180° hinge from the Rittal accessories portfolio.



Convenient fixing

The mounting plate is easy to pre-attach and secure firmly in place simply by inserting it from above.



Full utilisation of space

The option of screw-fastening the mounting plate directly onto the rear panel can increase the overall installation depth by 8 mm.





Straightforward earthing

The machined keyhole makes it much easier to earth the mounting plate with automatic potential equalisation and this can even be done after the mounting plate has been screwed into place.



Easy assembly

The standard eyelet in the rear panel allows rapid screw-fastening of the wall mounting bracket from the outside with a self-tapping screw; no need for a lock nut on the inside. The high protection category is retained in full.

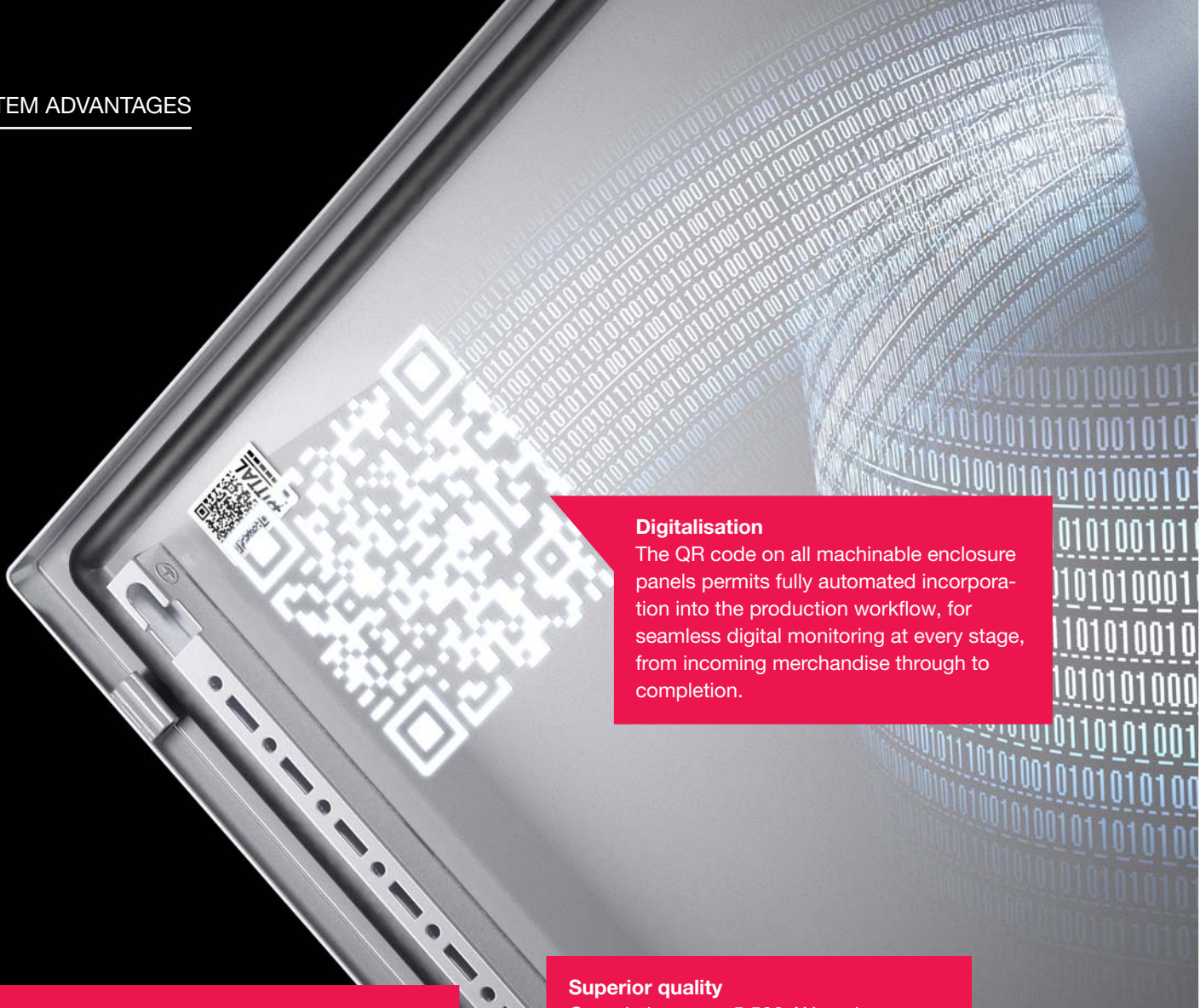

Digitalisation

The QR code on all machinable enclosure panels permits fully automated incorporation into the production workflow, for seamless digital monitoring at every stage, from incoming merchandise through to completion.

Variety of industries

The versatility of the different variants allows the AX to be used in any industry, at any location, in any climate, in any environment, and in a wide range of individual applications.



Superior quality

Completing up to 5,500 AX enclosures per day, the world's most state-of-the-art Industry 4.0 mass production operation for compact enclosures ensures consistently high quality.



Compact and small enclosures

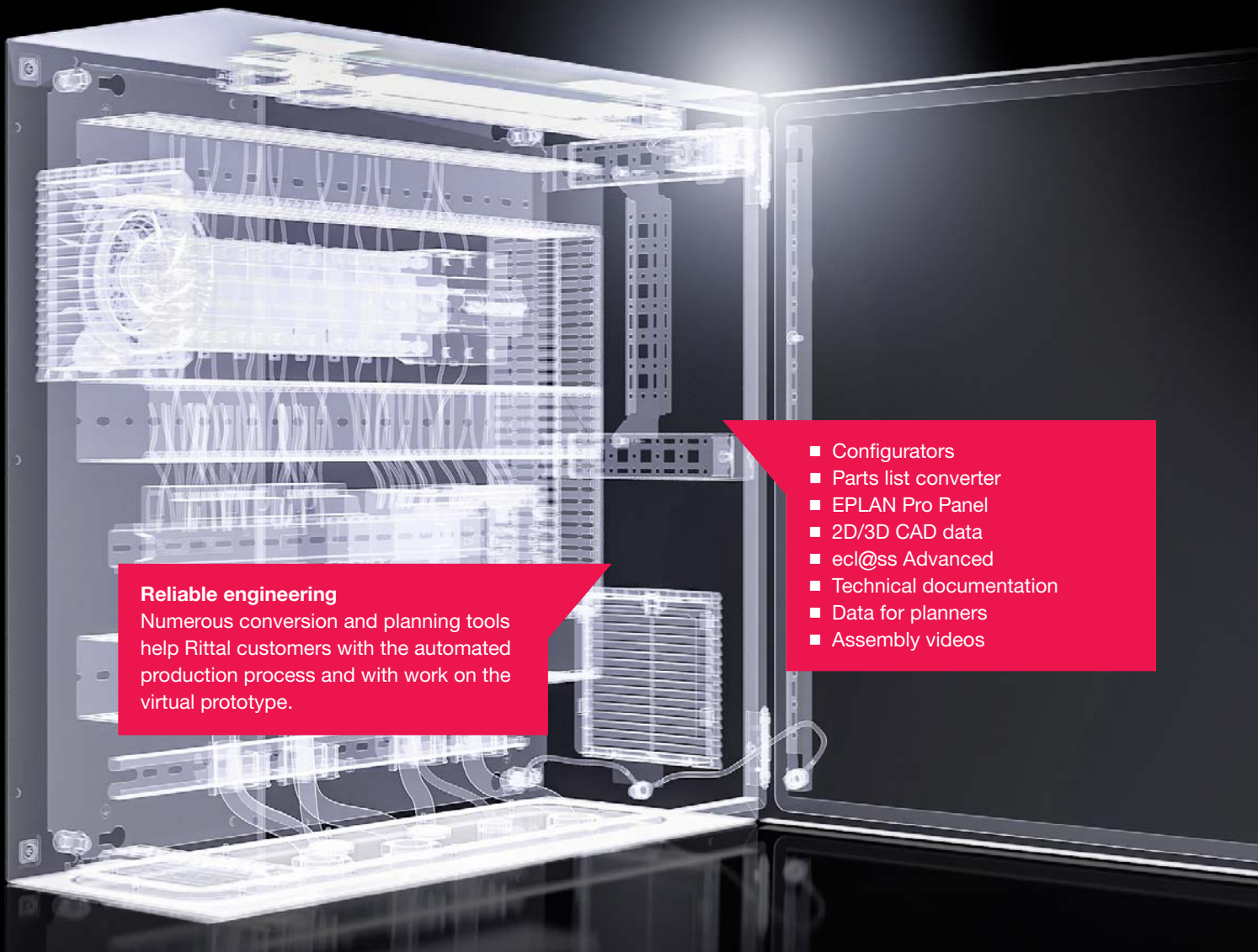

Reliable engineering
Numerous conversion and planning tools help Rittal customers with the automated production process and with work on the virtual prototype.

- Configurators
- Parts list converter
- EPLAN Pro Panel
- 2D/3D CAD data
- ecl@ss Advanced
- Technical documentation
- Data for planners
- Assembly videos



Corrosion protection
The three-stage surface treatment process guarantees maximum protection against corrosion and is resistant to mineral oils, lubricants, machining emulsions and most solvents.

- 1 Nanoceramic treatment
- 2 Electrophoretic dipcoat priming
- 3 Powder coating



Quality assurance
Rittal has its own accredited test laboratory, which repeatedly simulates the toughest conditions of all relevant sectors and applications so as to ensure high AX quality on a continuous and lasting basis.

Compact enclosures AX



System accessories Page 60

Material:

- Enclosure: Sheet steel
- Door: Sheet steel, all-round foamed-in PU seal

Surface finish:

- Enclosure and door: Dipcoat-primed, powder-coated on the outside, textured paint
- Mounting plate: Zinc-plated

Colour:

- RAL 7035

Supply includes:

- Enclosure with door(s)
 - Gland plate(s) in enclosure base
 - Mounting plate
 - Perforated door strip
 - Lock: 3 mm double-bit
- Please note the product-specific scope of supply.

Approvals:

- UL
 - cUL
 - Bureau Veritas
 - Lloyds Register
 - DNV-GL
- Further approvals can be found on the Internet.

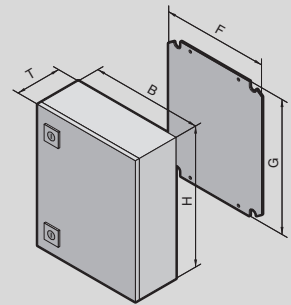

Compact enclosures AX

Basic enclosure AX, sheet steel

Width (B) mm	Packs of	300	300	Page
Height (H) mm		300	400	
Depth (T) mm		210	210	
Mounting plate width (F) mm		250	250	
Mounting plate height (G) mm		275	375	
Material thickness – enclosure mm		1.25	1.25	
Material thickness – door mm		1.5	1.5	
Material thickness – mounting plate mm		2.0	2.0	
Model No.	1 pc(s).	1033.000	1034.000	
Weight kg		6.7	8.38	
IP protection category to IEC 60 529		IP 66	IP 66	
Protection category NEMA		NEMA 4	NEMA 4	
Product-specific scope of supply				
Door(s)		1	1	
Door hinged on the right, may be swapped to the left				
Gland plate, size		1	1	
Gland plate, qty		1	1	
Cam lock		1	1	
Accessories				
Wall mounting bracket, for AX sheet steel, KX sheet steel, wall distance 20 mm	4 pc(s).	2508.020	2508.020	73
Wall mounting bracket, for AX sheet steel, KX sheet steel, wall distance 40 mm	4 pc(s).	2503.020	2503.020	73
Wall angle	4 pc(s).	2505.510	2505.510	74
Pole clamp	2 pc(s).	2584.100	2584.100	74
Plastic gland plate, modular	1 pc(s).	2561.200	2561.200	90
Plastic gland plate with membranes	1 pc(s).	2561.300	2561.300	90
Metal gland plate with knockouts	1 pc(s).	2571.100	2571.100	91
Sealing frame, modular		see page	see page	87
Rail for interior installation	4 pc(s).	2394.210	2394.210	77
Support strips, installation in the door		–	–	
Punched section with mounting flange 14 x 39 mm, installation in the height	4 pc(s).	–	8619.700	78
Punched section with mounting flange 14 x 39 mm, installation in the door		–	–	
LED system light		–	–	
Mini-comfort handle AX for lock inserts or profile half-cylinders	1 pc(s).	2537.100	2537.100	66
Mini-comfort handle AX for padlock and lock inserts or profile half-cylinders	1 pc(s).	2537.300	2537.300	66
Comfort handle AX for lock inserts or profile half-cylinders		–	–	
Comfort handle AX with security lock insert, lock E1		–	–	
Comfort handle AX for padlock and lock inserts or profile half-cylinders		–	–	
Lock inserts		see page	see page	67
Viewing window, depth 36 mm		–	–	
Viewing window, depth 62 mm		–	–	
Operating panel		–	–	
180° hinge	3 pc(s).	2449.010	2449.010	68
Door stay	1 pc(s).	2519.020	2519.020	70
Sheet steel wiring plan pockets, width-variable		–	–	
Plastic wiring plan pockets		see page	see page	70
Wiring plan pockets with transparent pouch		see page	see page	70
Base/plinth corner pieces with base/plinth trim panel, front and rear, 100 mm		–	–	
Base/plinth trim panels, side, 100 mm		–	–	
Base/plinth corner pieces with base/plinth trim panel, front and rear, 200 mm		–	–	
Base/plinth trim panels, side, 200 mm		–	–	
Eyebolts		–	–	
Protective roof	1 pc(s).	2361.010	2361.010	71
Dust guard trim	1 pc(s).	2426.500	2426.500	71
Earth straps		see page	see page	84
Baying kit	1 pc(s).	1199.100	1199.100	62
Cable gland, brass		see page	see page	93
Cable gland, polyamide		see page	see page	93

Compact enclosures AX

Basic enclosure AX, sheet steel

Width (B) mm	Packs of	380	380	380	380	400	400	Page
Height (H) mm		300	380	600	600	500	800	
Depth (T) mm		210	210	210	350	210	300	
Mounting plate width (F) mm		330	330	330	330	350	345	
Mounting plate height (G) mm		275	355	575	575	475	775	
Material thickness – enclosure mm		1.25	1.25	1.25	1.5	1.25	1.5	
Material thickness – door mm		1.5	1.5	1.5	1.5	1.5	2.0	
Material thickness – mounting plate mm		2.0	2.0	2.5	2.5	2.0	2.5	
Model No.	1 pc(s).	1031.000	1380.000	1038.000	1338.000	1045.000	1037.000	
Weight kg		8.8	9.48	14.4	18.6	12.1	24.9	
IP protection category to IEC 60 529		IP 66	IP 66	IP 66	IP 66	IP 66	IP 66	
Protection category NEMA		NEMA 4	NEMA 4	NEMA 4	NEMA 4	NEMA 4	NEMA 4	
Product-specific scope of supply								
Door(s)		1	1	1	1	1	1	
Door hinged on the right, may be swapped to the left								
Gland plate, size		2	2	2	5	2	5	
Gland plate, qty		1	1	1	1	1	1	
Cam lock		1	1	2	2	2	2	
Accessories								
Wall mounting bracket, for AX sheet steel, KX sheet steel, wall distance 20 mm	4 pc(s).	2508.020	2508.020	2508.020	2508.020	2508.020	2508.020	73
Wall mounting bracket, for AX sheet steel, KX sheet steel, wall distance 40 mm	4 pc(s).	2503.020	2503.020	2503.020	2503.020	2503.020	2503.020	73
Wall angle	4 pc(s).	2505.510	2505.510	2505.510	2505.510	2505.510	2505.510	74
Pole clamp	2 pc(s).	2584.100	2584.100	2584.100	2584.100	2584.100	2584.100	74
Plastic gland plate, modular	1 pc(s).	2562.200	2562.200	2562.200	2565.200	2562.200	2565.200	90
Plastic gland plate with membranes	1 pc(s).	2562.300	2562.300	2562.300	2565.300	2562.300	2565.300	90
Metal gland plate with knockouts	1 pc(s).	2572.100	2572.100	2572.100	2575.100	2572.100	2575.100	91
Sealing frame, modular		see page	see page	see page	see page	see page	see page	87
Rail for interior installation	4 pc(s).	2394.210	2394.210	2394.210	2394.350	2394.210	2394.300	77
Support strips, installation in the door	20 pc(s).	4599.100	4599.100	4599.100	4599.100	4694.000	4694.000	69
Punched section with mounting flange 14 x 39 mm, installation in the height	4 pc(s).	–	–	–	–	8619.710	8619.730	78
Punched section with mounting flange 14 x 39 mm, installation in the door		–	–	–	–	–	–	
LED system light	1 pc(s).	–	–	–	–	2500.100	2500.100	94
Mini-comfort handle AX for lock inserts or profile half-cylinders	1 pc(s).	2537.100	2537.100	2537.100	2537.100	2537.100	2537.100	66
Mini-comfort handle AX for padlock and lock inserts or profile half-cylinders	1 pc(s).	2537.300	2537.300	2537.300	2537.300	2537.300	2537.300	66
Comfort handle AX for lock inserts or profile half-cylinders		–	–	–	–	–	–	
Comfort handle AX with security lock insert, lock E1		–	–	–	–	–	–	
Comfort handle AX for padlock and lock inserts or profile half-cylinders		–	–	–	–	–	–	
Lock inserts		see page	see page	see page	see page	see page	see page	67
Viewing window, depth 36 mm		–	–	–	–	–	–	
Viewing window, depth 62 mm		–	–	–	–	–	–	
Operating panel	1 pc(s).	2741.010	2742.010	2743.010	2743.010	–	–	63
180° hinge	3 pc(s).	2449.010	2449.010	2449.010	2449.010	2449.010	2449.010	68
Door stay	1 pc(s).	2519.020	2519.020	2519.020	2519.020	2519.020	2519.020	70
Sheet steel wiring plan pockets, width-variable	1 pc(s).	–	–	–	–	2515.200	2515.200	70
Plastic wiring plan pockets		see page	see page	see page	see page	see page	see page	70
Wiring plan pockets with transparent pouch		see page	see page	see page	see page	see page	see page	70
Base/plinth corner pieces with base/plinth trim panel, front and rear, 100 mm		–	–	–	–	–	–	
Base/plinth trim panels, side, 100 mm		–	–	–	–	–	–	
Base/plinth corner pieces with base/plinth trim panel, front and rear, 200 mm		–	–	–	–	–	–	
Base/plinth trim panels, side, 200 mm		–	–	–	–	–	–	
Eyebolts		–	–	–	–	–	–	
Protective roof	1 pc(s).	2472.010	2472.010	2472.010	–	–	–	71
Dust guard trim	1 pc(s).	2426.500	2426.500	2426.500	2426.500	2426.500	2426.500	71
Earth straps		see page	see page	see page	see page	see page	see page	84
Baying kit	1 pc(s).	1199.100	1199.100	1199.100	1199.100	1199.100	1199.100	62
Cable gland, brass		see page	see page	see page	see page	see page	see page	93
Cable gland, polyamide		see page	see page	see page	see page	see page	see page	93

Compact enclosures AX

Basic enclosure AX, sheet steel

Width (B) mm	Packs of	500	500	500	600	600	600	Page
Height (H) mm		500	500	700	380	380	600	
Depth (T) mm		210	300	250	210	350	210	
Mounting plate width (F) mm		450	450	450	550	550	550	
Mounting plate height (G) mm		475	475	675	355	355	575	
Material thickness – enclosure mm		1.25	1.5	1.5	1.25	1.5	1.5	
Material thickness – door mm		1.5	1.5	2.0	1.5	1.5	1.5	
Material thickness – mounting plate mm		2.5	2.5	2.5	2.5	2.5	2.5	
Model No.	1 pc(s).	1050.000	1350.000	1057.000	1039.000	1339.000	1060.000	
Weight kg		15.4	19.0	25.0	14.4	8.7	22.3	
IP protection category to IEC 60 529		IP 66	IP 66	IP 66	IP 66	IP 66	IP 66	
Protection category NEMA		NEMA 4	NEMA 4	NEMA 4	NEMA 4	NEMA 4	NEMA 4	
Product-specific scope of supply								
Door(s)		1	1	1	1	1	1	
Door hinged on the right, may be swapped to the left								
Gland plate, size		3	6	3	4	7	4	
Gland plate, qty		1	1	1	1	1	1	
Cam lock		2	2	2	1	1	2	
Accessories								
Wall mounting bracket, for AX sheet steel, KX sheet steel, wall distance 20 mm	4 pc(s).	2508.020	2508.020	2508.020	2508.020	2508.020	2508.020	73
Wall mounting bracket, for AX sheet steel, KX sheet steel, wall distance 40 mm	4 pc(s).	2503.020	2503.020	2503.020	2503.020	2503.020	2503.020	73
Wall angle	4 pc(s).	2505.510	2505.510	2505.510	2505.510	2505.510	2505.510	74
Pole clamp	2 pc(s).	2584.100	2584.100	2584.100	2584.100	2584.100	2584.100	74
Plastic gland plate, modular	1 pc(s).	2563.200	2566.200	2563.200	2564.200	2567.200	2564.200	90
Plastic gland plate with membranes	1 pc(s).	2563.300	2566.300	2563.300	2564.300	2567.300	2564.300	90
Metal gland plate with knockouts	1 pc(s).	2573.100	2576.100	2573.100	2574.100	2577.100	2574.100	91
Sealing frame, modular		see page	see page	see page	see page	see page	see page	87
Rail for interior installation	4 pc(s).	2394.210	2394.300	2394.250	2394.210	2394.350	2394.210	77
Support strips, installation in the door	20 pc(s).	4695.000	4695.000	4695.000	4696.000	4696.000	4696.000	69
Punched section with mounting flange 14 x 39 mm, installation in the height	4 pc(s).	8619.710	8619.710	8619.760	–	–	8619.720	78
Punched section with mounting flange 14 x 39 mm, installation in the door		–	–	–	–	–	–	
LED system light	1 pc(s).	2500.100	2500.100	2500.100	2500.100	2500.100	2500.100	94
Mini-comfort handle AX for lock inserts or profile half-cylinders	1 pc(s).	2537.100	2537.100	2537.100	2537.100	2537.100	2537.100	66
Mini-comfort handle AX for padlock and lock inserts or profile half-cylinders	1 pc(s).	2537.300	2537.300	2537.300	2537.300	2537.300	2537.300	66
Comfort handle AX for lock inserts or profile half-cylinders		–	–	–	–	–	–	
Comfort handle AX with security lock insert, lock E1		–	–	–	–	–	–	
Comfort handle AX for padlock and lock inserts or profile half-cylinders		–	–	–	–	–	–	
Lock inserts		see page	see page	see page	see page	see page	see page	65
Viewing window, depth 36 mm	1 pc(s).	2733.010	2733.010	–	2730.010	2730.010	2731.010	63
Viewing window, depth 62 mm	1 pc(s).	2763.010	2763.010	–	2760.010	2760.010	2761.010	63
Operating panel	1 pc(s).	2745.010	2745.010	–	2744.010	–	2746.010	63
180° hinge	3 pc(s).	2449.010	2449.010	2449.010	2449.010	2449.010	2449.010	68
Door stay	1 pc(s).	2519.020	2519.020	2519.020	2519.020	2519.020	2519.020	70
Sheet steel wiring plan pockets, width-variable	1 pc(s).	2515.200	2515.200	2515.200	2515.300	2515.300	2515.300	70
Plastic wiring plan pockets		see page	see page	see page	see page	see page	see page	70
Wiring plan pockets with transparent pouch		see page	see page	see page	see page	see page	see page	70
Base/plinth corner pieces with base/plinth trim panel, front and rear, 100 mm		–	–	–	–	–	–	
Base/plinth trim panels, side, 100 mm		–	–	–	–	–	–	
Base/plinth corner pieces with base/plinth trim panel, front and rear, 200 mm		–	–	–	–	–	–	
Base/plinth trim panels, side, 200 mm		–	–	–	–	–	–	
Eyebolts		–	–	–	–	–	–	
Protective roof	1 pc(s).	2362.010	–	–	2473.010	–	2473.010	71
Dust guard trim	1 pc(s).	2426.500	2426.500	2426.500	2426.500	2426.500	2426.500	71
Earth straps		see page	see page	see page	see page	see page	see page	84
Baying kit	1 pc(s).	1199.100	1199.100	1199.100	1199.100	1199.100	1199.100	62
Cable gland, brass		see page	see page	see page	see page	see page	see page	93
Cable gland, polyamide		see page	see page	see page	see page	see page	see page	93

Compact enclosures AX

Basic enclosure AX, sheet steel

Width (B) mm	Packs of	600	600	600	600	600	600	Page
Height (H) mm		600	600	760	760	800	800	
Depth (T) mm		250	350	210	350	250	400	
Mounting plate width (F) mm		550	550	550	550	545	545	
Mounting plate height (G) mm		575	575	735	735	775	775	
Material thickness – enclosure mm		1.5	1.5	1.5	1.5	1.5	1.5	
Material thickness – door mm		1.5	1.5	2.0	2.0	2.0	2.0	
Material thickness – mounting plate mm		2.5	2.5	2.5	2.5	2.5	2.5	
Model No.	1 pc(s).	1054.000	1360.000	1076.000	1376.000	1058.000	1059.000	
Weight kg		23.4	26.3	29.5	34.0	32.0	40.0	
IP protection category to IEC 60 529		IP 66	IP 66	IP 66	IP 66	IP 66	IP 66	
Protection category NEMA		NEMA 4	NEMA 4	NEMA 4	NEMA 4	NEMA 4	NEMA 4	
Product-specific scope of supply								
Door(s)		1	1	1	1	1	1	
Door hinged on the right, may be swapped to the left								
Gland plate, size		4	7	4	7	4	7	
Gland plate, qty		1	1	1	1	1	1	
Cam lock		2	2	2	2	2	2	
Accessories								
Wall mounting bracket, for AX sheet steel, KX sheet steel, wall distance 20 mm	4 pc(s).	2508.020	2508.020	2508.020	2508.020	2508.020	2508.020	73
Wall mounting bracket, for AX sheet steel, KX sheet steel, wall distance 40 mm	4 pc(s).	2503.020	2503.020	2503.020	2503.020	2503.020	2503.020	73
Wall angle	4 pc(s).	2505.510	2505.510	2505.510	2505.510	2505.510	2505.510	74
Pole clamp	2 pc(s).	2584.100	2584.100	2584.100	2584.100	2584.100	2584.100	74
Plastic gland plate, modular	1 pc(s).	2564.200	2567.200	2564.200	2567.200	2564.200	2567.200	90
Plastic gland plate with membranes	1 pc(s).	2564.300	2567.300	2564.300	2567.300	2564.300	2567.300	90
Metal gland plate with knockouts	1 pc(s).	2574.100	2577.100	2574.100	2577.100	2574.100	2577.100	91
Sealing frame, modular		see page	see page	see page	see page	see page	see page	87
Rail for interior installation	4 pc(s).	2394.250	2394.350	2394.210	2394.350	2394.250	2394.400	77
Support strips, installation in the door	20 pc(s).	4696.000	4696.000	4696.000	4696.000	4696.000	4696.000	69
Punched section with mounting flange 14 x 39 mm, installation in the height	4 pc(s).	8619.720	8619.720	8619.790	8619.790	8619.730	8619.730	78
Punched section with mounting flange 14 x 39 mm, installation in the door		–	–	–	–	–	–	
LED system light	1 pc(s).	2500.100	2500.100	2500.100	2500.100	2500.110	2500.110	94
Mini-comfort handle AX for lock inserts or profile half-cylinders	1 pc(s).	2537.100	2537.100	2537.100	2537.100	2537.100	2537.100	66
Mini-comfort handle AX for padlock and lock inserts or profile half-cylinders	1 pc(s).	2537.300	2537.300	2537.300	2537.300	2537.300	2537.300	66
Comfort handle AX for lock inserts or profile half-cylinders		–	–	–	–	–	–	
Comfort handle AX with security lock insert, lock E1		–	–	–	–	–	–	
Comfort handle AX for padlock and lock inserts or profile half-cylinders		–	–	–	–	–	–	
Lock inserts		see page	see page	see page	see page	see page	see page	65
Viewing window, depth 36 mm	1 pc(s).	2731.010	2731.010	2732.010	2732.010	–	–	63
Viewing window, depth 62 mm	1 pc(s).	2761.010	2761.010	2762.010	2762.010	–	–	63
Operating panel	1 pc(s).	2746.010	2746.010	–	–	–	–	63
180° hinge	3 pc(s).	2449.010	2449.010	2449.010	2449.010	2449.010	2449.010	68
Door stay	1 pc(s).	2519.020	2519.020	2519.020	2519.020	2519.020	2519.020	70
Sheet steel wiring plan pockets, width-variable	1 pc(s).	2515.300	2515.300	2515.300	2515.300	2515.300	2515.300	70
Plastic wiring plan pockets		see page	see page	see page	see page	see page	see page	70
Wiring plan pockets with transparent pouch		see page	see page	see page	see page	see page	see page	70
Base/plinth corner pieces with base/plinth trim panel, front and rear, 100 mm	2 pc(s).	–	–	–	–	–	2820.061	60
Base/plinth trim panels, side, 100 mm	2 pc(s).	–	–	–	–	–	2820.410	61
Base/plinth corner pieces with base/plinth trim panel, front and rear, 200 mm	2 pc(s).	–	–	–	–	–	2820.062	60
Base/plinth trim panels, side, 200 mm	2 pc(s).	–	–	–	–	–	2820.420	61
Eyebolts	2 pc(s).	–	–	–	–	–	2509.010	72
Protective roof	1 pc(s).	–	2476.010	2473.010	2476.010	–	–	71
Dust guard trim	1 pc(s).	2426.500	2426.500	2426.500	2426.500	2426.500	2426.500	71
Earth straps		see page	see page	see page	see page	see page	see page	84
Baying kit	1 pc(s).	1199.100	1199.100	1199.100	1199.100	1199.100	1199.100	62
Cable gland, brass		see page	see page	see page	see page	see page	see page	93
Cable gland, polyamide		see page	see page	see page	see page	see page	see page	93

Compact enclosures AX

Basic enclosure AX, sheet steel

Width (B) mm	Packs of	600	600	600	600	760	760	Page
Height (H) mm		1000	1000	1200	1200	760	760	
Depth (T) mm		250	400	300	400	210	300	
Mounting plate width (F) mm		545	545	545	545	705	705	
Mounting plate height (G) mm		975	975	1175	1175	735	735	
Material thickness – enclosure mm		1.5	1.5	1.5	1.5	1.5	1.5	
Material thickness – door mm		2.0	2.0	2.0	2.0	2.0	2.0	
Material thickness – mounting plate mm		2.5	2.5	2.5	2.5	2.5	2.5	
Model No.	1 pc(s).	1090.000	1091.000	1260.000	1261.000	1077.000	1073.000	
Weight kg		39.5	50.0	50.0	56.0	36.7	42.0	
IP protection category to IEC 60 529		IP 66	IP 66	IP 66	IP 66	IP 66	IP 66	
Protection category NEMA		NEMA 4	NEMA 4	NEMA 4	NEMA 4	NEMA 4	NEMA 4	
Product-specific scope of supply								
Door(s)		1	1	1	1	1	1	
Door hinged on the right, may be swapped to the left								
Gland plate, size		4	7	7	7	2	5	
Gland plate, qty		1	1	1	1	2	2	
Cam lock		2	2	–	–	2	2	
3-point lock system		–	–			–	–	
Accessories								
Wall mounting bracket, for AX sheet steel, KX sheet steel, wall distance 20 mm	4 pc(s).	2508.020	2508.020	2508.020	2508.020	2508.020	2508.020	73
Wall mounting bracket, for AX sheet steel, KX sheet steel, wall distance 40 mm	4 pc(s).	2503.020	2503.020	2503.020	2503.020	2503.020	2503.020	73
Wall angle	4 pc(s).	2505.510	2505.510	2505.510	2505.510	2505.510	2505.510	74
Pole clamp	2 pc(s).	2584.100	2584.100	2584.100	2584.100	–	–	74
Plastic gland plate, modular	1 pc(s).	2564.200	2567.200	2567.200	2567.200	2562.200	2565.200	90
Plastic gland plate with membranes	1 pc(s).	2564.300	2567.300	2567.300	2567.300	2562.300	2565.300	90
Metal gland plate with knockouts	1 pc(s).	2574.100	2577.100	2577.100	2577.100	2572.100	2575.100	90
Sealing frame, modular		see page	see page	see page	see page	see page	see page	87
Rail for interior installation	4 pc(s).	2394.250	2394.400	2394.300	2394.400	2394.210	2394.300	77
Support strips, installation in the door	20 pc(s).	4696.000	4696.000	4596.000	4596.000	4599.200	4599.200	69
Punched section with mounting flange 14 x 39 mm, installation in the height	4 pc(s).	8619.750	8619.750	8619.770	8619.770	8619.790	8619.790	78
Punched section with mounting flange 14 x 39 mm, installation in the door	4 pc(s).	–	–	8619.720	8619.720	–	–	78
LED system light	1 pc(s).	2500.110	2500.110	2500.110	2500.110	2500.110	2500.110	94
Mini-comfort handle AX for lock inserts or profile half-cylinders	1 pc(s).	2537.100	2537.100	–	–	2537.100	2537.100	66
Mini-comfort handle AX for padlock and lock inserts or profile half-cylinders	1 pc(s).	2537.300	2537.300	–	–	2537.300	2537.300	66
Comfort handle AX for lock inserts or profile half-cylinders	1 pc(s).	–	–	2435.100	2435.100	–	–	65
Comfort handle AX with security lock insert, lock E1	1 pc(s).	–	–	2435.200	2435.200	–	–	
Comfort handle AX for padlock and lock inserts or profile half-cylinders	1 pc(s).	–	–	2435.400	2435.400	–	–	65
Lock inserts		see page	see page	see page	see page	see page	see page	67
Viewing window, depth 36 mm		–	–	–	–	–	–	
Viewing window, depth 62 mm		–	–	–	–	–	–	
Operating panel		–	–	–	–	–	–	
180° hinge	3 pc(s).	2449.010	2449.010	2449.010	2449.010	2449.010	2449.010	68
Door stay	1 pc(s).	2519.020	2519.020	2519.020	2519.020	2519.020	2519.020	70
Sheet steel wiring plan pockets, width-variable	1 pc(s).	2515.300	2515.300	2515.300	2515.300	2515.400	2515.400	70
Plastic wiring plan pockets		see page	see page	see page	see page	see page	see page	70
Wiring plan pockets with transparent pouch		see page	see page	see page	see page	see page	see page	70
Base/plinth corner pieces with base/plinth trim panel, front and rear, 100 mm	2 pc(s).	–	2820.061	2820.061	2820.061	–	–	60
Base/plinth trim panels, side, 100 mm	2 pc(s).	–	2820.410	2820.310	2820.410	–	–	61
Base/plinth corner pieces with base/plinth trim panel, front and rear, 200 mm	2 pc(s).	–	2820.062	2820.062	2820.062	–	–	60
Base/plinth trim panels, side, 200 mm	2 pc(s).	–	2820.420	2820.320	2820.420	–	–	61
Eyebolts	2 pc(s).	–	2509.010	2509.010	2509.010	–	–	72
Protective roof	1 pc(s).	–	–	–	–	–	2474.010	71
Dust guard trim	1 pc(s).	2426.500	2426.500	2426.500	2426.500	2426.500	2426.500	71
Earth straps		see page	see page	see page	see page	see page	see page	84
Baying kit	1 pc(s).	1199.100	1199.100	1199.100	1199.100	1199.100	1199.100	62
Cable gland, brass		see page	see page	see page	see page	see page	see page	93
Cable gland, polyamide		see page	see page	see page	see page	see page	see page	93

Compact enclosures AX

Basic enclosure AX, sheet steel

Width (B) mm	Packs of	800	800	800	800	800	1000	Page
Height (H) mm		600	1000	1000	1200	1200	760	
Depth (T) mm		300	300	400	300	400	210	
Mounting plate width (F) mm		750	745	745	745	745	945	
Mounting plate height (G) mm		575	975	975	1175	1175	735	
Material thickness – enclosure mm		1.5	1.5	1.5	1.5	1.5	1.5	
Material thickness – door mm		2.0	2.0	2.0	2.0	2.0	2.0	
Material thickness – mounting plate mm		2.5	2.5	2.5	2.5	2.5	2.5	
Model No.	1 pc(s).	1055.000	1180.000	1181.000	1280.000	1281.000	1100.000	
Weight kg		34.2	52.0	59.5	63.5	69.0	49.0	
IP protection category to IEC 60 529		IP 66	IP 66	IP 66	IP 66	IP 66	IP 55	
Protection category NEMA		NEMA 4	NEMA 4	NEMA 4	NEMA 4	NEMA 4	NEMA 12	
Product-specific scope of supply								
Door(s)		1	1	1	1	1	2	
Door hinged on the right, may be swapped to the left								
Gland plate, size		5	5	5	5	5	3	
Gland plate, qty		2	2	2	2	2	2	
Cam lock		2	2	2	–	–	2	
3-point lock system		–	–	–			–	
Accessories								
Wall mounting bracket, for AX sheet steel, KX sheet steel, wall distance 20 mm	4 pc(s).	2508.020	2508.020	2508.020	2508.020	2508.020	2508.020	73
Wall mounting bracket, for AX sheet steel, KX sheet steel, wall distance 40 mm	4 pc(s).	2503.020	2503.020	2503.020	2503.020	2503.020	2503.020	73
Wall angle	4 pc(s).	2505.510	2505.510	2505.510	2505.510	2505.510	2505.510	74
Pole clamp	2 pc(s).	2584.100	2584.100	2584.100	2584.100	2584.100	2584.100	74
Plastic gland plate, modular	1 pc(s).	2565.200	2565.200	2565.200	2565.200	2565.200	2562.200	90
Plastic gland plate with membranes	1 pc(s).	2565.300	2565.300	2565.300	2565.300	2565.300	2563.300	90
Metal gland plate with knockouts	1 pc(s).	2575.100	2575.100	2575.100	2575.100	2575.100	2573.100	90
Sealing frame, modular		see page	see page	see page	see page	see page	see page	87
Rail for interior installation	4 pc(s).	2394.300	2394.300	2394.400	2394.300	2394.400	2394.210	77
Support strips, installation in the door	20 pc(s).	4697.000	4697.000	4697.000	–	–	4695.000	69
Punched section with mounting flange 14 x 39 mm, installation in the height	4 pc(s).	8619.720	8619.750	8619.750	8619.770	8619.770	8619.790	78
Punched section with mounting flange 14 x 39 mm, installation in the door ¹⁾	4 pc(s).	–	–	–	8619.730	8619.730	8619.710	78
LED system light	1 pc(s).	2500.110	2500.110	2500.110	2500.110	2500.110	2500.110	94
Mini-comfort handle AX for lock inserts or profile half-cylinders	1 pc(s).	2537.100	2537.100	2537.100	–	–	2537.100	66
Mini-comfort handle AX for padlock and lock inserts or profile half-cylinders	1 pc(s).	2537.300	2537.300	2537.300	–	–	2537.300	66
Comfort handle AX for lock inserts or profile half-cylinders	1 pc(s).	–	–	–	2435.100	2435.100	–	66
Comfort handle AX with security lock insert, lock E1	1 pc(s).	–	–	–	2435.200	2435.200	–	
Comfort handle AX for padlock and lock inserts or profile half-cylinders	1 pc(s).	–	–	–	2435.400	2435.400	–	65
Lock inserts		see page	see page	see page	see page	see page	see page	65
Viewing window, depth 36 mm		–	–	–	–	–	–	
Viewing window, depth 62 mm		–	–	–	–	–	–	
Operating panel		–	–	–	–	–	–	
180° hinge	3 pc(s).	2449.010	2449.010	2449.010	2449.010	2449.010	2449.010	68
Door stay	1 pc(s).	2519.020	2519.020	2519.020	2519.020	2519.020	2519.020	70
Sheet steel wiring plan pockets, width-variable	1 pc(s).	2515.400	2515.400	2515.400	2515.400	2515.400	2515.200	70
Plastic wiring plan pockets		see page	see page	see page	see page	see page	see page	70
Wiring plan pockets with transparent pouch		see page	see page	see page	see page	see page	see page	70
Base/plinth corner pieces with base/plinth trim panel, front and rear, 100 mm	2 pc(s).	2820.081	2820.081	2820.081	2820.081	2820.081	–	60
Base/plinth trim panels, side, 100 mm	2 pc(s).	2820.310	2820.310	2820.410	2820.310	2820.410	–	61
Base/plinth corner pieces with base/plinth trim panel, front and rear, 200 mm	2 pc(s).	2820.082	2820.082	2820.082	2820.082	2820.082	–	60
Base/plinth trim panels, side, 200 mm	2 pc(s).	2820.320	2820.320	2820.420	2820.320	2820.420	–	61
Eyebolts	2 pc(s).	–	2509.010	2509.010	2509.010	2509.010	–	72
Protective roof	1 pc(s).	2475.010	2475.010	–	2475.010	–	–	71
Dust guard trim	1 pc(s).	2426.500	2426.500	2426.500	2426.500	2426.500	2426.500	71
Earth straps		see page	see page	see page	see page	see page	see page	84
Baying kit	1 pc(s).	1199.100	1199.100	1199.100	1199.100	1199.100	1199.100	62
Cable gland, brass		see page	see page	see page	see page	see page	see page	93
Cable gland, polyamide		see page	see page	see page	see page	see page	see page	93

¹⁾ For two-door enclosures: Installation in the lockable door

Compact enclosures AX

Basic enclosure AX, sheet steel

Width (B) mm	Packs of	1000	1000	1000	1000	1000	1000	1200	Page
Height (H) mm		760	1000	1200	1200	1400	1400	1200	
Depth (T) mm		300	300	300	400	300	400	400	
Mounting plate width (F) mm		945	945	945	945	945	945	1145	
Mounting plate height (G) mm		735	975	1175	1175	1375	1375	1175	
Material thickness – enclosure mm		1.5	1.5	1.5	1.5	1.5	1.5	1.5	
Material thickness – door mm		2.0	2.0	2.0	2.0	2.0	2.0	2.0	
Material thickness – mounting plate mm		2.5	2.5	2.5	2.5	2.5	2.5	2.5	
Model No.	1 pc(s).	1130.000	1110.000	1213.000	1214.000	1114.000	1115.000	1116.000	
Weight kg		52.0	63.0	81.0	85.7	88.5	100.0	101.0	
IP protection category to IEC 60 529		IP 55	IP 55	IP 55	IP 55	IP 55	IP 55	IP 55	
Protection category NEMA		NEMA 12	NEMA 12	NEMA 12	NEMA 12	NEMA 12	NEMA 12	NEMA 12	
Product-specific scope of supply									
Door(s)		2	2	2	2	2	2	2	
Door hinged on the right, may be swapped to the left									
Gland plate, size		6	6	6	6	6	6	7	
Gland plate, qty		2	2	2	2	2	2	2	
Cam lock		2	2	–	–	–	–	–	
3-point lock system		–	–						
Accessories									
Wall mounting bracket, for AX sheet steel, KX sheet steel, wall distance 20 mm	4 pc(s).	2508.020	2508.020	2508.020	2508.020	2508.020	2508.020	2508.020	73
Wall mounting bracket, for AX sheet steel, KX sheet steel, wall distance 40 mm	4 pc(s).	2503.020	2503.020	2503.020	2503.020	2503.020	2503.020	2503.020	73
Wall angle	4 pc(s).	2505.510	2505.510	2505.510	2505.510	2505.510	2505.510	2505.510	74
Pole clamp		–	–	–	–	–	–	–	
Plastic gland plate, modular	1 pc(s).	2566.200	2566.200	2566.200	2566.200	2566.200	2566.200	2567.200	90
Plastic gland plate with membranes	1 pc(s).	2566.300	2566.300	2566.300	2566.300	2566.300	2566.300	2567.300	90
Metal gland plate with knockouts	1 pc(s).	2576.100	2576.100	2576.100	2576.100	2576.100	2576.100	2577.100	91
Sealing frame, modular		see page	see page	see page	see page	see page	see page	see page	87
Rail for interior installation	4 pc(s).	2394.300	2394.300	2394.300	2394.400	2394.300	2394.400	2394.400	77
Support strips, installation in the door	20 pc(s).	4695.000	4695.000	–	–	–	–	–	69
Punched section with mounting flange 14 x 39 mm, installation in the height	4 pc(s).	8619.790	8619.750	8619.770	8619.770	8619.780	8619.780	8619.770	78
Punched section with mounting flange 14 x 39 mm, installation in the door ¹⁾	4 pc(s).	8619.710	8619.710	8619.710	8619.710	8619.710	8619.710	8619.720	78
LED system light	1 pc(s).	2500.110	2500.110	2500.110	2500.110	2500.110	2500.110	2500.110	94
Mini-comfort handle AX for lock inserts or profile half-cylinders	1 pc(s).	2537.100	2537.100	–	–	–	–	–	66
Mini-comfort handle AX for padlock and lock inserts or profile half-cylinders	1 pc(s).	2537.300	2537.300	–	–	–	–	–	66
Comfort handle AX for lock inserts or profile half-cylinders	1 pc(s).	–	–	2435.100	2435.100	2435.100	2435.100	2435.100	65
Comfort handle AX with security lock insert, lock E1	1 pc(s).	–	–	2435.200	2435.200	2435.200	2435.200	2435.200	
Comfort handle AX for padlock and lock inserts or profile half-cylinders	1 pc(s).	–	–	2435.400	2435.400	2435.400	2435.400	2435.400	65
Lock inserts		see page	see page	see page	see page	see page	see page	see page	67
Viewing window, depth 36 mm		–	–	–	–	–	–	–	
Viewing window, depth 62 mm		–	–	–	–	–	–	–	
Operating panel		–	–	–	–	–	–	–	
180° hinge	3 pc(s).	2449.010	2449.010	2449.010	2449.010	2449.010	2449.010	2449.010	68
Door stay	1 pc(s).	2519.020	2519.020	2519.020	2519.020	2519.020	2519.020	2519.020	70
Sheet steel wiring plan pockets, width-variable	1 pc(s).	2515.200	2515.200	2515.200	2515.200	2515.200	2515.200	2515.300	70
Plastic wiring plan pockets		see page	see page	see page	see page	see page	see page	see page	70
Wiring plan pockets with transparent pouch		see page	see page	see page	see page	see page	see page	see page	70
Base/plinth corner pieces with base/plinth trim panel, front and rear, 100 mm	2 pc(s).	2820.101	2820.101	2820.101	2820.101	2820.101	2820.101	2820.121	60
Base/plinth trim panels, side, 100 mm	2 pc(s).	2820.310	2820.310	2820.310	2820.410	2820.310	2820.410	2820.410	61
Base/plinth corner pieces with base/plinth trim panel, front and rear, 200 mm	2 pc(s).	2820.102	2820.102	2820.102	2820.102	2820.102	2820.102	2820.122	60
Base/plinth trim panels, side, 200 mm	2 pc(s).	2820.320	2820.320	2820.320	2820.420	2820.320	2820.420	2820.420	61
Eyebolts	2 pc(s).	–	2509.010	2509.010	2509.010	2509.010	2509.010	2509.010	72
Protective roof	1 pc(s).	2363.010	2363.010	2363.010	–	2363.010	–	–	71
Dust guard trim	1 pc(s).	2426.500	2426.500	2426.500	2426.500	2426.500	2426.500	2426.500	71
Earth straps		see page	see page	see page	see page	see page	see page	see page	84
Baying kit	1 pc(s).	1199.100	1199.100	1199.100	1199.100	1199.100	1199.100	1199.100	62
Cable gland, brass		see page	see page	see page	see page	see page	see page	see page	93
Cable gland, polyamide		see page	see page	see page	see page	see page	see page	see page	93

¹⁾ For two-door enclosures: Installation in the lockable door

Wall-mounted enclosures AX IT



System accessories Page 60

IT wall-mounted enclosure based on AX, with high protection category, for use in industrial environments.

Applications:

- IT enclosure for use in industrial environments
- Secure, protected integration of IT directly into your production plant processes

Benefits:

- Fully pre-assembled IT enclosure for immediate accommodation of 482.6 mm (19") IT components, with depth-variable mounting angles
- Welded enclosure construction with all-round solid body ensures maximum protection for installed components, up to IP 66
- Door hinged on the right, may be swapped to the left
- Maximum usable interior volume with an extremely compact design
- Individual interior configuration
- Maximum cut-out in the enclosure base with optimised gland plates increases the space for cable routing by up to 33%
- Convenient cable entry from below via a gland plate with integral brush strip

Installation options:

- Pre-configured mounting bracket including C rail for cable clamping
- Mounting bracket to accommodate a central earth rail
- Mounting bracket for mounting a 482.6 mm (19") socket strip

Material:

- Sheet steel

Surface finish:

- Enclosure and door: Dipcoat-primed, powder-coated on the outside, textured paint
- Interior installation: Zinc-plated

Colour:

- RAL 7035

Protection category IP to IEC 60 529:

- IP 10 (up to IP 66 on request)
- Up to IP 66 (depending on the selected gland plate)

Supply includes:

- Pre-assembled IT enclosure with hinged door, of all-round solid construction
- Cam lock with 3 mm double-bit insert
- Gland plate with brush strip
- 482.6 mm (19") mounting angles, front, depth-variable on a 25 mm pitch pattern, mounted on four interior installation rails
- Mounting bracket
- C rail, fastened to the rear panel

Note:

- Variant with UL approval available on request

with 482.6 mm (19") mounting angles, depth-variable

Height units U	Packs of	7	12	15	15	Page
Width mm		600	600	600	600	
Height mm		380	600	760	800	
Depth mm		350	350	350	400	
Max. installation depth mm		278	278	278	316	
Cam locks		1	2	2	2	
Model No.	1 pc(s).	7641.350	7643.350	7645.350	7646.400	
Gland plate, size		7	7	7	7	
Gland plate, qty		1	1	1	1	
Accessories						
Wall angle	4 pc(s).	2505.510	2505.510	2505.510	2505.510	74
Wall mounting bracket		see page	see page	see page	see page	73
Plastic gland plate	1 pc(s).	2567.200	2567.200	2567.200	2567.200	90
Metal gland plate	1 pc(s).	2577.100	2577.100	2577.100	2577.100	91
Plastic gland plate	1 pc(s).	2567.300	2567.300	2567.300	2567.300	90
Component shelf, pull-out, 2 U	1 pc(s).	5501.635	5501.635	5501.635	5501.635	
Earth rail, horizontal	1 pc(s).	7113.000	7113.000	7113.000	7113.000	
Mini-comfort handle AX	1 pc(s).	2537.100	2537.100	2537.100	2537.100	66
482.6 mm (19") fastener, 1 U	24 pc(s).	2090.000	2090.000	2090.000	2090.000	
Cable management panel	1 pc(s).	5502.205	5502.205	5502.205	5502.205	
Cable management panel with brush strip	1 pc(s).	5302.202	5302.202	5302.202	5302.202	

UL conformity

Guaranteed when Rittal accessory components are used





OPERATING HOUSINGS AX – MORE **ERGONOMIC**

In conjunction with the Rittal support arm system, the integrated support arm connection always ensures the correct viewing angle and is therefore more ergonomic.





Operating housings AX with handle strips



System accessories Page 60

Material:

- Enclosure: Sheet steel
- Door: Sheet steel, all-round foamed-in PU seal
- Handle strips: Aluminium
- Front panel: Aluminium
- Cover caps: Plastic

Surface finish:

- Enclosure and door: Dipcoat-primed, powder-coated on the outside, textured paint
- Handle strip: Natural anodised
- Front panel: Natural anodised

Colour:

- Enclosure and door: RAL 7035
- Cover caps: similar to RAL 7024

Protection category IP to IEC 60 529:

- IP 55

Protection category NEMA:

- NEMA 12

Supply includes:

- Enclosure with door, cut-out and reinforcement for support arm connection $\text{Ø} 130 \text{ mm}$
- Front with maximum cut-out, covered with easily machinable 3 mm aluminium front panel
- Side handle strips and cover caps
- Integral interior installation bracket with system punchings
- Cam lock with 3 mm double-bit insert

Note:

- The support arm connection and door hinge may be swapped over by rotating the enclosure
- Optional: Support arm connection $\text{Ø} 130 \text{ mm}$, pre-formed off-centre in the reinforcement plate, easily drilled out
- Lock systems for servicing access from the rear: Lock insert may be exchanged for mini-comfort handle AX, 27 mm lock inserts, type A
- Lock systems for servicing access from the front: Lock insert may be exchanged for 27 mm lock inserts, type A

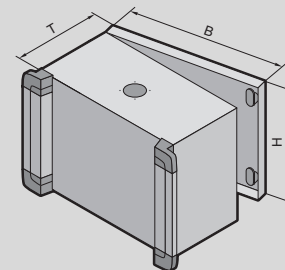
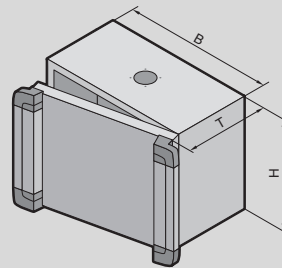

Approvals:

- UL
- cUL

Operating housings AX with handle strips

Width (B) mm	Packs of	300	300	380	380	380	Page
Height (H) mm		200	300	300	380	380	
Depth (T) mm		155	210	210	210	210	
Model No.	1 pc(s).	6320.050	6315.150	6315.250	6315.350	6320.350	
Weight, approx. kg		4.5	7.0	7.5	9.8	9.8	
Servicing access	from the rear		–	–	–		
	from the front		–			–	

Accessories

Punched section with mounting flange 14 x 39 mm, installation in the height	4 pc(s).	–	–	–	8619.700	8619.700	78
Punched section with mounting flange 14 x 39 mm, installation in the width	4 pc(s).	8619.700	8619.700	–	–	–	78
Mounting bracket	4 pc(s).	4597.000	4597.000	4597.000	4597.000	4597.000	81
Mounting bracket for interior installation	4 pc(s).	6205.100	6205.100	6205.100	6205.100	6205.100	81
Mini-comfort handle AX for lock inserts or profile half-cylinders	1 pc(s).	2537.100	2537.100	2537.100	2537.100	2537.100	66
Mini-comfort handle AX for padlock and lock inserts or profile half-cylinders	1 pc(s).	2537.300	2537.300	2537.300	2537.300	2537.300	66
Lock inserts		see page	see page	see page	see page	see page	67
Earth straps		see page	see page	see page	see page	see page	84

Width (B) mm	Packs of	500	500	600	600	600	Page
Height (H) mm		500	500	380	600	600	
Depth (T) mm		210	210	210	210	210	
Model No.	1 pc(s).	6315.450	6320.450	6320.550	6320.650	6315.650	
Weight, approx. kg		16.8	16.8	15.4	18.8	22.8	
Servicing access	from the rear		–			–	
	from the front			–	–	–	

Accessories

Punched section with mounting flange 14 x 39 mm, installation in the height	4 pc(s).	8619.710	8619.710	8619.700	8619.720	8619.720	78
Punched section with mounting flange 14 x 39 mm, installation in the width	4 pc(s).	8619.720	8619.720	8619.760	8619.760	8619.760	78
Mounting bracket	4 pc(s).	4597.000	4597.000	4597.000	4597.000	4597.000	81
Mounting bracket for interior installation	4 pc(s).	6205.100	6205.100	6205.100	6205.100	6205.100	81
Mini-comfort handle AX for lock inserts or profile half-cylinders	1 pc(s).	2537.100	2537.100	2537.100	2537.100	2537.100	66
Mini-comfort handle AX for padlock and lock inserts or profile half-cylinders	1 pc(s).	2537.300	2537.300	2537.300	2537.300	2537.300	66
Lock inserts		see page	see page	see page	see page	see page	67
Earth straps		see page	see page	see page	see page	see page	84

Rittal – The System.



Support arm system CP
60/120/180

see Cat. 36, page 183

Operating housing AX for desktop TFT up to 24"



System accessories Page 60

For the installation of commercially available desktop TFTs with a screen diagonal of up to 24" in the formats 16:9/16:10.

Material:

- Enclosure: Sheet steel
- Door: Sheet steel, all-round foamed-in PU seal
- Handle strips: Aluminium
- Cover caps: Plastic
- Viewing window: Single-pane safety glass
- TFT holder: Sheet steel

Surface finish:

- Enclosure and door: Powder-coated on the outside, textured paint
- Handle strip: Natural anodised

Colour:

- Enclosure and door: RAL 7035
- Cover caps: similar to RAL 7024

Protection category IP to IEC 60 529:

- IP 65

Protection category NEMA:

- NEMA 12

Supply includes:

- Enclosure with door, cut-out and reinforcement for support arm connection Ø 130 mm
- Viewing window, single-pane safety glass
- Holder for desktop TFT with VESA 75/100 locator
- Side handle strips and cover caps
- Rear door with r/h hinge
- Cam lock with 3 mm double-bit insert

Note:

- The support arm connection and door hinge may be swapped over by rotating the enclosure
- Optional: Support arm connection Ø 130 mm, pre-formed off-centre in the reinforcement plate, easily drilled out
- Lock insert may be exchanged for mini-comfort handle AX, 27 mm lock inserts, type A

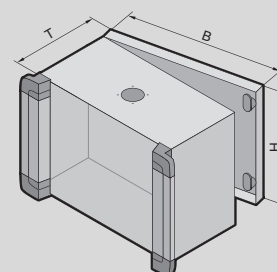

Approvals:

- UL
- cUL

Width (B) mm	Packs of	650	Page
Height (H) mm		450	
Depth (T) mm		155	
Model No.	1 pc(s).	6321.050	
Weight, approx. kg		18.0	
Cam lock		2	
Accessories			
Mini-comfort handle AX for lock inserts or profile half-cylinders	1 pc(s).	2537.100	66
Mini-comfort handle AX for padlock and lock inserts or profile half-cylinders	1 pc(s).	2537.300	66
Lock inserts		see page	67

AX. KX. SYSTEM PERFECTION.

LED system light



ENCLOSURES

POWER DISTRIBUTION

CLIMATE CONTROL

IT INFRASTRUCTURE

SOFTWARE & SERVICES



FRIEDHELM LOH GROUP



ACCESORIES AX – MORE **RELIABLE**

Maintaining all relevant approvals when installing type-tested system accessories such as wall mounting brackets and gland plates improves reliability.







UL conformity

The series-standard UL approvals are maintained in full when inserting Rittal accessory components into existing or new enclosure openings.



Interior installation

Custom enclosures can be configured quickly and easily due to the tool-free, height-adjustable mechanically locked fixing of the interior installation rail using integrated locators and thanks to full compatibility with the comprehensive range of system accessories.

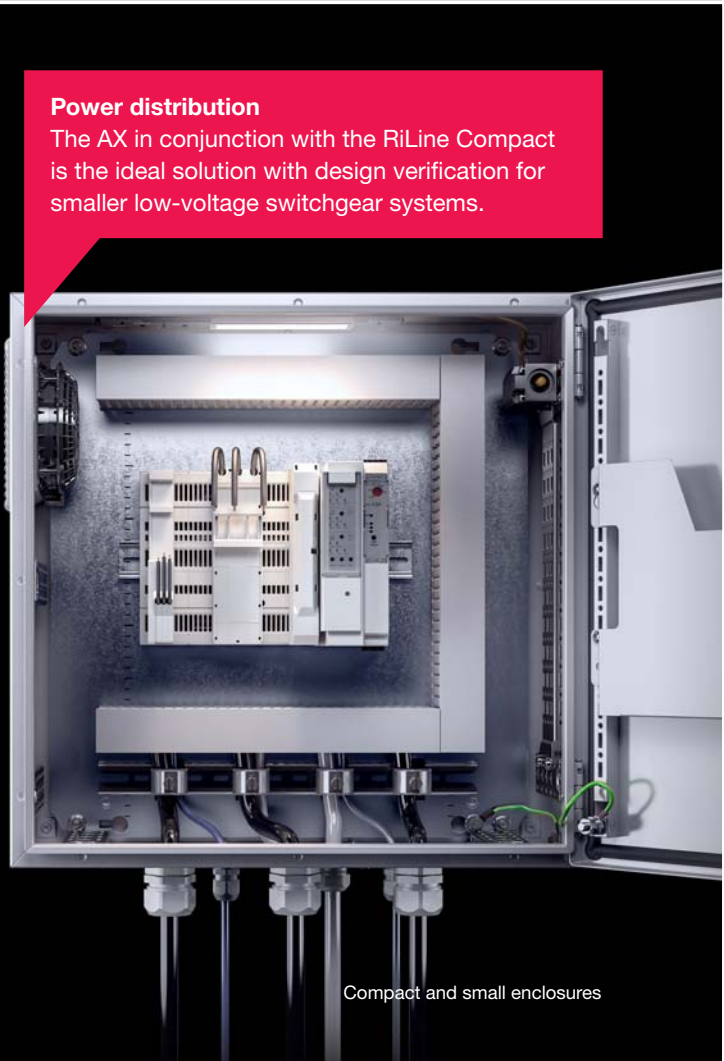

Power distribution

The AX in conjunction with the RiLine Compact is the ideal solution with design verification for smaller low-voltage switchgear systems.



Fast installation

The rail for interior installation ensures that routine tasks such as installing door-operated switches or cable routing can be completed in next to no time without any machining.

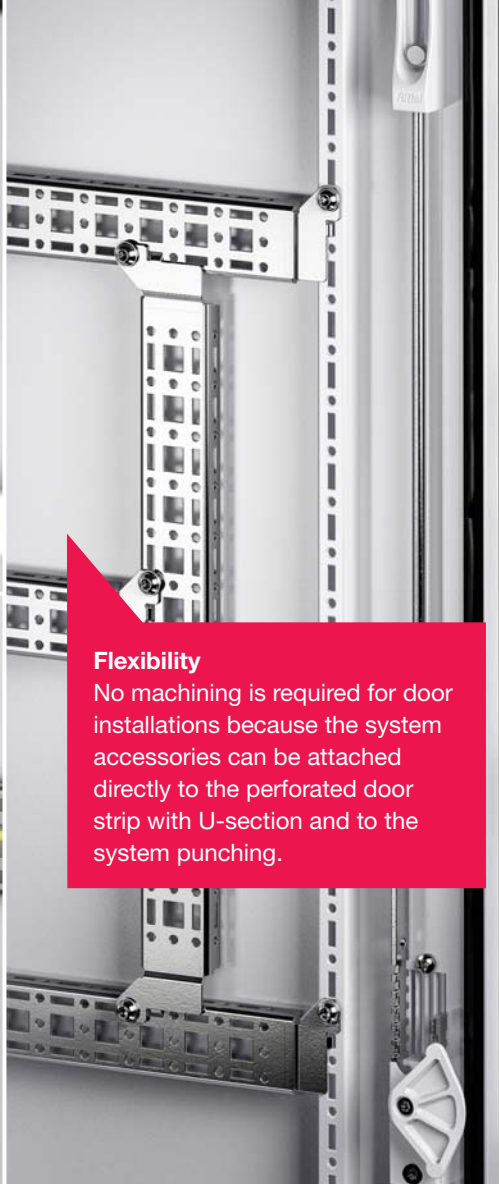

Flexibility

No machining is required for door installations because the system accessories can be attached directly to the perforated door strip with U-section and to the system punching.



Maximum comfort

The comfort handle AX is available for all standard lock inserts, which means it can be incorporated into existing locking systems.



Ease of assembly

Simple attachment via screwfastening from the outside.



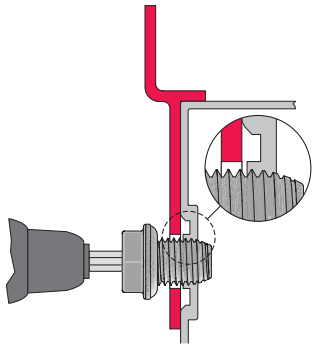

Wall mounting bracket, sheet steel

Square knockouts for attaching wall brackets are provided on the rear of sheet steel enclosures along with an innovative eyelet for direct screw-fastening from the outside using self-tapping screws.



Outdoor housing

The enclosure-within-an-enclosure concept provides effective protection in exceptionally harsh environments. Optimum enclosure ventilation is guaranteed, thanks to a cut-out at the bottom and integrated louvres in the side and base.



Base/plinth system AX

The large opening in the base/plinth corner piece enables it to be screw-fastened to the enclosure directly from the front. The clip-in trim panels allow simple, fast access to the base/plinth for individual use, e.g. as a cable chamber.



Baying

The baying kit can be used to bay enclosures with their own cut-outs quickly in compliance with the designated protection category.



Protective roof

The sloping protective roof reliably protects the enclosure from standing moisture and other soiling from above. It can be attached to the enclosure without any machining.



Pole clamp

The universal pole clamp makes it very easy to fasten enclosures to round or square poles without any machining.



Eyebolts

Eyebolts for transportation can easily be fitted using the holes provided as standard on larger enclosures. Reinforcement plates ensure safe transportation – even when heavy equipment is installed in enclosures.





Door variants

With appropriately dimensioned enclosures, both the viewing window and the operating panel can be used as a door variant. Enclosures can thus be used as a command panel and/or provide a clear view of the components inside.



Door installation

The perforated door strip with integrated 25 mm system punching enables fully customised configuration with wiring plan pockets so that all important documents are always to hand. Punched sections with mounting flanges make it very easy to use doors as additional mounting surfaces.



Door installation

180° hinges and a door stay make it possible to work unimpeded in the enclosure. There is no chance of the door unintentionally slamming shut and no obstruction if space is tight.





Locking system

The comfort handle is available for enclosures with locking rods and cam locks, with all standard versions and lock inserts. Up to six padlocks may be attached to the multiple lock, making it very straightforward to have individual access rights for different groups of people.



Interior installation



Punched sections with mounting flanges, 14 x 39 mm

In conjunction with rails for interior installation or perforated door strips, 14 x 39 mm punched sections with mounting flanges create completely new possibilities in interior installation.



Earth straps

Pre-assembled earth straps of the ideal length are available in all standard cross-sections for reliable earthing. This saves a great deal of time during installation.



ISV installation kit

ISV installation kits make light work of preparing standard AX enclosures for installation using ISV installation modules.



Pressure relief stopper

The sealing membrane in the pressure relief stopper prevents pressure differences as a result of changing climate conditions. This puts a stop to condensation and the resulting corrosion problems.

Rail for interior installation

The rail for interior installation instantly creates an additional mounting surface or the basis for full rail installation in a 25 mm pitch pattern. No machining whatsoever is required and the integrated locators in the enclosure ensure a secure hold – even under dynamic loads.

Mounting bracket

This versatile bracket is used to attach LED system lights in the roof section or on the side of the enclosure in a 25 mm pitch pattern without any machining whatsoever.

Fan-and-filter unit

Rittal fan-and-filter units are the ideal choice for preventing hot spots in the enclosure. When they are used, even UL approvals are maintained in full.



Condensate discharge

The condensate discharge reliably removes any unavoidable condensation that occurs inside the enclosure. The integrated labyrinth seal protects the enclosure against splashes. No machining is required for installation in the case of sheet steel enclosures.



Cable entry



Cable routing
The cable conduit and cable conduit holder ensure flexible and reliable cable routing between door and enclosure.

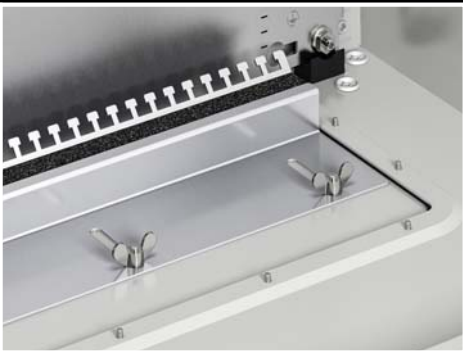
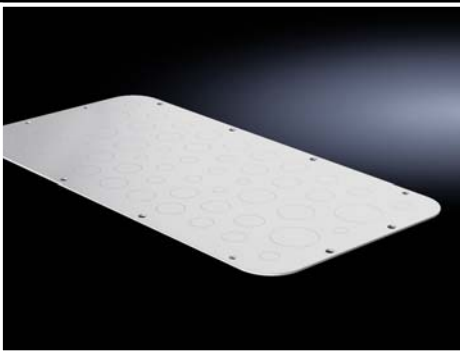

Connector gland, small
Whatever the surface, this component makes light work of introducing pre-assembled cables. Installation is possible up to a material thickness of 4 mm. Cables can be securely fastened to the integrated strain relief component using cable ties.



Modular cable entry

The modular plastic gland plate and the modular sealing frame enable a completely flexible cable entry, even with pre-assembled cables. The seal inserts can be adapted individually to the required cable cross-sections. The modular cable entry is available in the form of a gland plate and for installation on any desired surface.

Rail for interior installation

This can also be used for cable routing or for assemblies such as terminal strips.

Gland plates

Rittal offers the perfect gland plate for every purpose – from plastic gland plates with membranes for rapid cable insertion and metal gland plates with metric knockouts for easy assembly of cable glands to gland plates with cable clamp strips for tasks such as inserting pre-assembled cables.

Cable glands

Depending on the application in question, cable glands are available in brass with nickel plating, in polyamide or as an EMC version. Integrated clamping membranes ensure reliable tightening and strain relief to protect the cables.



System accessories AX

Base/plinth system AX

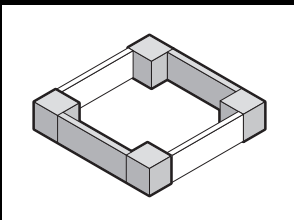
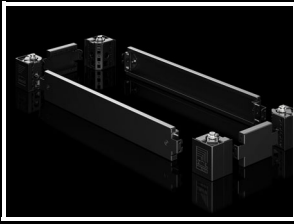

Modular base/plinth diversity

The new, innovative base/plinth system AX offers an unprecedented diversity of functions and applications.

The base/plinth system AX comprises the following components:

- Base/plinth corner pieces with base/plinth trim panels, front and rear
- Base/plinth trim panels, sides

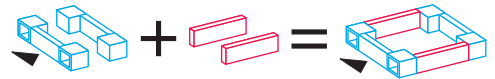

One Model No. for the **base/plinth corner pieces with base/plinth trim panels, front and rear**

One Model No. for the **base/plinth trim panels, side**

One complete **base/plinth AX**

Base/plinth	Basic form	Cable entry options			Stabilisation of bayed base/plinths	
100 mm						
200 mm						

Base/plinth corner pieces with base/plinth trim panels, front and rear

Sheet steel

Base/plinth corner pieces with large opening for optimum access to the screw-fastening point, may be concealed with a plastic corner cover.

Material:

- Base/plinth corner piece: Sheet steel
- Base/plinth trim panel front/rear: Sheet steel
- Corner cover: Plastic

Colour:

- RAL 9005

100 mm high supply includes:

- 4 base/plinth corner pieces, 100 mm high
- 4 corner covers
- 2 base/plinth trim panels, front/rear, 100 mm high
- Assembly parts

200 mm high supply includes:

- 4 base/plinth corner pieces, 200 mm high
- 4 corner covers
- 1 base/plinth trim panel, front/rear, 200 mm high
- 2 base/plinth trim panels, front/rear, 100 mm high
- Assembly parts

100 mm high

For enclosure width mm	Model No.
600	2820.061
800	2820.081
1000	2820.101
1200	2820.121

200 mm high

For enclosure width mm	Model No.
600	2820.062
800	2820.082
1000	2820.102
1200	2820.122



Also required:

- Side base/plinth trim panels, to finish off a base/plinth unit at the end, see page 61



Accessories:

- Base mounting plate, see page 61

System accessories AX

Base/plinth system AX

Base/plinth trim panels, sides

Sheet steel

To finish off a base/plinth unit at the sides and for additional stability or interior configuration of bayed base/plinths. One 200 mm high or two 100 mm high trim panels may optionally be fitted on 200 mm high base/plinths.

Material:

- Sheet steel

Colour:

- RAL 9005

Supply includes:

- 2 base/plinth trim panels
- Assembly parts

100 mm high

For enclosure depth mm	Model No.
300	2820.310
400	2820.410

200 mm high

For enclosure depth mm	Model No.
300	2820.320
400	2820.420

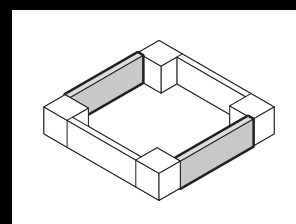

Base mounting plate

For attaching the base/plinth to the floor.
For assembly screws up to 12 mm Ø.

Material:

- Sheet steel

Surface finish:

- Zinc-plated

Packs of	Model No.
10 pc(s).	2817.000



System accessories AX

Base/Baying



Pressure relief stopper

Especially when enclosures are exposed to changing climatic conditions, pressure differences may cause condensation to form in sealed enclosures. The integral sealing membrane in the pressure relief stopper largely prevents such pressure differences and hence eliminates condensation; additionally, it also prevents the ingress of moisture from the outside. Installed in vertical surfaces to protect against dirt.

Technical specifications:

- Air permeability up to 120 litres/hour with a pressure difference of 70 mbar
- Connection thread M12 x 1.5
- For fitting in wall thicknesses up to 4 mm

Packs of	Model No.
5 pc(s).	2459.500

Material:

- Polyamide

Colour:

- Similar to RAL 9005

Protection category IP to IEC 60 529:

- IP X8

Protection category IP to DIN 40 040-9:

- IP 69K

Supply includes:

- Lock nut



Condensate discharge

For reliable condensate discharge from the inside and protection against splashed water from the outside (labyrinth effect). A hole diameter of 16 mm is required (with AX sheet steel, the holes are already provided in the base).

Material:

- Polyamide

Colour:

- Similar to RAL 7035

Protection category:

- Protection from splashed water, when correctly installed at the bottom

Packs of	Model No.
6 pc(s).	2459.000

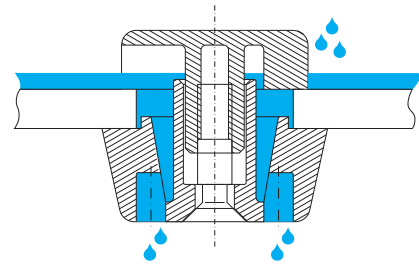

Baying kit

for AX, KX

For baying AX/KX enclosures. The additional cut-outs are to be provided by the customer.

Special screws and nuts

- For fast, simple assembly without thread-tapping
- Compression of the seal is limited to a predefined level, to ensure a long-lasting, permanent seal between enclosures

Seal, self-adhesive

- Comprised of bayable sealing elements and corner pieces, for individual adaptation to various enclosure sizes

One pack is sufficient for a baying point up to H x D = 800 x 350 mm.

Packs of	Model No.
1 pc(s).	1199.100

Supply includes:

- Special screws and nuts
- Sealing elements, self-adhesive



System accessories AX

Viewing window/operating panel

Viewing window

For mounting on

- AX enclosures instead of the door
- Surfaces

Max. installation depth: (depth -4 mm)

Visible area: (width -60 mm) x (height -60 mm)

Material:

- Frame: Aluminium, natural anodised.
- Glazed panel: Acrylic

Protection category IP to IEC 60 529:

- IP 54

Supply includes:

- Plastic handle with lock insert no. 3524 E

Depth 36 mm

For use as door variant with	Width mm	Height mm	Model No.
1050.000, 1350.000, 1007.000, 1013.000	497	497	2733.010
1039.000, 1339.000, 1009.000	597	377	2730.010
1010.000, 1054.000, 1060.000, 1360.000	597	597	2731.010
1012.000, 1076.000, 1376.000	597	757	2732.010

Depth 62 mm

For use as door variant with	Width mm	Height mm	Model No.
1050.000, 1350.000, 1007.000	497	497	2763.010
1039.000, 1339.000, 1009.000	597	377	2760.010
1010.000, 1054.000, 1060.000, 1360.000	597	597	2761.010
1012.000, 1076.000, 1376.000	597	757	2762.010



Horizontally hinged FT stay

For external mounting on surfaces. A gas-pressurised spring holds the viewing window securely open (top or side). When the viewing window is closed, the gas pressurised spring disappears into the frame section.

Packs of	Model No.
1 pc(s).	2772.000



Operating panel

For mounting on

- AX enclosures instead of the door
- Surfaces

Frame construction with a 3 mm aluminium plate secured from the inside.

Material:

- Aluminium, natural anodised

Protection category IP to IEC 60 529:

- IP 54

Supply includes:

- Aluminium frame
- Display panel
- Hinges
- Brackets

For use as door variant for AX	Width mm	Height mm	Depth mm	Model No.
1004.000 1011.000 1031.000	377	297	36	2741.010
1006.000 1303.000 1380.000	377	377	36	2742.010
1008.000 1038.000 1338.000	377	597	36	2743.010
1007.000 1013.000 1050.000 1350.000	497	497	36	2745.010
1009.000 1039.000 1339.000	597	377	36	2744.010
1010.000 1060.000 1304.000 1360.000	597	597	36	2746.010
For surfaces	197	297	36	2740.010

Area available for population:
(width - 70 mm) x (height - 70 mm)

Dimensions of aluminium plate:
(width - 54 mm) x (height - 54 mm)



Accessories:

- Cam lock 2749.100, see page 63

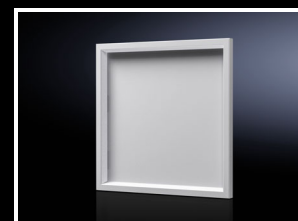

System accessories AX

Viewing window/operating panel



Viewing window

for operating panel

For the protection of display and control components.

With a build height of max. 35 mm.

Material:

- Frame: Aluminium, natural anodised.
- Glazed panel: Smoked acrylic

Supply includes:

- Lock insert no. 3524 E

For display panel	Model No.
2741.010	2791.000
2742.010	2792.000



Cam lock

for operating panel

May be retrofitted to the operating area or enclosure wall of operating panels. Standard double-bit insert may be exchanged for lock inserts, type C.

Packs of	Model No.
1 pc(s).	2749.100



Accessories:

- Lock inserts, type C, see Catalogue 35, page 680

Comfort handle AX

for compact enclosures AX with 3-point lock system

The unlatched handle folds out forwards, and swivels to open the lock. Prepared for the installation of lock inserts or for the installation of standard commercially available 40 or 45 mm profile half-cylinders, as well as lock and push-button inserts.

Other variants prepared for ASSA, oval profile half-cylinder up to a maximum overall length of 26.9 mm and KESO/KABA profile half-cylinder up to a maximum overall length of 42.5 mm and a Ø of 22 mm.

					
	For lock inserts or profile half-cylinders	With security lock insert E1 ¹⁾	For padlocks and lock inserts or profile half-cylinders	Prepared for ASSA lock system	Prepared for KESO/KABA lock system
	Model No.				
Die-cast zinc RAL 7035	2435.100	2435.200	2435.400	2435.500	2435.600
Lock inserts, type A					
7 mm square	2460.000	–	2460.000	–	–
8 mm square	2461.000	–	2461.000	–	–
7 mm triangular	2462.000	–	2462.000	–	–
8 mm triangular	2463.000	–	2463.000	–	–
Screwdriver	2464.000	–	2464.000	–	–
Daimler insert	2465.000	–	2465.000	–	–
3 mm double-bit	2466.000	–	2466.000	–	–
Fiat	2307.000	–	2307.000	–	–
6.5 mm triangular	2460.650	–	2460.650	–	–
Lock and push-button inserts					
Lock insert, lock no. 3524 E ¹⁾	2467.000	–	2467.000	–	–
Push-button insert	2468.000	–	2468.000	–	–
Push-button and lock insert ¹⁾	2469.000 ²⁾	–	2469.000 ²⁾	–	–
Profile half-cylinders					
to DIN 18 252 ³⁾	9785.040 ⁵⁾	–	9785.040 ⁵⁾	–	–
	9785.042 ⁴⁾	–	9785.042 ⁴⁾	–	–

¹⁾ With two keys

²⁾ Lock no. 2123; no other lock is possible

³⁾ With 3 keys for each lock insert

⁴⁾ Packs of two, simultaneous locking within the same pack, no simultaneous locking for different packs

⁵⁾ Different closures



System accessories AX

Lock system





Mini-comfort handle AX

for AX/AX IT with cam lock, KX with cam lock

The lock is opened by swivelling the unlocked handle. Prepared for the installation of lock inserts or for the installation of standard commercially available 40 or 45 mm profile half-cylinders, as well as lock and push-button inserts.

Other variants prepared for ASSA oval profile half-cylinder up to a maximum overall length of 26.9 mm and KESO/KABA profile half-cylinder up to a maximum overall length of 42.5 mm and a Ø of 22 mm.



				
	For lock inserts or profile half-cylinders	For padlocks and lock inserts or profile half-cylinders	Prepared for ASSA	Prepared for KESO/KABA
	Model No.			
Die-cast zinc RAL 7035	2537.100	2537.300	2537.400	2537.500
Lock inserts, type A				
7 mm square	2460.000	2460.000	-	-
8 mm square	2461.000	2461.000	-	-
7 mm triangular	2462.000	2462.000	-	-
8 mm triangular	2463.000	2463.000	-	-
Screwdriver	2464.000	2464.000	-	-
Daimler insert	2465.000	2465.000	-	-
3 mm double-bit	2466.000	2466.000	-	-
Fiat	2307.000	2307.000	-	-
6.5 mm triangular	2460.650	2460.650	-	-
Lock and push-button inserts				
Lock insert, lock no. 3524 E ¹⁾	2467.000	2467.000	-	-
Push-button insert	2468.000	2468.000	-	-
Push-button and lock insert ¹⁾	2469.000 ²⁾	2469.000 ²⁾	-	-
Profile half-cylinders				
to DIN 18 252 ³⁾	9785.040 ⁵⁾	9785.040 ⁵⁾	-	-
	9785.042 ⁴⁾	9785.042 ⁴⁾	-	-

¹⁾ With two keys

²⁾ Lock no. 2123; no other lock is possible

³⁾ With 3 keys for each lock insert

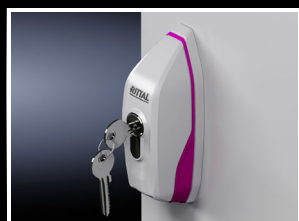

⁴⁾ Packs of two, simultaneous locking within the same pack, no simultaneous locking for different packs

⁵⁾ Different closures



Lock inserts

for installation in comfort handle AX, mini-comfort handle AX

		
	Model No.	
Lock insert, lock no. 3524 E ¹⁾	2467.000	-
Push-button insert	2468.000	-
Push-button and lock insert ¹⁾	2469.000²⁾	-
Profile half-cylinders to DIN 18 252 ³⁾	-	9785.040⁵⁾
	-	9785.042⁴⁾

¹⁾ With two keys

²⁾ Lock no. 2123; no other lock is possible

³⁾ With 3 keys for each lock insert

⁴⁾ Packs of two, simultaneous locking within the same pack, no simultaneous locking for different packs

⁵⁾ Different closures

System accessories AX

Lock system

Lock inserts

For

- AX with cam lock
- AX with 3-point lock system
- Comfort handle AX
- Mini-comfort handle AX

Material:

- Die-cast zinc

Type A, length 27 mm	Model No.
7 mm square	2460.000
8 mm square	2461.000
7 mm triangular	2462.000
8 mm triangular	2463.000
Screwdriver	2464.000
Daimler insert	2465.000
3 mm double-bit	2466.000
Fiat	2307.000
6.5 mm triangular	2460.650

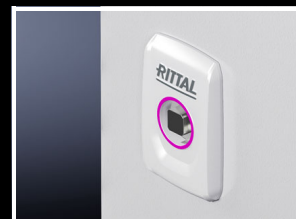

Multiple lock

for 6 padlocks

The ideal solution in cases where several people need individual access for maintenance and repair purposes.

Material:

- Sheet steel

Surface finish:

- Zinc-plated

Packs of	Model No.
2 pc(s).	2493.500



Lock cover

Prepared for lead seal

For retrospective mounting on all compact enclosures AX, sheet steel, with cam lock.

Material:

- Polyamide

Colour:

- RAL 7035

Packs of	Model No.
2 pc(s).	2476.100



System accessories AX

Lock system



Enclosure key

For lock inserts. Enclosure, case and lock systems are supplied as standard with matching keys.

	Model No.			
	-	-	2549.000	2549.500 ²⁾
Double-bit no. 5	2531.000	-		
Security lock no. 3524 E	-	2532.000 ¹⁾	-	-
7 mm triangular	2545.000	-	-	
8 mm triangular	2546.000	-		
7 mm square	2547.000	-	-	
8 mm square	2548.000	-		
for Daimler	2521.000	-	-	-
for Fiat	2308.000	-	-	-

¹⁾ Packs of 2

²⁾ With bit adaptor and reversible bit for multi-tooth size 25 and Phillips-head (Ph 2)



180° hinge

To extend the door opening angle to 180°.

Material:

- Die-cast zinc

Supply includes:

- Assembly parts and drilling template

Packs of	Model No.
3 pc(s).	2449.010



Safety lock

Fitted to doors, to protect against contact with live electrical equipment whilst the master switch is ON.

Function:

- Locks the door when the master switch is ON.
- Mains power (voltage) is only enabled whilst the door is closed.
- Monitoring of the lock magnet via an additional closing contact.

Supply includes:

- Lock
- Actuator
- Angle bracket
- Assembly parts

Connection voltage for lock magnet	Model No.
230 V AC 11 VA	2416.000
24 V DC 8 W	2418.000
120 V AC 8 VA	2419.000



Also required:

- Interior installation rail AX 2394.XXX, see page 77 and punched section with mounting flange 14 x 39 mm for installation in the enclosure and door, see page 78



System accessories AX

Door installation

Support strips

for door installation, for AX

For attachment of

- Cable ducts
- Cable conduit holder
- Equipment installed on the door
- Cable clamping and attachment

4.5 mm diameter hole on a 25 mm DIN pitch pattern

Installation options:

- In the AX sheet steel enclosure door with cam lock

Material:

- Sheet steel

Surface finish:

- Zinc-plated

Supply includes:

- Assembly parts

For door width mm	Length mm	Packs of	Model No.
380	320	20 pc(s).	4599.100
400	340	20 pc(s).	4694.000
500	440	20 pc(s).	4695.000
600	540	20 pc(s).	4696.000
760	700	20 pc(s).	4599.200
800	740	20 pc(s).	4697.000

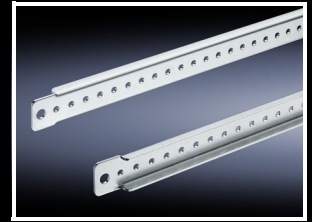

Accessories:

- Screws and self-tapping screws M5, see page 82



Punched section with mounting flange, 14 x 39 mm

for door installation, for AX

For the attachment of

- Cable ducts
- Cable conduit holder
- Equipment installed on the door, etc.

Installation options:

- In the AX sheet steel, in the enclosure door with 3-point lock system in the lockable door

Material:

- Sheet steel

Surface finish:

- Zinc-plated

Supply includes:

- Assembly parts

For door width mm	Distance between attachment points mm	Packs of	Model No.
600	475	4 pc(s).	8619.720
800	675	4 pc(s).	8619.730
1000	375	4 pc(s).	8619.710
1200	475	4 pc(s).	8619.720



Accessories:

- Screws and self-tapping screws M5 for configuring the customer's own components on the punched section with mounting flange, see page 82

Storage box

For fixing to all flat, clean surfaces with double-sided adhesive tape. Secure storage of CDs/DVDs, small parts such as fuses etc.

Capacity:

- Max. 10 CDs/DVDs

Material:

- Polyamide

Packs of	Model No.
1 pc(s).	2446.000



System accessories AX

Door installation

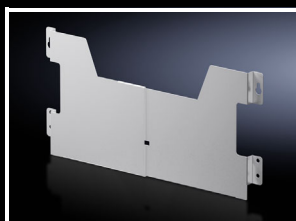

Wiring plan pockets, sheet steel

width-variable, for AX

For fastening to the perforated door strip at any height. Variable and easily adjustable in the width.

Depth: 35 mm

Colour:

– RAL 7035

Supply includes:

– Assembly screws

To fit door width mm	Clearance opening mm		Model No.
	Width	Height	
400, 500	325 – 425	210	2515.200
600	475 – 575	210	2515.300
760, 800	625 – 725	210	2515.400



Plastic wiring plan pockets

For adhering to surfaces.

Material:

– Polystyrene with self-adhesive fastening strips

Colour:

– Similar to RAL 7035

For format	Clearance opening mm			Model No.
	W	H	D	
A3 landscape	438	286	45	2513.000
A4 portrait	228	254	17	2514.000
A5 landscape	228	174	17	2515.000



Wiring plan pockets with transparent pouch

With welded-on transparent pouch and self-adhesive backing.

For format	Model No.
A4	2510.000
A3	2512.000



Door stay AX

To secure the door in the open position. May be fitted without machining the enclosure.

Supply includes:

– Assembly parts

For	Assembly	Packs of	Model No.
AX sheet steel	top	1 pc(s).	2519.020



Also required:

- For installation in AX sheet steel:
Rail for interior installation AX 2394.XXX in the appropriate depth, see page 77

System accessories AX

Roof

Outdoor housing

for AX compact enclosures

- For use outdoors
- For creating an enclosure-within-an-enclosure concept
- Cut-out at the bottom and integrated louvres in the side and base for optimum enclosure ventilation

Material:

- Aluminium AlMg3

Surface finish:

- Powder-coated

Housing W x H x D mm	For AX enclosures W x H x D mm	Packs of	ModelNo.
421 x 550 x 308	300 x 400 x 210	1 pc(s).	9792.055
621 x 650 x 308	500 x 500 x 210	1 pc(s).	9792.065
721 x 750 x 448	600 x 600 x 350	1 pc(s).	9792.075



Also required:

- Wall mounting bracket for AX, sheet steel, see page 73
- Pole clamp, see page 74



Protective roof

for AX

Installation options:

- May also be screw-fastened for dynamic loads

Material:

- Stainless steel 1.4301 (AISI 304)

Surface finish:

- Brushed, grain size 240

Supply includes:

- Assembly parts

For		H mm	Model No.
Enclosure width mm	Enclosure depth T mm		
300	210	37	2361.010
380	210	37	2472.010
500	210	37	2362.010
600	210	37	2473.010
600	350	47	2476.010
760	300	43	2474.010
800	300	43	2475.010
1000	300	43	2363.010



Side view

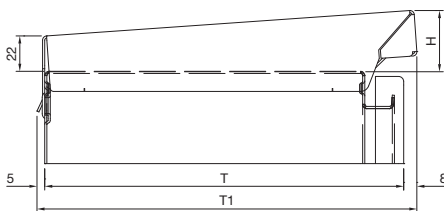

$$T1 = \text{Enclosure depth } T + 13 \text{ mm}$$

Rear view

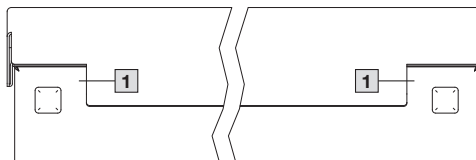

1 Recess for wall mounting bracket

Dust guard trim

for AX, KX

To protect against deposits on the upper edge of the door and between the enclosure and the door/cover. Cut the dust guard trim to length according to the enclosure width. Drill the enclosure and fit the dust guard trim using the adhesive strips and screws.

Material:

- Plastic, UV-resistant

Colour:

- Similar to RAL 7024

Length mm	Model No.
1200	2426.500



System accessories AX

Roof/wall mounting



Eyebolts

for AX

For crane transportation of enclosures, with reinforcement plate to be inserted underneath.

Thread: M12

Supply includes:

- Eyebolts
- Reinforcement plates

Packs of	Model No.
2 pc(s).	2509.010

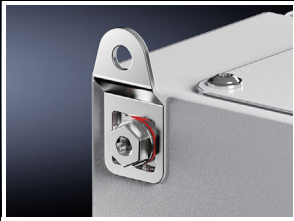
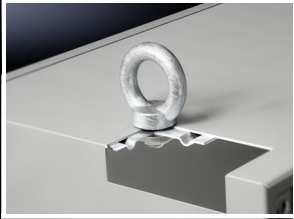

Wall mounting bracket

for AX sheet steel, KX sheet steel, AX IT, EL

For the attachment of sheet steel enclosures.

Benefits:

- Screw-fastened directly from the rear with a self-tapping screw in the enclosure eyelet

Supply includes:

- Assembly parts

Material	Wall distance mm	Packs of	Model No.
Sheet steel, zinc-plated	10	4 pc(s).	1590.010

System accessories AX

Wall mounting

Wall mounting bracket

for AX sheet steel, KX sheet steel, AX IT

Ideal for convenient one-person assembly of wall-mounted enclosures, even in confined spaces.

Benefits:

- Screw-fastened directly from the rear with a self-tapping screw in the enclosure eyelet
- The wall-mounted bracket 2508.020 is equipped with an additional location contour. Simply located onto a pre-fitted screw in the wall
- Different mounting positions allow the wall mounting bracket to be tailored to local conditions on site
- If necessary, the support may be finished with a stylish cover cap
- Additional option of attaching with a nut for dynamic applications

Supply includes:

- Wall mounting bracket
- Cover cap
- Assembly parts

Material	Wall distance mm	Packs of	Model No.
Sheet steel, zinc-plated	20	4 pc(s).	2508.020
	40	4 pc(s).	2503.020

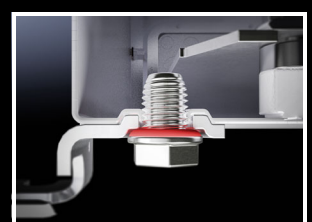
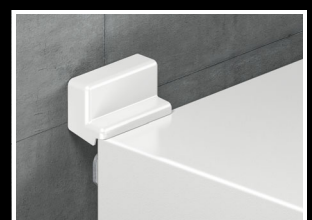
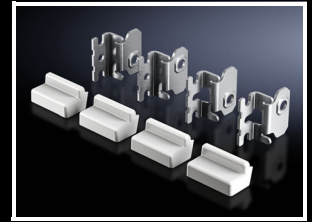

Sample applications

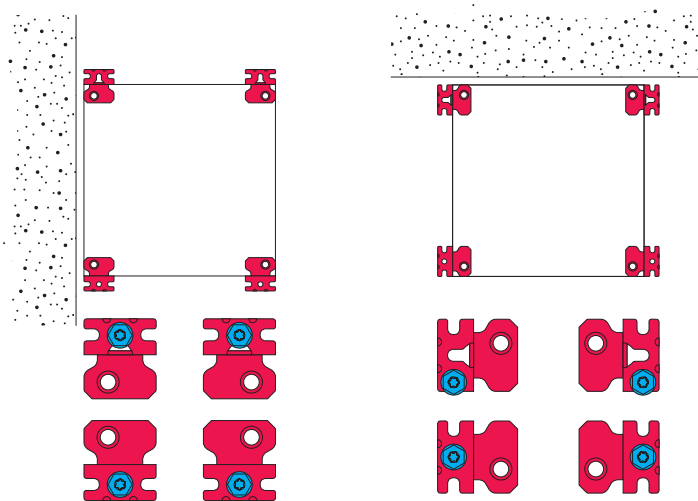

Attachment with self-tapping screw

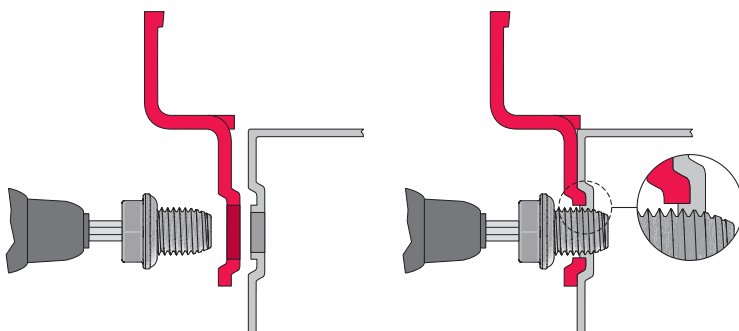

System accessories AX

Wall mounting



Wall angle

for AX, KX, AX IT

For the attachment of sheet steel and stainless steel enclosures.

Supply includes:

- Assembly parts for mounting on the enclosure

Note:

- Additional holes required in the enclosure

Material	Colour	Packs of	Model No.
Sheet steel	RAL 7035	4 pc(s).	2505.510
Stainless steel 1.4301 (AISI 304)	-	4 pc(s).	2583.010

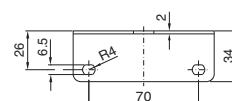
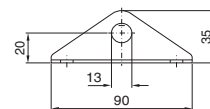

Pole clamp

for AX, KX, AX plastic, AX IT

For reliable, convenient fastening to round or square poles.

For pole diameter / size:

- Ø from 40 to 170 mm
- □ from 50 to 150 mm

Material:

- Mounting angles, clamping section: Sheet steel
- Clamping strap: Stainless steel 1.4301 (AISI 304)

Surface finish:

- Mounting angle, clamping section: Zinc-plated

Supply includes:

- 2 mounting angles, 600 mm long
- 4 clamping sections
- 2 clamping straps
- 4 clamping brackets
- Assembly parts

Packs of	Model No.
2 pc(s).	2584.100

Note:

- The pole clamp cannot be used in conjunction with a protective roof for AX.



System accessories AX

Rail systems

AX configuration examples: Rail for interior installation

1 Rail for interior installation AX		Page
For enclosure depth mm		
	210	2394.210
	250	2394.250
	300	2394.300
	350	2394.350
	400	2394.400

AX configuration examples: Interior installation of the enclosure

For enclosure width/height mm	Installation in the enclosure height				Installation in the enclosure width			
	2 Support strip		3 Punched section with mounting flange, 14 x 39 mm		4 Support strip		5 Punched section with mounting flange, 14 x 39 mm	
	Model No.	Page	Model No.	Page	Model No.	Page	Model No.	Page
300	-	69	-	78	4594.000	69	8619.700	78
380	-		-		-			
400	4594.000		8619.700		4309.000		8619.710	
500	4309.000		8619.710		4596.000		8619.720	
600	4596.000		8619.720		8800.130		8619.760	
700	8800.130		8619.760		-		-	
760	-		8619.790		-		-	
800	4598.000		8619.730		4579.000		8619.740	
1000	4599.000		8619.750		-		-	
1200	-		8619.770		-		-	
1400	-		8619.780		-		-	

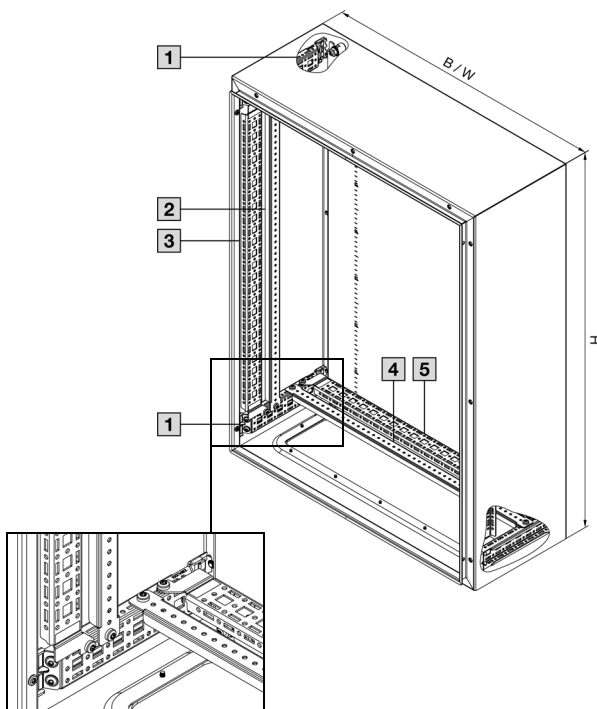

System accessories AX

Rail systems

AX configuration examples: Interior installation with base configuration rail

[6] AX base configuration rail combined with an interior installation rail	Page
Model No.	
2394.100	79

For enclosure width/height mm	Installation in the enclosure height		Installation in the enclosure width					
	[7] Punched section with mounting flange, 23 x 64 mm	[8] Punched section with mounting flange, 23 x 64 mm	[9] Support rail, 48 x 26 mm	[10] Cable clamp rail				
	Model No.	Page	Model No.	Page	Model No.	Page	Model No.	Page
300	8617.100	79	8617.100	79	–	79	–	80
380	–		–		–			
400	8617.110		8617.110		–		8619.400	
500	8617.120		8617.120		–		–	
600	8617.130		8617.130		8617.800		8619.410	
700	–		–		–		–	
760	–		–		–		–	
800	8617.140		8617.140		8617.810		8619.420	
1000	8617.150		8617.150		8617.820		8619.430	
1200	8617.160		8617.160		8617.830		8619.440	
1400	8617.170		–		–		–	

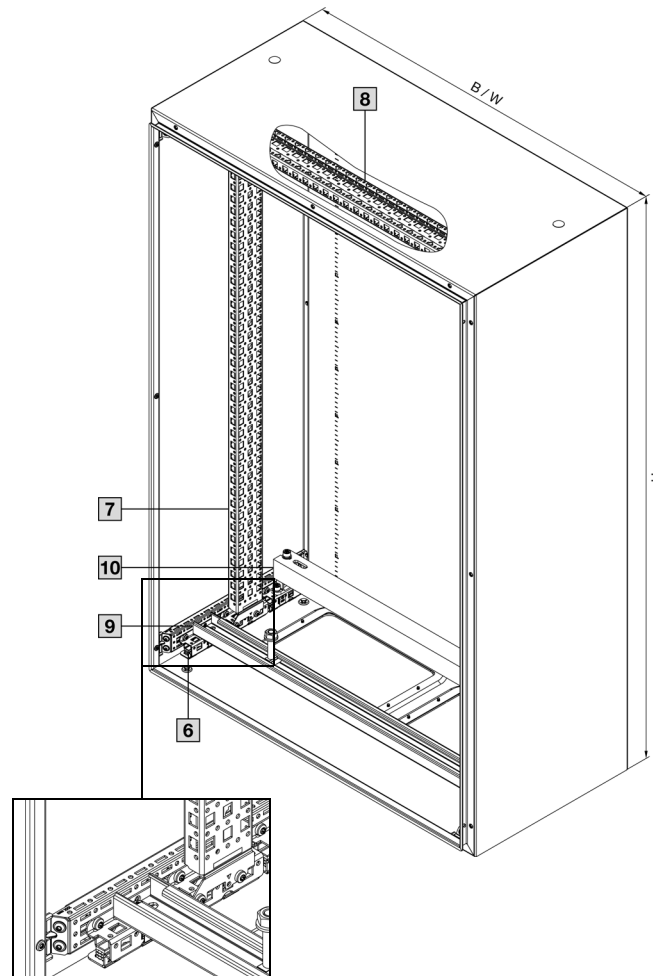

System accessories AX

Rail systems

Rail for interior installation AX

For mounting in the enclosure, no machining required.

Variable with 2 rows of system punchings, creates additional mounting space e.g. for:

- Enclosure lights
- Door-operated switch
- Door stay
- Punched sections with mounting flanges, 14 x 39 mm
- Punched sections with mounting flanges, 23 x 64 mm
- Cable conduit holder
- Cable clamp rails
- Support rails

Benefits:

- Increased load-bearing capacity
- Stable mounting of the rail inside the enclosure
- Including adaptor for door-operated switch
- Compatible with VX25 accessories in conjunction with AX base configuration rail
- Enclosure protection category is retained (no machining required)
- Automatic potential equalisation
- May be retro-fitted even with the mounting plate in situ

Material:

- Sheet steel

Surface finish:

- Zinc-plated

For enclosure depth mm	Packs of	Model No.
210	4 pc(s).	2394.210
250	4 pc(s).	2394.250
300	4 pc(s).	2394.300
350	4 pc(s).	2394.350
400	4 pc(s).	2394.400



Also required:

- For installing the LED system light: Mounting bracket for interior installation, see page 81
- For mounting VX support rails, VX cable clamp rails and VX punched sections with mounting flanges 23 x 64 mm: AX base configuration rail, see page 79.

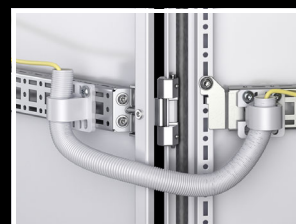
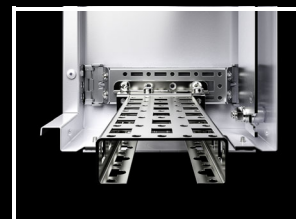

System accessories AX

Rail systems



Punched section with mounting flange, 14 x 39 mm

for AX

Interior installation in the enclosure height and width
Locates securely onto the interior installation rail AX.

For the attachment of

- Cable ducts
- Cable conduit holder

Material:

- Sheet steel

Surface finish:

- Zinc-plated

Supply includes:

- Assembly parts

For enclosure height/width mm	Distance between attachment points mm	Packs of	Model No.	
			Installation in the enclosure height	Installation in the enclosure width
300	175	4 pc(s).	-	8619.700
400	275	4 pc(s).	8619.700	8619.710
500	375	4 pc(s).	8619.710	8619.720
600	475	4 pc(s).	8619.720	8619.760
700	575	4 pc(s).	8619.760	8619.730
760	635	4 pc(s).	8619.790	-
800	675	4 pc(s).	8619.730	8619.740
1000	875	4 pc(s).	8619.750	-
1200	1075	4 pc(s).	8619.770	-
1400	1275	4 pc(s).	8619.780	-



Also required:

- Interior installation rail AX 2394.XXX for configuration in the enclosure height and width, see page 77



Accessories:

- Screws and self-tapping screws M5 for configuring the customer's own components on the punched section with mounting flange, see page 82



Support strips

for AX

For simple interior installation in the enclosure height and width.

Material:

- Sheet steel

Surface finish:

- Zinc-plated

Supply includes:

- Assembly parts

For enclosure height/width mm	Packs of	Model No.	
		Installation in the enclosure height	Installation in the enclosure width
300	20 pc(s).	-	4594.000
400	20 pc(s).	4594.000	4309.000
500	20 pc(s).	4309.000	4596.000
600	20 pc(s).	4596.000	8800.130
700	20 pc(s).	8800.130	4598.000
760	20 pc(s).	-	-
800	20 pc(s).	4598.000	4579.000
1000	20 pc(s).	4599.000	-



Also required:

- Rail for interior installation AX 2394.XXX, see page 77



Accessories:

- Screws, see Catalogue 36, page 1004
- Cable ties 2597.000, see Catalogue 36, page 1061

System accessories AX

Rail systems

Base configuration rail AX

For installation in AX sheet steel in combination with the AX interior installation rail

Length mm	Packs of	Model No.
99	4 pc(s).	2394.100

For the installation of VX accessories such as:

- VX support rail, 48 x 26 mm
- VX cable clamp rail
- VX punched section with mounting flange, 23 x 64 mm

! Also required:

- Rail for interior installation AX 2394.XXX, see page 77

Material:

- Sheet steel

Surface finish:

- Zinc-plated



Punched section with mounting flange, 23 x 64 mm

For variable, individual interior installation. Simply secure to the interior installation rail above the base configuration rail in the AX. System punchings on all four sides. With slots at the top and bottom for cage nuts, for attaching your own components via metric screws.

For enclosure height/width mm	Packs of	Model No.
300	4 pc(s).	8617.100
400	4 pc(s).	8617.110
500	4 pc(s).	8617.120
600	4 pc(s).	8617.130
800	4 pc(s).	8617.140
1000	4 pc(s).	8617.150
1200	4 pc(s).	8617.160
1400	4 pc(s).	8617.170

Installation options:

- In the width and height of the AX in conjunction with the AX interior installation rail and AX base configuration rail

Material:

- Sheet steel

Surface finish:

- Zinc-plated

Supply includes:

- Assembly parts

! Also required:

- For AX: AX interior installation rail 2394.XXX, see page 77 and AX base configuration rail, see page 79

+ Accessories:

- Screws, see page 82
- Cable ties 2597.000, see Catalogue 36, page 1061
- Cage nuts M5 4166.500, M6 4164.500, M8 4165.500, see Catalogue 36, page 1002

Configuration examples, see page 76

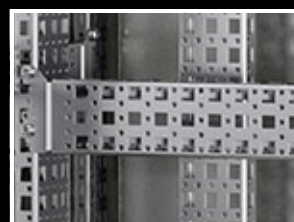
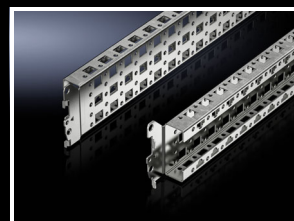

Support rail 48 x 26 mm

For heavy installed equipment such as transformers. T-head screw and slots in the support rail accommodate all mounting dimensions.

For enclosure width mm	Packs of	Model No.
600	2 pc(s).	8617.800
800	2 pc(s).	8617.810
1000	2 pc(s).	8617.820
1200	2 pc(s).	8617.830

Installation options:

- In the width of the AX in conjunction with the AX interior installation rail and AX base configuration rail

Material:

- Sheet steel

Surface finish:

- Zinc-plated

Supply includes:

- Assembly parts

! Also required:

- For AX: AX interior installation rail 2394.XXX, see page 77 and AX base configuration rail, see page 79

+ Accessories:

- Punched section with mounting flange 23 x 64 mm for height-offset installation, see page 79

Configuration examples, see page 76

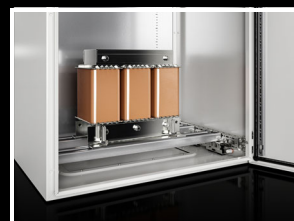
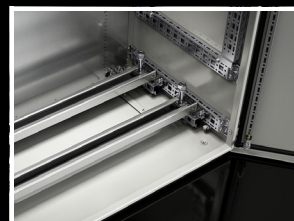

System accessories AX

Rail systems



Cable clamp rail

Right angle section

For strain relief with cable entry. Depth-variable mounting on a 25 mm pitch pattern in the AX in conjunction with the interior installation rail and base configuration rail.

Material:

- Steel

Surface finish:

- Zinc-plated

Supply includes:

- Assembly parts

Enclosure width mm	Packs of	Model No.
400	2 pc(s).	8619.400
600	2 pc(s).	8619.410
800	2 pc(s).	8619.420
1000	2 pc(s).	8619.430
1200	2 pc(s).	8619.440



Also required:

- For AX: AX interior installation rail 2394.XXX, see page 77 and AX base configuration rail, see page 79

Configuration examples, see page 76



Cable clamp

for cable clamp rails

For fastening the cables to the cable clamp rails.

Material:

- Sheet steel

Surface finish:

- Zinc-plated

Supply includes:

- Plastic insert

For cable diameter mm	Packs of	Model No.
6 – 12	25 pc(s).	2350.000
12 – 16	25 pc(s).	2351.000
14 – 18	25 pc(s).	2352.000
18 – 22	25 pc(s).	2353.000
22 – 26	25 pc(s).	2354.000
26 – 30	25 pc(s).	2355.000
30 – 34	25 pc(s).	2356.000
34 – 38	25 pc(s).	2357.000
38 – 42	25 pc(s).	2358.000
42 – 46	25 pc(s).	2359.000
46 – 50	25 pc(s).	2360.000



Support rails TS 35/7.5 and TS 35/15

to EN 60 715 for AX, KX

Length sized to the enclosure width.

For enclosure width mm	Support rails length mm	Design	Packs of	Model No.
150	137	TS 35/7.5	10 pc(s).	2314.000
200	187		10 pc(s).	2315.000
300	287		10 pc(s).	2316.000
400	387		10 pc(s).	2317.000
500	487	TS 35/15	10 pc(s).	2318.000
600	587		10 pc(s).	2319.000

Support rails

to EN 60 715

Standard length: 2 m

Design	Length	Packs of	Model No.
TS 35/15	2 m	6 pc(s).	2313.150
TS 35/7.5	2 m	6 pc(s).	2313.750

System accessories AX

Rail systems/assembly components

Mounting clip

for support rails

For fast, secure attachment of:

- Cable ducts
- Mounting plates
- Mounting angles

on support rail TS 35/7.5 and 35/15 to EN 60 715. Simply pre-assemble the mounting clip on the part to be installed, then snap into position on the support rail.

Packs of	Model No.
30 pc(s).	2309.000



Mounting bracket

Installation options:

- On all enclosures and mounting parts with system punchings on a 25 mm pitch pattern

Material:

- Sheet steel

Surface finish:

- Zinc-plated

Supply includes:

- Assembly screws

Packs of	Model No.
4 pc(s).	4597.000



Accessories:

- Screws, see page 82
- Cable ties 2597.000, see Catalogue 36, page 1061



Mounting bracket

for interior installation

In conjunction with the rail for interior installation, the mounting bracket allows the LED system light to be fitted without machining and without the use of tools.

Material:

- Sheet steel

Surface finish:

- Zinc-plated

Supply includes:

- Assembly parts

Packs of	Model No.
4 pc(s).	6205.100



Also required:

- Rail for interior installation AX 2394.XXX, see page 77

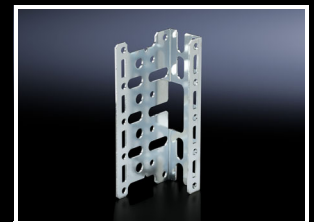

Rail mounting bracket

For individual mounting of rails at a distance from the mounting surface.

Material:

- Sheet steel, zinc-plated

Rail mounting bracket	Packs of	Model No.
Flat	20 pc(s).	2365.000
Inclined	20 pc(s).	2366.000

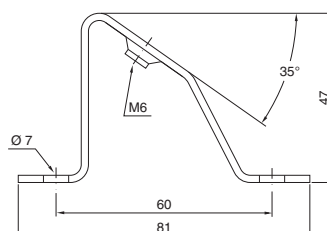
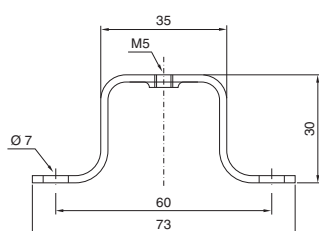

System accessories AX

Assembly components

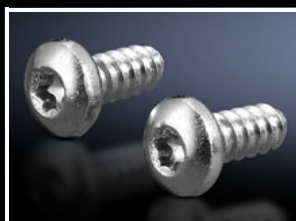

Metal multi-tooth screw

For the round holes \varnothing 4.5 mm in the enclosure section, punched rails and punched sections without mounting flanges.

Multi-tooth drive for optimum transmission of torques, an extended tool life and increased safety and reliability when tightening and loosening screw connections.

Type of screw	Dimensions mm	Packs of	ModelNo.
Metal multi-tooth screws	5.5 x 13	300 pc(s).	2486.600
Metal multi-tooth screws for stainless steel	5 x 13	300 pc(s).	2486.400
Self-tapping screws (hex screws)	M5 x 10	500 pc(s).	2504.000
Self-tapping screws	ST 4.8 x 16	300 pc(s).	2487.000

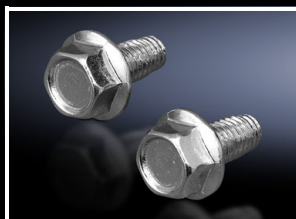

Self-tapping screw

For the round holes \varnothing 4.5 mm in the enclosure section, punched rails and punched sections without mounting flanges.



Self-tapping screw

Mark, drill and tighten in a single operation using electric or pneumatic tools.

For metal thickness: 0.8 – 3 mm
Length: 16 mm
Usable length: 9.5 mm
Width across flats: 8 mm



Isolator cap

for screw head

To isolate screw heads within the cable duct.

Material:

– Plastic

Packs of	Model No.
100 pc(s).	8800.770

System accessories AX

482.6 mm (19") installation system

Swing frame, small

for 600 and 800 mm wide compact enclosures AX

For mounting 482.6 mm (19") equipment.

Material:

– Sheet steel

Surface finish:

– Zinc-plated

Supply includes:

– Cam with double-bit lock insert and parts for attaching to the installation kit

Note:

– The swing frame stay 8619.270 is required to lock the open swing frame.



Accessories:

– 482.6 mm (19") fastener, 1 U, 2090.000

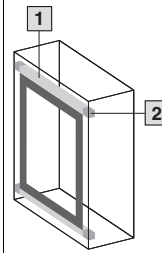

U	From enclosure height mm	Packs of	Model No.
3	380	1 pc(s).	8619.500
6	600	1 pc(s).	8619.510
9	600	1 pc(s).	8619.520
12	760	1 pc(s).	8619.530

Also required:

	For enclosure width mm		
1 Installation kit	600	1 pc(s).	8619.600
	800	1 pc(s).	8619.610
2 Mounting kit AX	600	4 pc(s).	2034.010
	800		

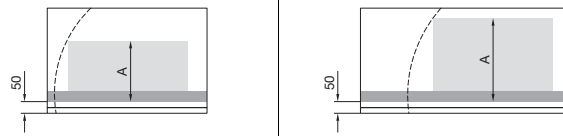

Enclosure dimensions mm		A = max. installation depth mm with internal mounting	
Width	Depth	Centre	Side
600	210	130	–
600	250	170	–
600	350	220	–
600	400	220	–
800	300	210	210
800	400	310	310

Installation kit

for swing frame, small

For mounting the small swing frame in compact enclosures AX.

Load capacity:

– Up to 1500 N

Material:

– Sheet steel

Surface finish:

– Nickel-plated

Supply includes:

– Assembly parts

For enclosure width mm	Packs of	Model No.
600	1 pc(s).	8619.600
800	1 pc(s).	8619.610



Also required:

– For mounting in compact enclosures AX:
Mounting kit AX

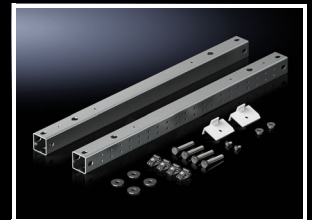

Mounting kit AX

for installation kit for swing frame, small

For mounting the small swing frame in compact enclosures AX.

Supply includes:

– 4 mounting brackets

Note:

– 1 pack is sufficient for mounting one small swing frame

Packs of	Model No.
4 pc(s).	2034.010

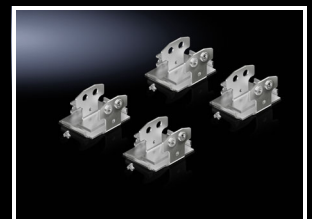

System accessories AX

Earthing

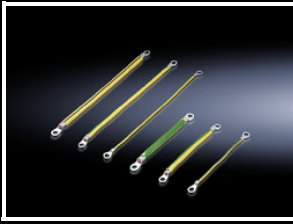

Earth straps

For configuring a reliable earthing connection with perfect contact

- With ring terminals to match the earthing screws
- Length-optimised and ready to install



Also required:

- Assembly parts for earth straps, see Cat. 36, page 1033

For AX enclosures

Connection option			Cross-section mm ²	Length mm	Packs of	Model No.
Door	Enclosure	Mounting plate				
M8	M8	M8	4	170	5 pc(s).	2564.000
			16	170	5 pc(s).	2565.000
			25	170	5 pc(s).	2566.000
			4	300	5 pc(s).	2567.000
			10	300	5 pc(s).	2565.120
			16	300	5 pc(s).	2568.000
			25	300	5 pc(s).	2569.000



System accessories AX

ISV distribution enclosures, installation kits

ISV installation kit

for AX

For mounting ISV installation modules in the enclosure.

Material:

- Assembly kit: sheet steel, zinc-plated
- Support rail: sheet steel, zinc-plated
- Contact hazard protection: sheet steel, spray-finished

Supply includes:

- Assembly kit
- Support rails
- Contact hazard protection
- Assembly parts



Also required:

- Mounting angles ISV, see page 85

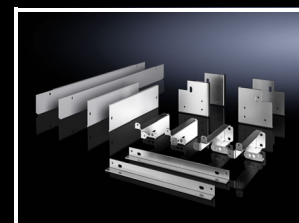

For enclosure width mm	For enclosure height mm	For enclosure depth mm	Width units (WU) @ 250 mm	Height units (U) @ 150 mm	To fit Model No.	Packs of	Model No.
380	600	210	1	3	1008.X00/ 1038.X00	1 pc(s).	9666.801
500	700	250	1	4	1057.X00	1 pc(s).	9666.811
600	760	210	2	4	1012.X00/ 1076.X00	1 pc(s).	9666.821
600	1000	250	2	6	1090.X00	1 pc(s).	9666.831
600	1200	300	2	7	1260.X00	1 pc(s).	9666.841
1000	1200	300	3	7	1019.X00/ 1213.X00/ 1305.X00	1 pc(s).	9666.851

Mounting angles ISV

for AX

For vertical sub-division of the support frame in the enclosure.

Material:

- Sheet steel

Surface finish:

- Zinc-plated

Height unit		Packs of	Model No.
U	mm		
3	450	2 pc(s).	9666.753
4	600	2 pc(s).	9666.754
6	900	2 pc(s).	9666.756
7	1050	2 pc(s).	9666.757

1 U $\hat{=}$ 150 mm

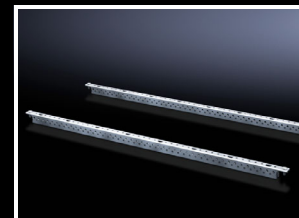

System accessories AX

Cable gland



Plastic cable gland, modular and sealing frame, modular

The modular plastic cable gland and the modular sealing frame offer extensive flexibility with the entry of assembled and unassembled cables, with or without connectors. Depending on the cable cross-section, suitable modules may be selected to retain the high protection category of IP 66 after cable entry.

The gland plate design also supports mixed use with standard cable glands and inlays with seal inserts. In this way, cables prefitted with connectors may be safely inserted into the enclosure retrospectively. Seven different gland plate sizes are available. The sealing frame design may be used on any sufficiently large surface.

Plastic gland plate, modular for AX

- 1 Rectangular cut-outs for inlays and seal inserts, see page 87
- 2 Metric knockouts for cable glands, see page 93
- 3 Plastic gland plates, modular, see page 90

Sealing frame, modular for AX, KX

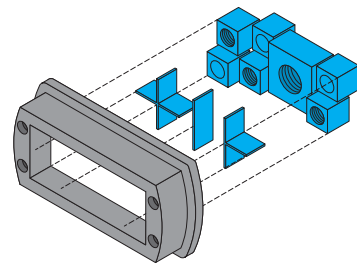
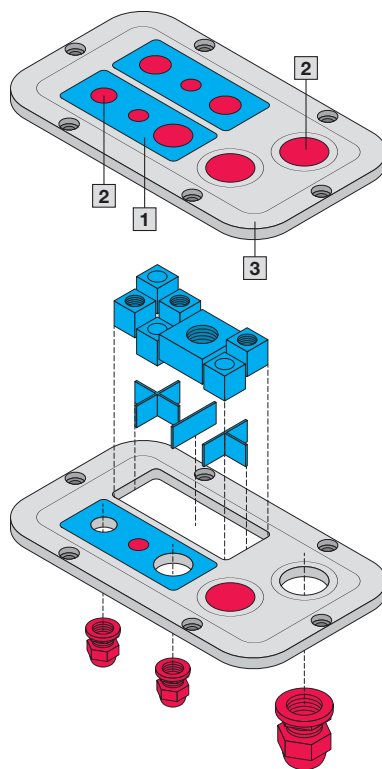

System accessories AX

Cable gland

Sealing frame, modular

For universal use on all surfaces and walls, for inserting pre-assembled cables with connectors. Can also be mounted onto 24-pole or 16-pole connector cut-outs.

Material:

– Plastic

Colour:

– Black

Protection category IP to IEC 60 529:

– IP 66

Supply includes:

– Sealing frame
– Locking frame

Number of small seal inserts	For cut-out mm	Model No.
10	113.5 x 46 (24-pole)	2583.100
8	91 x 46 (16-pole)	2583.080



Also required:

- Inlay for plastic gland plates, modular and sealing frame, modular, see page 87
- Seal inserts for cable gland plates, modular and sealing frame, modular, see page 87



Inlay

for plastic gland plate, modular and sealing frame, modular

Individual inserts to subdivide the cut-outs in the modular plastic gland plate and the modular sealing frame.

Material:

– Plastic

Colour:

– Black

Version	Packs of	Model No.
1 slot	5 pc(s).	2582.100
2 slots	5 pc(s).	2582.200
4 slots	5 pc(s).	2582.400
6 slots	5 pc(s).	2582.600

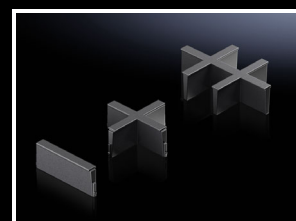

Seal inserts

for plastic gland plate, modular and sealing frame, modular

In conjunction with the inlays, the seal inserts allow individual cable entry, even with preassembled cables.

Material:

– Plastic

Colour:

– RAL 7035



Accessories:

- When using as a gland plate, modular: Locking clip for seal inserts, see page 88

Seal inserts, small

For cable diameter	Packs of	Model No.
Solid	10 pc(s).	2580.000
3 mm	10 pc(s).	2580.003
4 mm	10 pc(s).	2580.004
5 mm	10 pc(s).	2580.005
6 mm	10 pc(s).	2580.006
7 mm	10 pc(s).	2580.007
8 mm	10 pc(s).	2580.008
9 mm	10 pc(s).	2580.009
10 mm	10 pc(s).	2580.010
11 mm	10 pc(s).	2580.011
12 mm	10 pc(s).	2580.012
13 mm	10 pc(s).	2580.013
14 mm	10 pc(s).	2580.014

Seal inserts, large

For cable diameter	Packs of	Model No.
Solid	5 pc(s).	2580.100
15 mm	5 pc(s).	2580.115
16 mm	5 pc(s).	2580.116
17 mm	5 pc(s).	2580.117
18 mm	5 pc(s).	2580.118
19 mm	5 pc(s).	2580.119
20 mm	5 pc(s).	2580.120
21 mm	5 pc(s).	2580.121
22 mm	5 pc(s).	2580.122
23 mm	5 pc(s).	2580.123
24 mm	5 pc(s).	2580.124
25 mm	5 pc(s).	2580.125

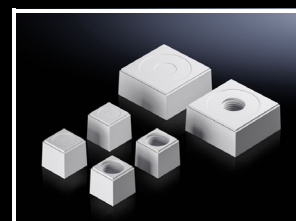

System accessories AX

Cable gland

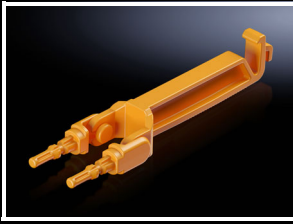

Locking clip for seal inserts

The locking clips in conjunction with the modular plastic gland plate hold the seal inserts so they are not accidentally pushed into the enclosure.

Material:

- Plastic

Packs of	Model No.
10 pc(s).	2583.120



System accessories AX

Gland plates

Plastic gland plate, modular with metric knockouts, for AX

Simply pierce the plastic knockouts, and pull through the cable. Additional rectangular cut-outs and reinforcement frame allow the inlays and seal inserts to be installed directly.

Temperature range:

– Suitable for use from -40 °C...+80 °C

Material:

– Plastic to UL 94-V0

Colour:

– RAL 7035

Protection category IP to IEC 60 529:

– IP 66 if installed correctly

Note:

– The applicable size may be taken from the relevant product ordering page



Accessories:

- Inlay, see page 87
- Seal inserts, see page 87
- Cable glands, see page 93

Model No.	2561.200	2562.200	2563.200	2564.200	2565.200	2566.200	2567.200
Packs of	1 pc(s).	1 pc(s).	1 pc(s).	1 pc(s).	1 pc(s).	1 pc(s).	1 pc(s).
Gland plate	Size 1	Size 2	Size 3	Size 4	Size 5	Size 6	Size 7
Dimensions W x D mm	256 x 149	339 x 149	447 x 149	534 x 149	301 x 221	401 x 221	436 x 221
	Diameter mm		Number of cable entries				
	M12	2	3	4	5	4	4
	M16	1	2	3	4	4	6
	M20	2	3	5	6	4	5
	M25	1	3	3	5	3	4
	M32	2	2	1	1	1	1
	M40	–	–	1	1	1	1
	M50	–	–	–	–	–	1
Rectangular cut-outs	2	3	4	6	5	6	6

Size 1

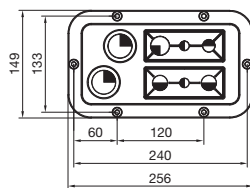

Size 2

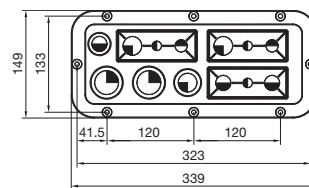

Size 3

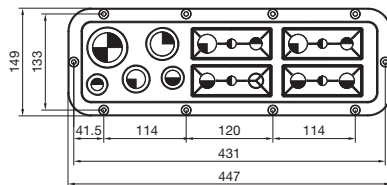

Size 5

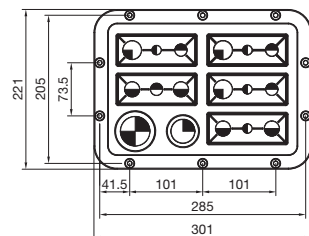

Size 4

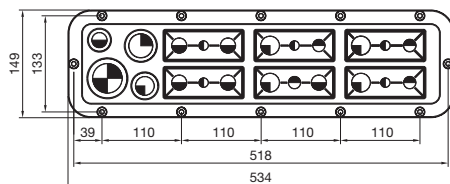

Size 6

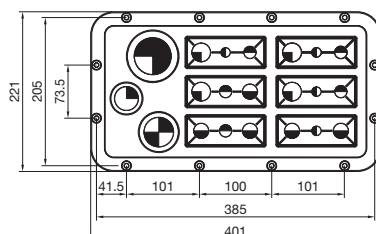

Size 7

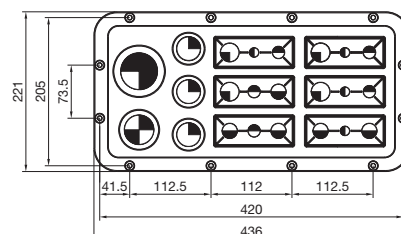

System accessories AX

Gland plates



Plastic gland plates

with membranes, for AX

Simply pierce the plastic with a sharp object, and pull through the cable.

Material:

– Plastic to UL 94-V0

Colour:

– Similar to RAL 7035

Protection category IP to IEC 60 529:

– IP 66 if installed correctly

Note:

– The applicable size may be taken from the relevant product ordering page

Model No.	2561.300	2562.300	2563.300	2564.300	2565.300	2566.300	2567.300
Packs of	1 pc(s).	1 pc(s).	1 pc(s).	1 pc(s).	1 pc(s).	1 pc(s).	1 pc(s).
Gland plate	Size 1	Size 2	Size 3	Size 4	Size 5	Size 6	Size 7
Dimensions W x D mm	256 x 149	339 x 149	447 x 149	534 x 149	301 x 221	401 x 221	436 x 221
	Diameter mm		Number of cable entries				
●	5 – 11	15	24	36	28	30	30
◐	10 – 15	22	44	46	48	40	50
◑	15 – 25	8	6	8	8	5	8
◒	19 – 34	4	2	2	2	2	2
◓	26 – 35	–	–	4	2	–	2
◔	26 – 54	1	2	2	2	2	2
○	50 – 110	–	–	–	1	1	1

Size 1

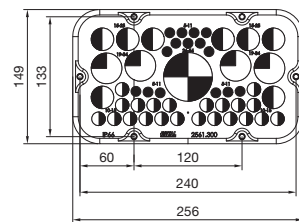

Size 2

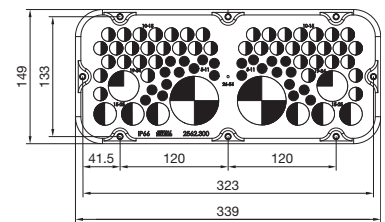

Size 3

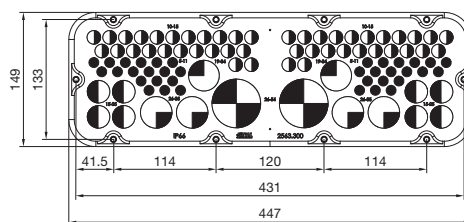

Size 5

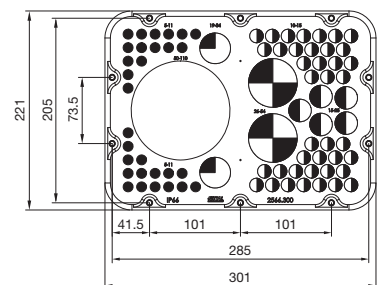

Size 4

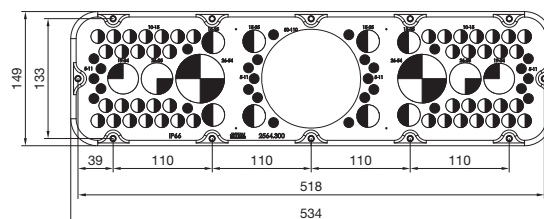

Size 6

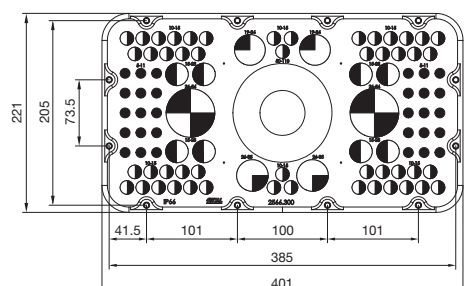

Size 7

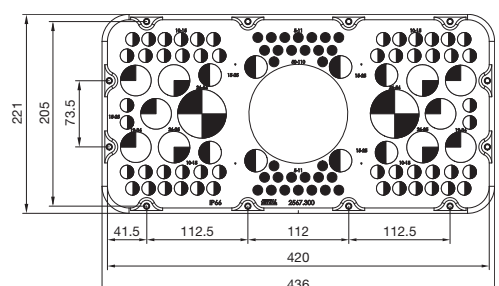

System accessories AX

Gland plates

Metal gland plate

with metric knockouts, for AX

Simply knock out the holes for the cable glands using a screwdriver.

Material:

– Sheet steel

Colour:

– RAL 7035

Protection category IP to IEC 60 529:

– IP 66 if installed correctly

Note:

– The applicable size may be taken from the relevant product ordering page



Accessories:

– Cable glands made from polyamide or brass, see page 93

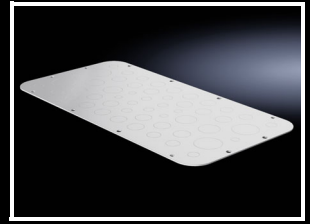

Model No.	2571.100	2572.100	2573.100	2574.100	2575.100	2576.100	2577.100	
Packs of	1 pc(s).	1 pc(s).	1 pc(s).	1 pc(s).	1 pc(s).	1 pc(s).	1 pc(s).	
Gland plate	Size 1	Size 2	Size 3	Size 4	Size 5	Size 6	Size 7	
Dimensions W x D mm	256 x 149	339 x 149	447 x 149	534 x 149	301 x 221	401 x 221	436 x 221	
	Diameter		Number of cable entries					
	M12	2	–	4	1	2	2	6
	M16	2	6	4	6	10	10	10
	M20	9	4	7	8	8	8	8
	M25	5	10	15	11	10	18	20
	M32	1	2	2	6	2	4	4
	M40	1	2	2	4	4	4	4

Size 1

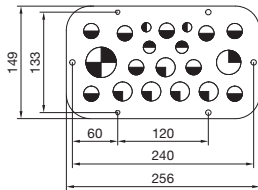

Size 2

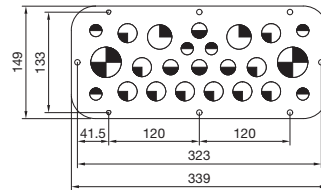

Size 3

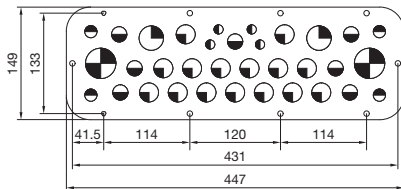

Size 5

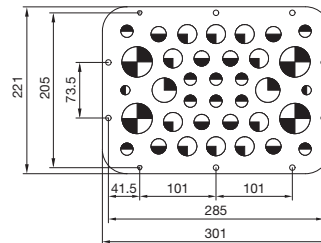

Size 4

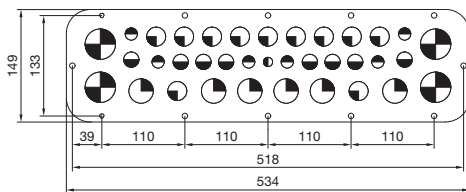

Size 6

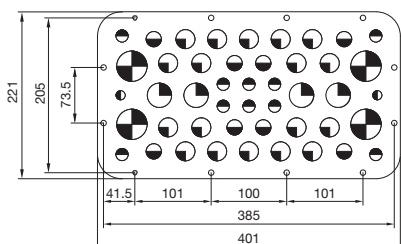

Size 7

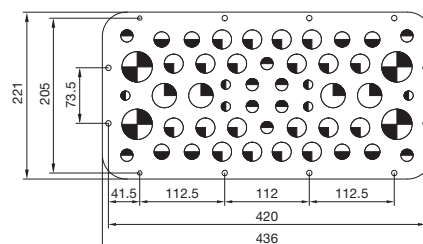

System accessories AX

Gland plates/Connector glands

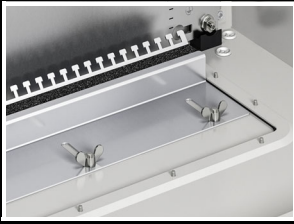

Gland plate

with foam rubber cable clamp strip, for AX

For feeding through pre-fabricated cables when the gland plate has already been fitted to the enclosure. Split gland plates can be sealed using movable plates with a foam rubber cable clamp strip.

Material:

– Gland plate: Sheet steel

Colour:

– RAL 7035

Gland plate size	Dimensions mm	Packs of	Model No.
5	301 x 221	1 pc(s).	2565.400
6	401 x 221	1 pc(s).	2566.400
7	436 x 221	1 pc(s).	2567.400

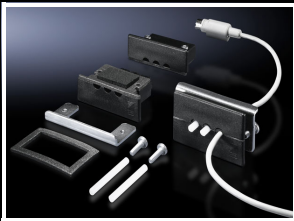

Connector gland, small

For pre-assembled cables with connectors. For use with material thickness of up to 4 mm. Strain relief of the pre-assembled cables can be achieved with cable ties.

Material:

– Plastic

Colour:

– RAL 9005

Protection category IP to IEC 60 529:

– IP 65 if installed correctly

Supply includes:

– Assembly parts

To fit	Packs of	Model No.
2 cables Ø 6 – 8 mm	1 pc(s).	2400.300
3 cables Ø 4 – 6 mm	5 pc(s).	2400.500

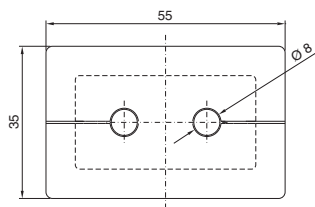

2400.300

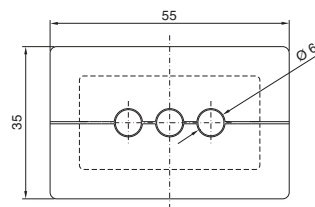

2400.500

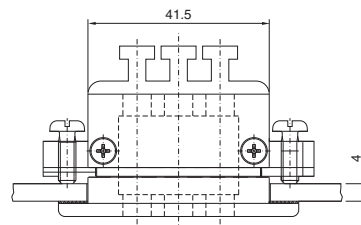
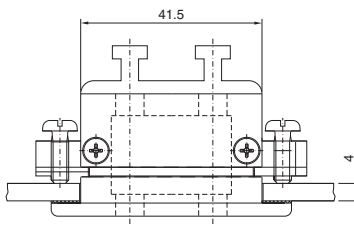
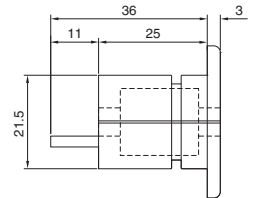

Mounting cut-out

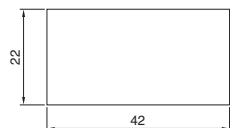

System accessories AX

Cable glands

Cable gland, brass

Benefits:

- Because the gland and lock nut are sold together in a single pack, this saves additional ordering and storage
- Clamping membranes for even tightening and strain relief to protect the cables

Material:

- Brass
- Seal: CR/NBR

Surface finish:

- Nickel-plated

Protection category IP to IEC 60 529:

- IP 68 (5 bar, 30 min.)

Approvals:

- VDE, UR, cUR

Size	Packs of	Model No.
M12 x 1.5	15 pc(s).	2411.801
M16 x 1.5	15 pc(s).	2411.811
M20 x 1.5	10 pc(s).	2411.821
M25 x 1.5	10 pc(s).	2411.831
M32 x 1.5	5 pc(s).	2411.841
M40 x 1.5	4 pc(s).	2411.851
M50 x 1.5	2 pc(s).	2411.861
M63 x 1.5	1 pc(s).	2411.871



Cable gland, polyamide

Benefits:

- Because the gland and lock nut are sold together in a single pack, this saves additional ordering and storage
- Clamping membranes for even tightening and strain relief to protect the cables

Material:

- Polyamide 6
- Seal: CR/NBR

Colour:

- RAL 7035

Protection category IP to IEC 60 529:

- IP 68 (5 bar, 30 min.)

Approvals:

- VDE, UL, cUL, CSA, CSAus

Size	Packs of	Model No.
M12 x 1.5	50 pc(s).	2411.601
M16 x 1.5	50 pc(s).	2411.611
M20 x 1.5	50 pc(s).	2411.621
M25 x 1.5	25 pc(s).	2411.631
M32 x 1.5	15 pc(s).	2411.641
M40 x 1.5	5 pc(s).	2411.651
M50 x 1.5	5 pc(s).	2411.661
M63 x 1.5	3 pc(s).	2411.671



EMC cable gland

The cable sheathing may optionally be interrupted at the contact point or removed completely inside the enclosure.

The cable shielding in the enclosure is retained.

The supplied lock nut cuts automatically into the paint when screwed onto spray-finished enclosure surfaces, thus creating a conductive connection.

Protection category IP to IEC 60 529:

- IP 68

Material:

- Brass
- Seal: CR/NBR

Surface finish:

- Nickel-plated

Approvals:

- VDE, UR, cUR

Cable glands, metric

Size	Cable diameter mm	Minimum shield diameter ¹⁾ mm	Packs of	Model No.
M16	4.5 – 10	3	5 pc(s).	2843.160
M20	6 – 12	5	5 pc(s).	2843.200
M25	11 – 17	8	5 pc(s).	2843.250
M32	15 – 21	10	1 pc(s).	2843.320
M40	19 – 28	15	1 pc(s).	2843.400
M50	27 – 38	19	1 pc(s).	2843.500
M63	34 – 44	30	1 pc(s).	2843.630

¹⁾ Minimum shield diameter = cable diameter minus cable sheathing



LED system light

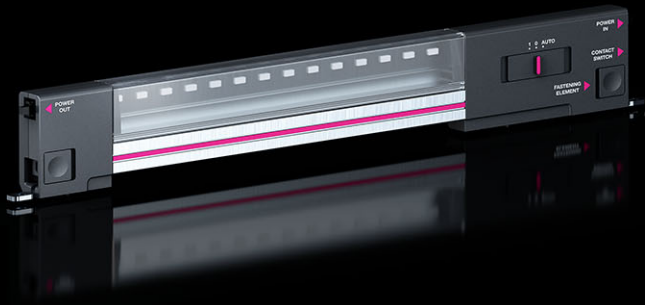

Compact enclosures AX Page 32 **Connection accessories** Page 95

Benefits:

- Optimum illumination of the entire enclosure
- Optionally with clip, screw or magnetic attachment
- Equipment to suit every application

Material:

- Plastic
- Aluminium

Colour:

- Enclosure: RAL 7016

Light colour:

- 4000 K (neutral white)

Supply includes:

- Assembly screws

Note:

- The internal mounting rail AX and the mounting bracket are required when installing in compact enclosures AX, see table
- Connection accessories should be ordered separately
- Further information on country-specific versions can be found on the Internet
- Other system lights, e.g. with a higher luminosity and with motion detector can be found on the Internet

Model No.		2500.114	2500.110	2500.104	2500.100
Output (lumens)		600	600	400	400
Length (mm)		337	337	262	262
Rated operating voltage	100 – 240 V AC	■	■	■	■
Protection class		II (all-insulated)			
Approvals	UL	■	–	■	–
	cUL	■	–	■	–
	CCC	■	■	■	■
	ENEC	■	■	■	■
Installation type	Screw-fastening	■	■	■	■
	Clip attachment	■	■	■	■
	Magnetic attachment to surfaces (accessory)	■	■	■	■
Connection options	Infeed	2-pole	2-pole	2-pole	2-pole
	Through-wiring	2-pole	2-pole	2-pole	2-pole
	Door-operated switch (accessory)	■	■	■	■

Accessories

Rail for interior installation AX		see page 77			
Mounting bracket		6205.100	6205.100	6205.100	6205.100
Mounting kit magnet		2500.490	2500.490	2500.490	2500.490
Door-operated switch		–	2500.460	–	2500.460
Door-operated switch, UL		2500.470	–	2500.470	–

Also required: Connection accessories depending on application type

Infeed, 2-pole		–	2500.420	–	2500.420
Infeed, 2-pole, UL		2500.520	–	2500.520	–
Through-wiring, 2-pole		–	2500.450	–	2500.450
Through-wiring, 2-pole, UL		2500.550	–	2500.550	–

LED system light

Accessories

Connection accessories

for LED system light

The following components can be used for time-saving, easy installation of the lights:



Accessories:

- Cable ties 2597.000

Connection cable for	UL	Length mm	Packs of	Model No. orange
1 Infeed, 2-pole, 100 – 240 V AC	■	3000	1 pc(s).	2500.520
1 Infeed, 2-pole, 100 – 240 V AC	-	3000	5 pc(s).	2500.420
2 Through-wiring, 2-pole, 100 – 240 V AC	■	1000	1 pc(s).	2500.550
2 Through-wiring, 2-pole, 100 – 240 V AC	-	1000	5 pc(s).	2500.450

- A** Connection cable for infeed
- B** Connection cable for through-wiring
- C** Door-operated switch with connection cable (not required for LED system light with integral motion sensor)

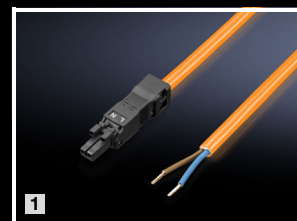
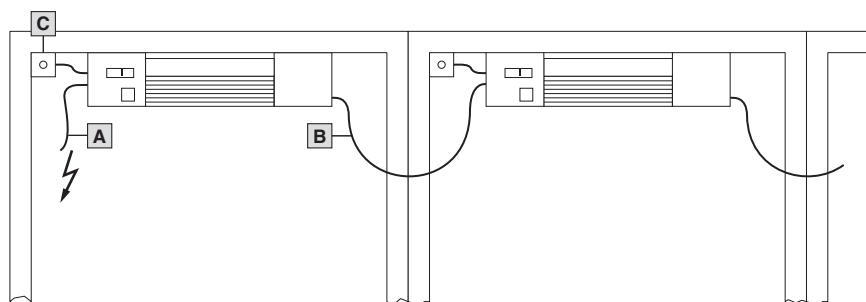

Door-operated switch

with connection cable for LED system light

Supply includes:

- Assembly parts

	ENEC	UL	Length mm	To fit	Packs of	Model No. black
Connection cable	■	-	800	230 V AC/24 V DC, 1 A	1 pc(s).	2500.460
	-	■	800		1 pc(s).	2500.470



Mounting kit magnet

for LED system light

For sticking onto the rear of lights without a socket.

Packs of	Model No.
2 pc(s).	2500.490

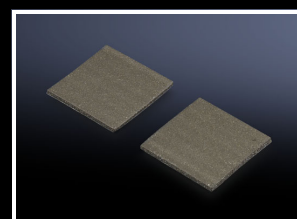



TERMINAL BOXES KX – MORE **PRECISE**

Consistent use of self-centring mini cam locks that can be installed without needing tools increases the level of precision and the size of the access opening.







Full utilisation of space

The support rails can be mounted either on the front of the integrated perforated mounting strip or, for better utilisation of the enclosure depth, directly on the enclosure's rear panel.

Precision

The mini cam lock works almost instantaneously. A quarter of a turn is sufficient to correctly centre the cover while locking; this ensures all-round air-tight positioning.



Reliability

The deliberately slimline enclosure edge fold provides broad, secure contact with the seamless PU foam seal and helps preserve the protection category of IP 66.



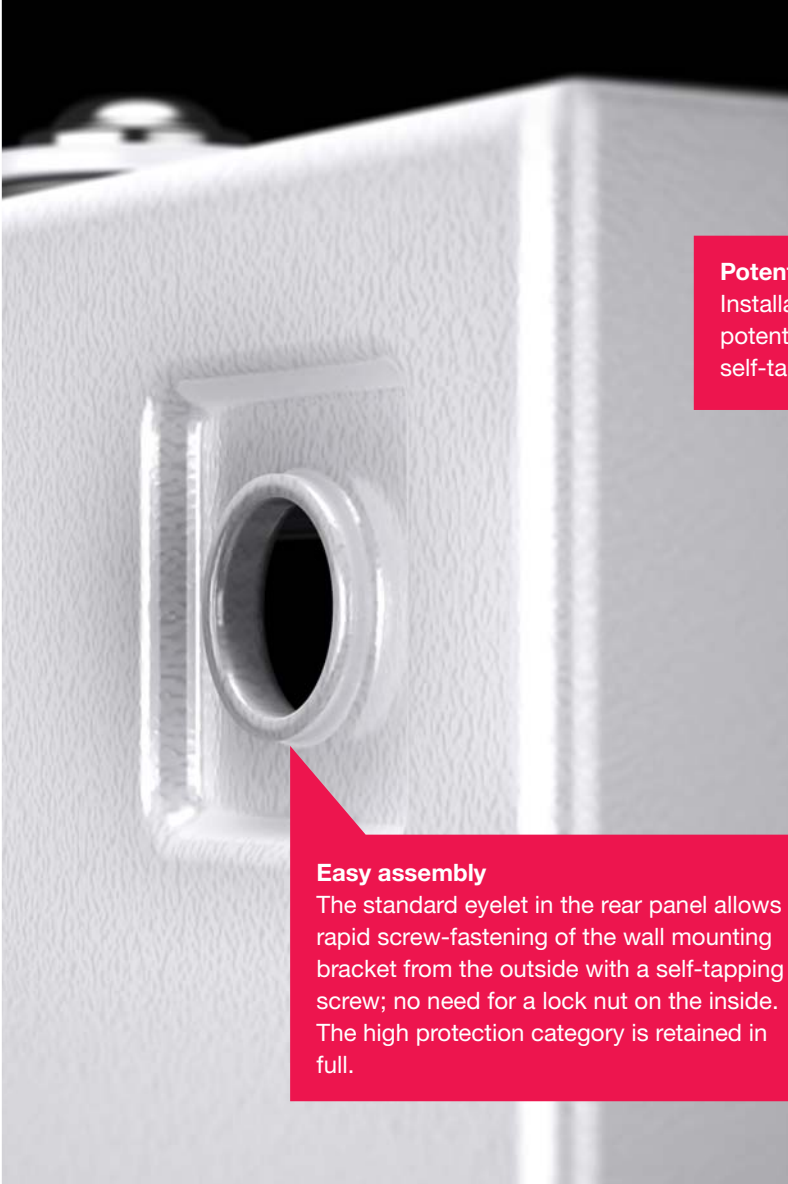

Potential equalisation

Installation of the gland plate includes automatic potential equalisation. Contact is made by two self-tapping screws guided through special holes.

Easy assembly

The standard eyelet in the rear panel allows rapid screw-fastening of the wall mounting bracket from the outside with a self-tapping screw; no need for a lock nut on the inside. The high protection category is retained in full.



Protection category maintained

The seamless PU foam gasket makes it possible to maintain the protection category within a temperature range of -20 °C to +80 °C and can be overpainted if necessary.

Earthing

The PE conductor connection enables extremely quick and easy earthing, even retrospectively.

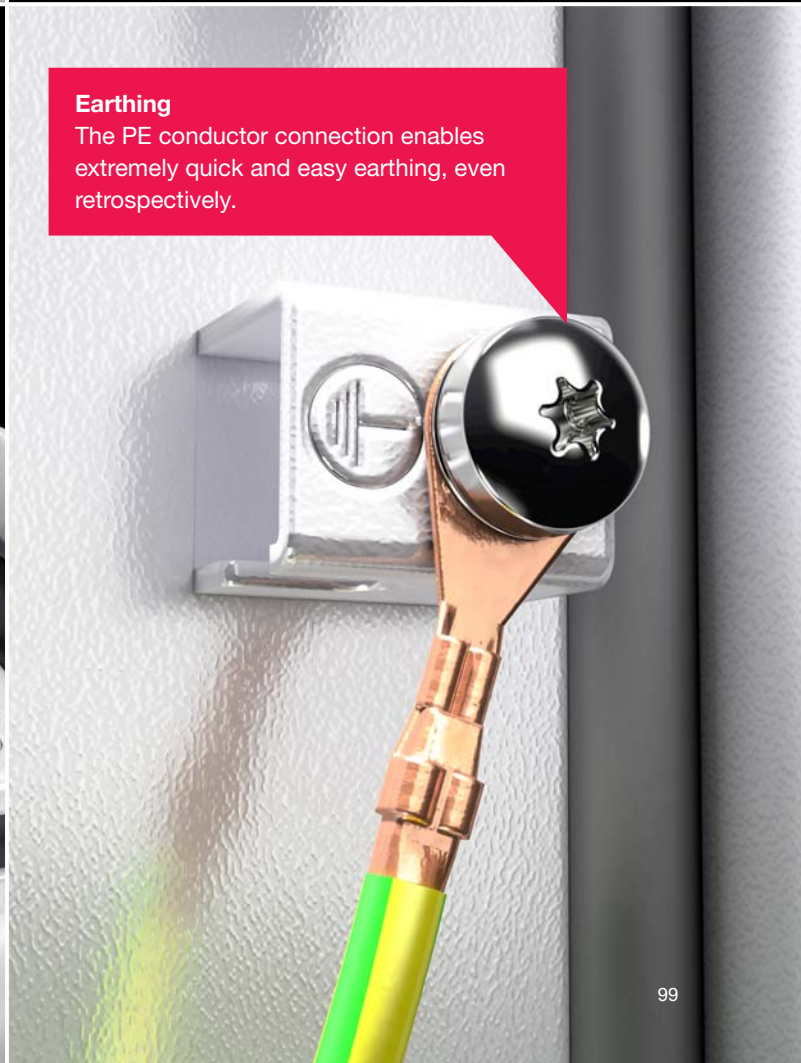

Small enclosures KX



System accessories Page 124

Material:

- Enclosure: Sheet steel
- Cover: Sheet steel, all-round foamed-in PU seal

Surface finish:

- Enclosure and cover: Dipcoat-primed, powder-coated on the outside, textured paint

Colour:

- RAL 7035

Protection category IP to IEC 60 529:

- IP 66

Protection category NEMA:

- NEMA 4

Supply includes:

- Enclosure with cover
- Mini cam locks

Approvals:

- UL
- cUL
- Bureau Veritas
- Lloyds Register
- DNV-GL

Further approvals can be found on the Internet.

Terminal boxes KX, sheet steel, without gland plate

Width mm	Packs of	150	200	200	300	300	400	Page
Height mm		150	150	200	150	200	200	
Depth mm		80	80	80	80	80	80	
Material thickness – enclosure mm		1.25	1.25	1.25	1.25	1.25	1.25	
Material thickness – cover mm		1.25	1.25	1.25	1.25	1.25	1.25	
Model No.	1 pc(s).	1514.000	1528.000	1516.000	1515.000	1517.000	1518.000	
Weight kg		1.40	1.45	1.80	1.90	2.39	3.01	
Mini cam lock		4	4	4	4	4	4	

Accessories

Wall mounting bracket, for AX sheet steel, KX sheet steel	4 pc(s).	1590.010	1590.010	1590.010	1590.010	1590.010	1590.010	126
Pole clamp	2 pc(s).	2584.100	2584.100	2584.100	2584.100	2584.100	2584.100	128
Mounting plates	1 pc(s).	1560.800	1575.800	1562.800	1561.800	1563.800	1564.800	129
Support rails TS 35/7.5	10 pc(s).	2314.000	2315.000	2315.000	2316.000	2316.000	2317.000	129
Support rails TS 35/15		–	–	–	–	–	–	
Mounting clip for support rails	30 pc(s).	2309.000	2309.000	2309.000	2309.000	2309.000	2309.000	130
Mounting bracket	4 pc(s).	4597.000	4597.000	4597.000	4597.000	4597.000	4597.000	81
Rail mounting bracket	20 pc(s).	2365.000	2365.000	2365.000	2365.000	2365.000	2365.000	81
Mounting claw for second mounting level	20 pc(s).	2309.100	2309.100	2309.100	2309.100	2309.100	2309.100	130
Cover hinge	6 pc(s).	1592.200	1592.200	1592.200	1592.200	1592.200	1592.200	125
Earth straps	5 pc(s).	2565.100	2565.100	2565.100	2565.100	2565.100	2565.100	130
Baying kit		–	–	–	–	–	–	
Pressure relief stopper	5 pc(s).	2459.500	2459.500	2459.500	2459.500	2459.500	2459.500	124
Condensate discharge	6 pc(s).	2459.000	2459.000	2459.000	2459.000	2459.000	2459.000	124
Self-tapping screws	300 pc(s).	2487.000	2487.000	2487.000	2487.000	2487.000	2487.000	82
Connector gland, small	5 pc(s).	2400.500	2400.500	2400.500	2400.500	2400.500	2400.500	131

Small enclosures KX

Terminal boxes KX, sheet steel, without gland plate

Width mm	Packs of	150	200	200	300	300	Page
Height mm		150	150	200	150	200	
Depth mm		120	120	120	120	120	
Material thickness – enclosure mm		1.25	1.25	1.25	1.25	1.25	
Material thickness – cover mm		1.25	1.25	1.25	1.25	1.25	
Model No.	1 pc(s).	1500.000	1529.000	1502.000	1501.000	1503.000	
Weight kg		1.46	1.75	2.13	2.32	2.69	
Mini cam lock		4	4	4	4	4	

Accessories

Wall mounting bracket, for AX sheet steel, KX sheet steel	4 pc(s).	1590.010	1590.010	1590.010	1590.010	1590.010	126
Pole clamp	2 pc(s).	2584.100	2584.100	2584.100	2584.100	2584.100	128
Mounting plates	1 pc(s).	1560.800	1575.800	1562.800	1561.800	1563.800	129
Support rails TS 35/7.5	10 pc(s).	2314.000	2315.000	2315.000	2316.000	2316.000	129
Support rails TS 35/15		–	–	–	–	–	
Mounting clip for support rails	30 pc(s).	2309.000	2309.000	2309.000	2309.000	2309.000	130
Mounting bracket	4 pc(s).	4597.000	4597.000	4597.000	4597.000	4597.000	81
Rail mounting bracket	20 pc(s).	2366.000	2366.000	2366.000	2366.000	2366.000	81
Mounting claw for second mounting level	20 pc(s).	2309.100	2309.100	2309.100	2309.100	2309.100	130
Cover hinge	6 pc(s).	1592.200	1592.200	1592.200	1592.200	1592.200	125
Earth straps	5 pc(s).	2565.050	2565.050	2565.050	2565.050	2565.050	130
Baying kit	1 pc(s).	1199.100	1199.100	1199.100	1199.100	1199.100	124
Pressure relief stopper	5 pc(s).	2459.500	2459.500	2459.500	2459.500	2459.500	124
Condensate discharge	6 pc(s).	2459.000	2459.000	2459.000	2459.000	2459.000	124
Self-tapping screws	300 pc(s).	2487.000	2487.000	2487.000	2487.000	2487.000	82
Connector gland, small	5 pc(s).	2400.500	2400.500	2400.500	2400.500	2400.500	131

Terminal boxes KX, sheet steel, without gland plate

Width mm	Packs of	300	400	400	400	400	500	Page
Height mm		300	150	200	300	400	200	
Depth mm		120	120	120	120	120	120	
Material thickness – enclosure mm		1.25	1.25	1.25	1.25	1.25	1.25	
Material thickness – cover mm		1.25	1.25	1.25	1.25	1.25	1.25	
Model No.	1 pc(s).	1507.000	1589.000	1504.000	1508.000	1511.000	1505.000	
Weight kg		3.78	2.98	3.42	4.70	5.67	4.18	
Mini cam lock		4	4	4	4	4	4	

Accessories

Wall mounting bracket, for AX sheet steel, KX sheet steel	4 pc(s).	1590.010	1590.010	1590.010	1590.010	1590.010	1590.010	126
Pole clamp	2 pc(s).	2584.100	2584.100	2584.100	2584.100	2584.100	2584.100	128
Mounting plates	1 pc(s).	1567.800	1576.800	1564.800	1568.800	1571.800	1565.800	129
Support rails TS 35/7.5	10 pc(s).	2316.000	2317.000	2317.000	2317.000	2317.000	–	129
Support rails TS 35/15	10 pc(s).	–	–	–	–	–	2318.000	129
Mounting clip for support rails	30 pc(s).	2309.000	2309.000	2309.000	2309.000	2309.000	2309.000	130
Mounting bracket	4 pc(s).	4597.000	4597.000	4597.000	4597.000	4597.000	4597.000	81
Rail mounting bracket	20 pc(s).	2366.000	2366.000	2366.000	2366.000	2366.000	2366.000	81
Mounting claw for second mounting level	20 pc(s).	2309.100	2309.100	2309.100	2309.100	2309.100	2309.100	130
Cover hinge	6 pc(s).	1592.200	1592.200	1592.200	1592.200	1592.200	1592.200	125
Earth straps	5 pc(s).	2565.050	2565.050	2565.050	2565.050	2565.050	2565.050	130
Baying kit	1 pc(s).	1199.100	1199.100	1199.100	1199.100	1199.100	1199.100	124
Pressure relief stopper	5 pc(s).	2459.500	2459.500	2459.500	2459.500	2459.500	2459.500	124
Condensate discharge	6 pc(s).	2459.000	2459.000	2459.000	2459.000	2459.000	2459.000	124
Self-tapping screws	300 pc(s).	2487.000	2487.000	2487.000	2487.000	2487.000	2487.000	82
Connector gland, small	5 pc(s).	2400.500	2400.500	2400.500	2400.500	2400.500	2400.500	131

Small enclosures KX

Terminal boxes KX, sheet steel, without gland plate

Width mm	Packs of	500	600	600	600	800	800	Page
Height mm		300	200	300	400	200	400	
Depth mm		120	120	120	120	120	120	
Material thickness – enclosure mm		1.25	1.25	1.25	1.25	1.25	1.25	
Material thickness – cover mm		1.25	1.25	1.25	1.25	1.25	1.25	
Model No.	1 pc(s).	1509.000	1506.000	1510.000	1512.000	1527.000	1513.000	
Weight kg		5.57	4.92	6.28	8.35	6.45	11.00	
Mini cam lock		4	6	6	6	6	6	
Accessories								
Wall mounting bracket, for AX sheet steel, KX sheet steel	4 pc(s).	1590.010	1590.010	1590.010	1590.010	1590.010	1590.010	126
Pole clamp	2 pc(s).	2584.100	2584.100	2584.100	2584.100	2584.100	2584.100	128
Mounting plates	1 pc(s).	1569.800	1566.800	1570.800	1572.800	1574.800	1573.800	129
Support rails TS 35/7.5		–	–	–	–	–	–	
Support rails TS 35/15	10 pc(s).	2318.000	2319.000	2319.000	2319.000	–	–	129
Mounting clip for support rails	30 pc(s).	2309.000	2309.000	2309.000	2309.000	2309.000	2309.000	130
Mounting bracket	4 pc(s).	4597.000	4597.000	4597.000	4597.000	4597.000	4597.000	81
Rail mounting bracket	20 pc(s).	2366.000	2366.000	2366.000	2366.000	2366.000	2366.000	81
Mounting claw for second mounting level	20 pc(s).	2309.100	2309.100	2309.100	2309.100	2309.100	2309.100	130
Cover hinge	6 pc(s).	1592.200	1592.200	1592.200	1592.200	1592.200	1592.200	125
Earth straps	5 pc(s).	2565.050	2565.050	2565.050	2565.050	2565.050	2565.050	130
Baying kit	1 pc(s).	1199.100	1199.100	1199.100	1199.100	1199.100	1199.100	124
Pressure relief stopper	5 pc(s).	2459.500	2459.500	2459.500	2459.500	2459.500	2459.500	124
Condensate discharge	6 pc(s).	2459.000	2459.000	2459.000	2459.000	2459.000	2459.000	124
Self-tapping screws	300 pc(s).	2487.000	2487.000	2487.000	2487.000	2487.000	2487.000	82
Connector gland, small	5 pc(s).	2400.500	2400.500	2400.500	2400.500	2400.500	2400.500	131

Rittal – The System.



Perforex
Milling Terminal MT

www.rittal.com/automation



System accessories Page 124

Material:

- Enclosure: Sheet steel
- Cover: Sheet steel, all-round foamed-in PU seal

Surface finish:

- Enclosure and cover: Dipcoated, powder-coated on the outside, textured paint

Colour:

- RAL 7035

Protection category IP to IEC 60 529:

- IP 55

Protection category NEMA:

- NEMA 12

Supply includes:

- Enclosure with cover
- Mini cam locks
- Sheet steel gland plates with seals and assembly parts

Approvals:

- UL
 - cUL
 - Bureau Veritas
 - Lloyds Register
 - DNV-GL
- Further approvals can be found on the Internet.

Terminal boxes KX, sheet steel, with gland plate

Width mm	Packs of	300	300	300	400	400	400	500	Page
Height mm		150	200	300	200	300	400	200	
Depth mm		120	120	120	120	120	120	120	
Material thickness – enclosure mm		1.25	1.25	1.25	1.25	1.25	1.25	1.25	
Material thickness – cover mm		1.25	1.25	1.25	1.25	1.25	1.25	1.25	
Model No.	1 pc(s).	1530.000	1531.000	1535.000	1532.000	1536.000	1539.000	1533.000	
Weight kg		2.62	3.12	4.47	3.82	5.40	6.61	4.73	
Mini cam lock		4	4	4	4	4	4	4	
Gland plate (top + bottom), qty.		1 + 1	1 + 1	1 + 1	1 + 1	1 + 1	1 + 1	2 + 2	
Gland plate (left + right), qty.		–	–	1 + 1	–	1 + 1	1 + 1	–	
Accessories									
Wall mounting bracket, for AX sheet steel, KX sheet steel	4 pc(s).	1590.010	1590.010	1590.010	1590.010	1590.010	1590.010	1590.010	126
Pole clamp	2 pc(s).	2584.100	2584.100	2584.100	2584.100	2584.100	2584.100	2584.100	128
Mounting plates	1 pc(s).	1561.800	1563.800	1567.800	1564.800	1568.800	1571.800	1565.800	129
Support rails TS 35/7.5	10 pc(s).	2316.000	2316.000	2316.000	2317.000	2317.000	2317.000	–	129
Support rails TS 35/15		–	–	–	–	–	–	–	
Mounting clip for support rails	30 pc(s).	2309.000	2309.000	2309.000	2309.000	2309.000	2309.000	2309.000	130
Mounting bracket	4 pc(s).	4597.000	4597.000	4597.000	4597.000	4597.000	4597.000	4597.000	81
Rail mounting bracket	20 pc(s).	2366.000	2366.000	2366.000	2366.000	2366.000	2366.000	2366.000	81
Mounting claw for second mounting level	20 pc(s).	2309.100	2309.100	2309.100	2309.100	2309.100	2309.100	2309.100	130
Cover hinge	6 pc(s).	1592.200	1592.200	1592.200	1592.200	1592.200	1592.200	1592.200	125
Metal gland plates	1 pc(s).	1581.200	1581.200	1581.200	1581.200	1581.200	1581.200	1581.200	131
Earth straps	5 pc(s).	2565.050	2565.050	2565.050	2565.050	2565.050	2565.050	2565.050	130
Baying kit	1 pc(s).	1199.100	1199.100	1199.100	1199.100	1199.100	1199.100	1199.100	124
Pressure relief stopper	5 pc(s).	2459.500	2459.500	2459.500	2459.500	2459.500	2459.500	2459.500	124
Condensate discharge	6 pc(s).	2459.000	2459.000	2459.000	2459.000	2459.000	2459.000	2459.000	124
Self-tapping screws	300 pc(s).	2487.000	2487.000	2487.000	2487.000	2487.000	2487.000	2487.000	82
Connector gland, small	5 pc(s).	2400.500	2400.500	2400.500	2400.500	2400.500	2400.500	2400.500	131

Small enclosures KX

Terminal boxes KX, sheet steel, with gland plate

Width mm	Packs of	500	600	600	800	Page
Height mm		300	300	400	400	
Depth mm		120	120	120	120	
Material thickness – enclosure mm		1.25	1.25	1.25	1.25	
Material thickness – cover mm		1.25	1.25	1.25	1.25	
Model No.	1 pc(s).	1537.000	1538.000	1540.000	1541.000	
Weight kg		6.01	7.02	9.32	11.10	
Mini cam lock		4	6	6	6	
Gland plate (top + bottom), qty.		2 + 2	2 + 2	2 + 2	3 + 3	
Gland plate (left + right), qty.		1 + 1	1 + 1	1 + 1	1 + 1	
Accessories						
Wall mounting bracket, for AX sheet steel, KX sheet steel	4 pc(s).	1590.010	1590.010	1590.010	1590.010	126
Pole clamp	2 pc(s).	2584.100	2584.100	2584.100	2584.100	128
Mounting plates	1 pc(s).	1569.800	1570.800	1572.800	1573.800	129
Support rails TS 35/7.5		–	–	–	–	
Support rails TS 35/15	10 pc(s).	2318.000	2319.000	2319.000	–	129
Mounting clip for support rails	30 pc(s).	2309.000	2309.000	2309.000	2309.000	130
Mounting bracket	4 pc(s).	4597.000	4597.000	4597.000	4597.000	81
Rail mounting bracket	20 pc(s).	2366.000	2366.000	2366.000	2366.000	81
Mounting claw for second mounting level	20 pc(s).	2309.100	2309.100	2309.100	2309.100	130
Cover hinge	6 pc(s).	1592.200	1592.200	1592.200	1592.200	125
Metal gland plates	1 pc(s).	1581.200	1581.200	1581.200	1581.200	131
Earth straps	5 pc(s).	2565.050	2565.050	2565.050	2565.050	130
Baying kit	1 pc(s).	1199.100	1199.100	1199.100	1199.100	124
Pressure relief stopper	5 pc(s).	2459.500	2459.500	2459.500	2459.500	124
Condensate discharge	6 pc(s).	2459.000	2459.000	2459.000	2459.000	124
Self-tapping screws	300 pc(s).	2487.000	2487.000	2487.000	2487.000	82
Connector gland, small	5 pc(s).	2400.500	2400.500	2400.500	2400.500	131

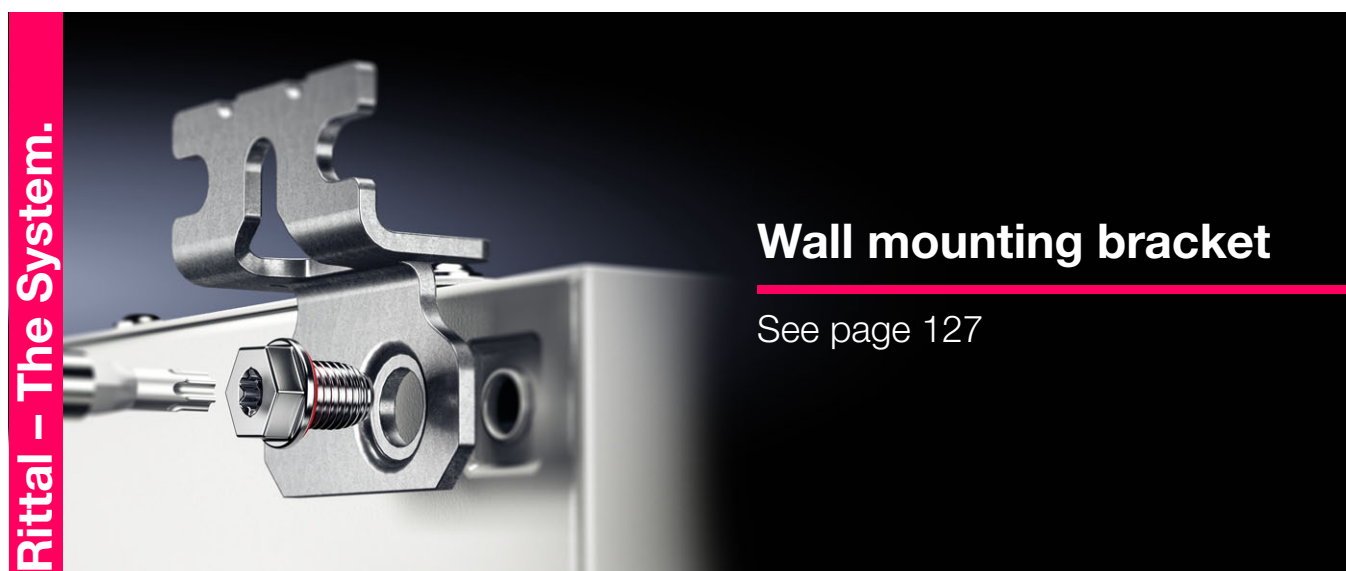

Rittal – The System.

Wall mounting bracket

See page 127

AX. KX. SYSTEM PERFECTION.

Lock systems



ENCLOSURES

POWER DISTRIBUTION

CLIMATE CONTROL

IT INFRASTRUCTURE

SOFTWARE & SERVICES



FRIEDHELM LOH GROUP



E-BOX KX – MORE **TIME SAVED**

Simplified machining boosts efficiency, thanks to the door being supplied loose and tool-free cam lock installation.





Ample space

The 180° door hinges create more space and improve access to the enclosure interior.



Peace of mind

The cam lock with double-bit insert can be installed without using tools, locks the enclosure securely and can be incorporated into custom locking systems.



Reliability

The deliberately slimline enclosure edge fold provides broad, secure contact with the seamless PU foam seal and helps preserve the protection category of IP 66.





Speed

The mounting plate and door can be removed from the packaging and passed straight on for machining.



Easy assembly

The standard eyelet in the rear panel allows rapid screw-fastening of the wall mounting bracket from the outside with a self-tapping screw; no need for a lock nut on the inside. The high protection category is retained in full.



Protection category maintained

The seamless PU foam gasket makes it possible to maintain the protection category within a temperature range of $-20\text{ }^{\circ}\text{C}$ to $+80\text{ }^{\circ}\text{C}$ and can be overpainted if necessary.



Earthing

The PE conductor connection enables extremely quick and easy earthing, even retrospectively.

Small enclosures KX



System accessories Page 124

Material:

- Enclosure: Sheet steel
- Door: Sheet steel, all-round foamed-in PU seal

Surface finish:

- Enclosure and door: Dipcoat-primed, powder-coated on the outside, textured paint
- Mounting plate: Zinc-plated

Colour:

- RAL 7035

Protection category IP to IEC 60 529:

- IP 66

Protection category NEMA:

- NEMA 4

Supply includes:

- Enclosure with door
- Mounting plate
- Cam lock with 3 mm double-bit insert

Approvals:

- UL
- cUL
- Bureau Veritas
- Lloyds Register
- DNV-GL

Further approvals can be found on the Internet.

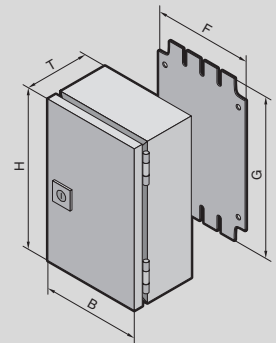

E-Box KX, sheet steel, depth 80 mm

Width (B) mm	Packs of	150	150	200	200	200	Page
Height (H) mm		150	300	200	300	400	
Depth (T) mm		80	80	80	80	80	
Mounting plate width (F) mm		125	125	175	175	175	
Mounting plate height (G) mm		135	285	185	285	385	
Material thickness – enclosure mm		1.25	1.25	1.25	1.25	1.25	
Material thickness – door mm		1.25	1.25	1.25	1.25	1.25	
Material thickness – mounting plate mm		2.0	2.0	2.0	2.0	2.0	
Model No.	1 pc(s).	1551.000	1545.000	1546.000	1552.000	1547.000	
Weight kg		1.49	2.54	2.26	3.18	4.15	
Accessories							
Wall mounting bracket, for AX sheet steel, KX sheet steel	4 pc(s).	1590.010	1590.010	1590.010	1590.010	1590.010	126
Pole clamp	2 pc(s).	2584.100	2584.100	2584.100	2584.100	2584.100	128
Support rails TS 35/7.5	10 pc(s).	2314.000	2314.000	2315.000	2315.000	2315.000	129
Mounting clip for support rails	30 pc(s).	2309.000	2309.000	2309.000	2309.000	2309.000	130
Mounting bracket	4 pc(s).	4597.000	4597.000	4597.000	4597.000	4597.000	81
Rail mounting bracket	20 pc(s).	2365.000	2365.000	2365.000	2365.000	2365.000	81
Mini-comfort handle AX for lock inserts or profile half-cylinders	1 pc(s).	2537.100	2537.100	2537.100	2537.100	2537.100	125
Mini-comfort handle AX for padlocks and lock inserts or profile half-cylinders	1 pc(s).	2537.300	2537.300	2537.300	2537.300	2537.300	125
Lock insert 7 mm square	1 pc(s).	2460.000	2460.000	2460.000	2460.000	2460.000	66
Lock insert 8 mm square	1 pc(s).	2461.000	2461.000	2461.000	2461.000	2461.000	66
Lock insert 7 mm triangular	1 pc(s).	2462.000	2462.000	2462.000	2462.000	2462.000	66
Lock insert 8 mm triangular	1 pc(s).	2463.000	2463.000	2463.000	2463.000	2463.000	66
Lock insert, screwdriver	1 pc(s).	2464.000	2464.000	2464.000	2464.000	2464.000	66
Lock insert Daimler	1 pc(s).	2465.000	2465.000	2465.000	2465.000	2465.000	66
Lock insert 3 mm double-bit	1 pc(s).	2466.000	2466.000	2466.000	2466.000	2466.000	66
Lock insert Fiat	1 pc(s).	2307.000	2307.000	2307.000	2307.000	2307.000	66
Lock insert 6.5 mm triangular	1 pc(s).	2460.650	2460.650	2460.650	2460.650	2460.650	66
Earth straps	5 pc(s).	2565.100	2565.100	2565.100	2565.100	2565.100	130
Pressure relief stopper	5 pc(s).	2459.500	2459.500	2459.500	2459.500	2459.500	124
Condensate discharge	6 pc(s).	2459.000	2459.000	2459.000	2459.000	2459.000	124
Self-tapping screws	300 pc(s).	2487.000	2487.000	2487.000	2487.000	2487.000	82
Connector gland, small	5 pc(s).	2400.500	2400.500	2400.500	2400.500	2400.500	131

Rittal – The System.



Mini-comfort handle AX

See page 125

Small enclosures KX

E-Box KX, sheet steel, depth 120 mm

Width (B) mm	Packs of	150	150	200	200	200	200	300	300	Page
Height (H) mm		150	300	200	300	400	500	300	400	
Depth (T) mm		120	120	120	120	120	120	120	120	
Mounting plate width (F) mm		125	125	175	175	175	175	275	275	
Mounting plate height (G) mm		135	285	185	285	385	485	285	385	
Material thickness – enclosure mm		1.25	1.25	1.25	1.25	1.25	1.25	1.25	1.25	
Material thickness – door mm		1.25	1.25	1.25	1.25	1.25	1.25	1.25	1.25	
Material thickness – mounting plate mm		2.0	2.0	2.0	2.0	2.0	2.0	2.0	2.0	
Model No.	1 pc(s).	1553.000	1548.000	1549.000	1554.000	1550.000	1557.000	1555.000	1556.000	
Weight kg		1.72	2.93	2.64	3.63	4.62	5.57	5.14	6.38	

Accessories

Wall mounting bracket, for AX sheet steel, KX sheet steel	4 pc(s).	1590.010	1590.010	1590.010	1590.010	1590.010	1590.010	1590.010	1590.010	126
Pole clamp	2 pc(s).	2584.100	2584.100	2584.100	2584.100	2584.100	2584.100	2584.100	2584.100	128
Support rails TS 35/7.5	10 pc(s).	2314.000	2314.000	2315.000	2315.000	2315.000	2315.000	2316.000	2316.000	129
Mounting clip for support rails	30 pc(s).	2309.000	2309.000	2309.000	2309.000	2309.000	2309.000	2309.000	2309.000	130
Mounting bracket	4 pc(s).	4597.000	4597.000	4597.000	4597.000	4597.000	4597.000	4597.000	4597.000	81
Rail mounting bracket	20 pc(s).	2366.000	2366.000	2366.000	2366.000	2366.000	2366.000	2366.000	2366.000	81
Mini-comfort handle AX for lock inserts or profile half-cylinders	1 pc(s).	2537.100	2537.100	2537.100	2537.100	2537.100	2537.100	2537.100	2537.100	125
Mini-comfort handle AX for padlocks and lock inserts or profile half-cylinders	1 pc(s).	2537.300	2537.300	2537.300	2537.300	2537.300	2537.300	2537.300	2537.300	125
Lock insert 7 mm square	1 pc(s).	2460.000	2460.000	2460.000	2460.000	2460.000	2460.000	2460.000	2460.000	66
Lock insert 8 mm square	1 pc(s).	2461.000	2461.000	2461.000	2461.000	2461.000	2461.000	2461.000	2461.000	66
Lock insert 7 mm triangular	1 pc(s).	2462.000	2462.000	2462.000	2462.000	2462.000	2462.000	2462.000	2462.000	66
Lock insert 8 mm triangular	1 pc(s).	2463.000	2463.000	2463.000	2463.000	2463.000	2463.000	2463.000	2463.000	66
Lock insert, screwdriver	1 pc(s).	2464.000	2464.000	2464.000	2464.000	2464.000	2464.000	2464.000	2464.000	66
Lock insert Daimler	1 pc(s).	2465.000	2465.000	2465.000	2465.000	2465.000	2465.000	2465.000	2465.000	66
Lock insert 3 mm double-bit	1 pc(s).	2466.000	2466.000	2466.000	2466.000	2466.000	2466.000	2466.000	2466.000	66
Lock insert Fiat	1 pc(s).	2307.000	2307.000	2307.000	2307.000	2307.000	2307.000	2307.000	2307.000	66
Lock insert 6.5 mm triangular	1 pc(s).	2460.650	2460.650	2460.650	2460.650	2460.650	2460.650	2460.650	2460.650	66
Earth straps	5 pc(s).	2565.050	2565.050	2565.050	2565.050	2565.050	2565.050	2565.050	2565.050	130
Baying kit	1 pc(s).	1199.100	1199.100	1199.100	1199.100	1199.100	1199.100	1199.100	1199.100	124
Pressure relief stopper	5 pc(s).	2459.500	2459.500	2459.500	2459.500	2459.500	2459.500	2459.500	2459.500	124
Condensate discharge	6 pc(s).	2459.000	2459.000	2459.000	2459.000	2459.000	2459.000	2459.000	2459.000	124
Self-tapping screws	300 pc(s).	2487.000	2487.000	2487.000	2487.000	2487.000	2487.000	2487.000	2487.000	82
Connector gland, small	5 pc(s).	2400.500	2400.500	2400.500	2400.500	2400.500	2400.500	2400.500	2400.500	131

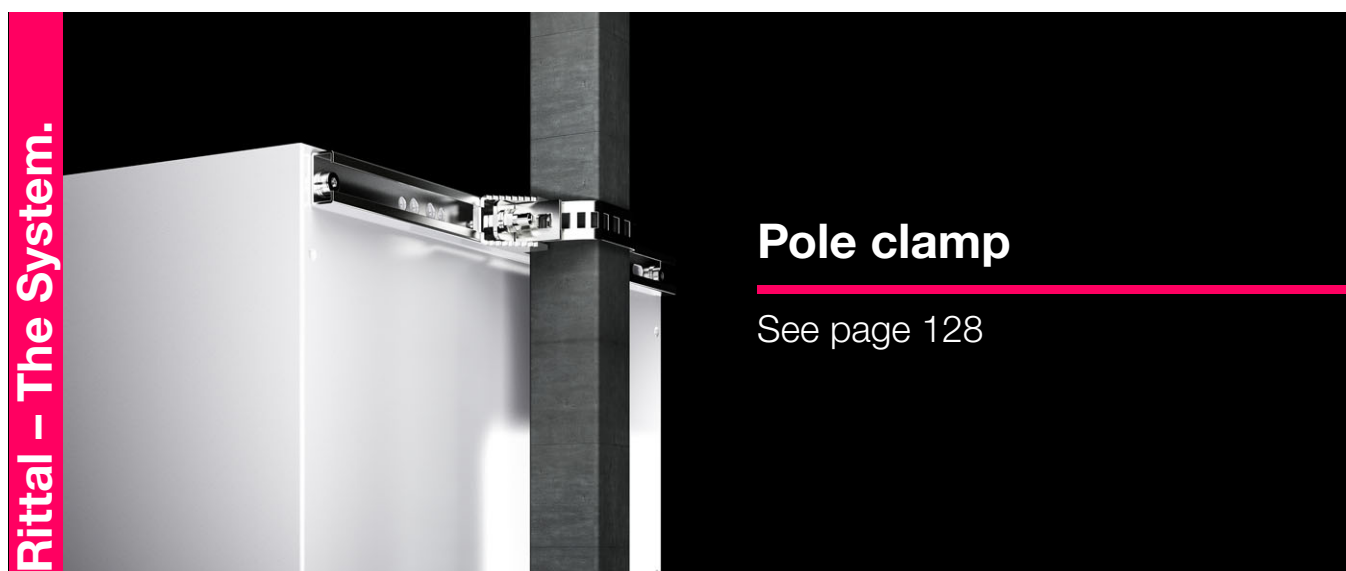

Rittal – The System.

Pole clamp

See page 128

E-Box KX, sheet steel, depth 155 mm

Width (B) mm	Packs of	200	300	300	300	300	380	Page
Height (H) mm		300	300	400	600	800	300	
Depth (T) mm		155	155	155	155	155	155	
Mounting plate width (F) mm		175	275	275	275	275	365	
Mounting plate height (G) mm		285	285	385	585	785	275	
Material thickness – enclosure mm		1.25	1.25	1.25	1.25	1.25	1.25	
Material thickness – door mm		1.25	1.25	1.25	1.25	1.25	1.25	
Material thickness – mounting plate mm		2.0	2.0	2.0	2.0	2.0	2.0	
Model No.	1 pc(s).	1574.000	1575.000	1577.000	1578.000	1579.000	1576.000	
Weight kg		3.98	5.50	6.98	10.30	12.80	6.64	

Accessories

Wall mounting bracket, for AX sheet steel, KX sheet steel	4 pc(s).	1590.010	1590.010	1590.010	1590.010	1590.010	1590.010	126
Pole clamp	2 pc(s).	2584.100	2584.100	2584.100	2584.100	2584.100	2584.100	128
Support rails TS 35/7.5	10 pc(s).	2315.000	2316.000	2316.000	2316.000	2316.000	2317.000 ¹⁾	129
Mounting clip for support rails	30 pc(s).	2309.000	2309.000	2309.000	2309.000	2309.000	2309.000	130
Mounting bracket	4 pc(s).	4597.000	4597.000	4597.000	4597.000	4597.000	4597.000	81
Rail mounting bracket	20 pc(s).	2366.000	2366.000	2366.000	2366.000	2366.000	2366.000	81
Mini-comfort handle AX for lock inserts or profile half-cylinders	1 pc(s).	2537.100	2537.100	2537.100	2537.100	2537.100	2537.100	125
Mini-comfort handle AX for padlocks and lock inserts or profile half-cylinders	1 pc(s).	2537.300	2537.300	2537.300	2537.300	2537.300	2537.300	125
Lock insert 7 mm square	1 pc(s).	2460.000	2460.000	2460.000	2460.000	2460.000	2460.000	66
Lock insert 8 mm square	1 pc(s).	2461.000	2461.000	2461.000	2461.000	2461.000	2461.000	66
Lock insert 7 mm triangular	1 pc(s).	2462.000	2462.000	2462.000	2462.000	2462.000	2462.000	66
Lock insert 8 mm triangular	1 pc(s).	2463.000	2463.000	2463.000	2463.000	2463.000	2463.000	66
Lock insert, screwdriver	1 pc(s).	2464.000	2464.000	2464.000	2464.000	2464.000	2464.000	66
Lock insert Daimler	1 pc(s).	2465.000	2465.000	2465.000	2465.000	2465.000	2465.000	66
Lock insert 3 mm double-bit	1 pc(s).	2466.000	2466.000	2466.000	2466.000	2466.000	2466.000	66
Lock insert Fiat	1 pc(s).	2307.000	2307.000	2307.000	2307.000	2307.000	2307.000	66
Lock insert 6.5 mm triangular	1 pc(s).	2460.650	2460.650	2460.650	2460.650	2460.650	2460.650	66
Earth straps	5 pc(s).	2565.050	2565.050	2565.050	2565.050	2565.050	2565.050	130
Baying kit	1 pc(s).	1199.100	1199.100	1199.100	1199.100	1199.100	1199.100	124
Pressure relief stopper	5 pc(s).	2459.500	2459.500	2459.500	2459.500	2459.500	2459.500	124
Condensate discharge	6 pc(s).	2459.000	2459.000	2459.000	2459.000	2459.000	2459.000	124
Self-tapping screws	300 pc(s).	2487.000	2487.000	2487.000	2487.000	2487.000	2487.000	82
Connector gland, small	5 pc(s).	2400.500	2400.500	2400.500	2400.500	2400.500	2400.500	131

¹⁾ Must be cut to length accordingly

Rittal – The System.



Sealing frame, modular

See page 87



BUS ENCLOSURES KX – MORE OF AN **OVERVIEW**

A lid that incorporates a viewing window and opens up to an angle of 180° provides easier access and a better overview of all control components.







Access

The wide door opening angle of up to 180° gives you plenty of space to fit and replace modules quickly and easily. The large viewing window makes it easy to continuously monitor the components inside the enclosure.



Precision

The quick-release fastener works almost instantaneously. A quarter of a turn is sufficient to correctly centre the cover while locking; this ensures all-round air-tight positioning.



Reliability

The deliberately slimline enclosure edge fold provides broad, secure contact with the seamless PU foam seal and helps preserve the protection category of IP 66.



Flexibility

Enclosures can be fitted with support rails or mounting plates as required.

Protection category maintained

The seamless PU foam gasket makes it possible to maintain the protection category within a temperature range of $-20\text{ }^{\circ}\text{C}$ to $+80\text{ }^{\circ}\text{C}$ and can be overpainted if necessary.



Earthing

The PE conductor connection enables extremely quick and easy earthing, even retrospectively.

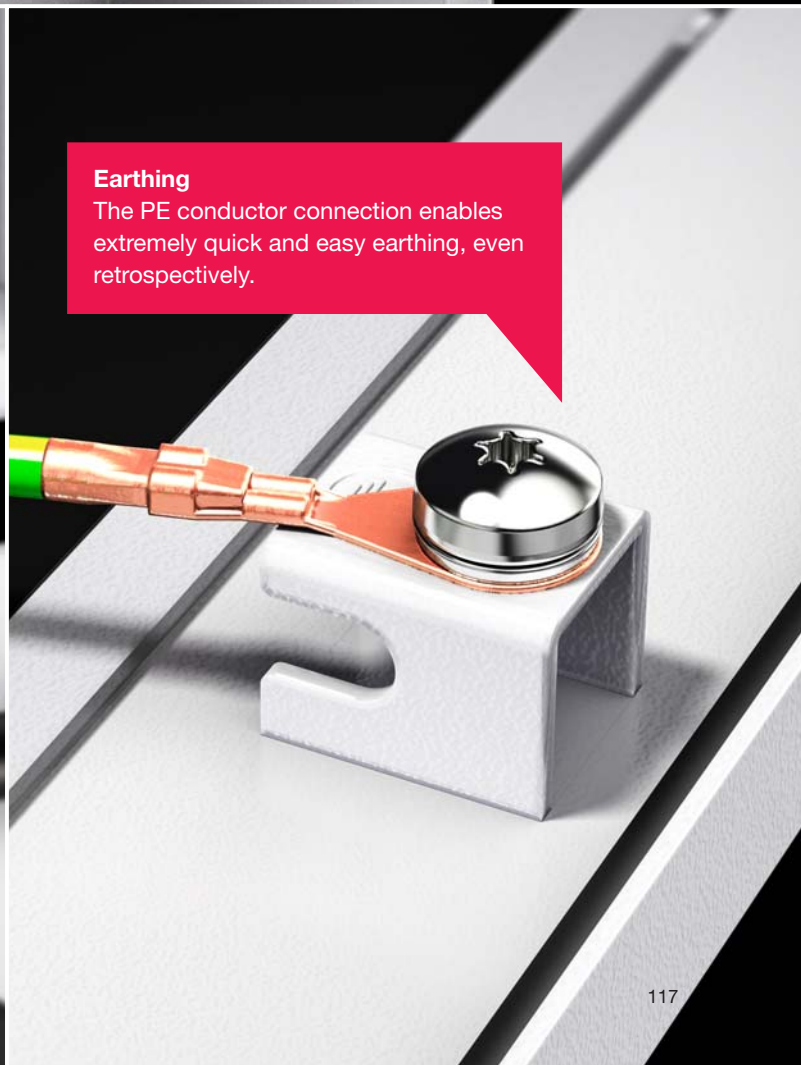

Small enclosures KX



System accessories Page 124

Material:

- Enclosure: Sheet steel
- Cover: Sheet steel, all-round foamed-in PU seal
- Viewing window: Polycarbonate, 4 mm

Surface finish:

- Enclosure and cover: Dipcoat-primed, powder-coated on the outside, textured paint

Colour:

- RAL 7035

Protection category IP to IEC 60 529:

- IP 65

Protection category NEMA:

- NEMA 12

Supply includes:

- Enclosure with hinged cover
- Viewing window in cover
- Mini cam lock

Approvals:

- UL
- cUL
- Bureau Veritas
- Lloyds Register
- DNV-GL

Further approvals can be found on the Internet.

Bus enclosures KX, sheet steel

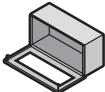
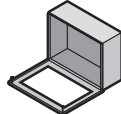
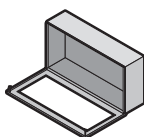
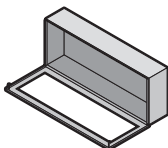
						
Width mm	Packs of	400	400	600	800	Page
Height mm		200	300	300	300	
Depth mm		155	155	155	155	
Material thickness – enclosure mm		1.25	1.25	1.25	1.25	
Material thickness – cover mm		1.25	1.25	1.25	1.25	
Model No.	1 pc(s).	1610.000	1611.000	1612.000	1613.000	
Weight kg		2.36	4.72	5.47	7.78	
Accessories						
Wall mounting bracket, for AX sheet steel, KX sheet steel	4 pc(s).	1590.010	1590.010	1590.010	1590.010	126
Pole clamp	2 pc(s).	2584.100	2584.100	2584.100	2584.100	128
Mounting plates	1 pc(s).	1564.800	1568.800	1570.800	1570.810	129
Support rails TS 35/7.5	10 pc(s).	2317.000	2317.000	2317.000	2317.000 ¹⁾	129
Support rails TS 35/15	10 pc(s).	–	–	2319.000	–	129
Mounting clip for support rails	30 pc(s).	2309.000	2309.000	2309.000	2309.000	130
Mounting bracket	4 pc(s).	4597.000	4597.000	4597.000	4597.000	81
Rail mounting bracket	20 pc(s).	2366.000	2366.000	2366.000	2366.000	81
Mounting claw for second mounting level	20 pc(s).	2309.100	2309.100	2309.100	2309.100	130
Pressure relief stopper	5 pc(s).	2459.500	2459.500	2459.500	2459.500	124
Condensate discharge	6 pc(s).	2459.000	2459.000	2459.000	2459.000	124
Baying kit	1 pc(s).	1199.100	1199.100	1199.100	1199.100	124
Earth straps	5 pc(s).	2565.050	2565.050	2565.050	2565.050	130
Self-tapping screws	300 pc(s).	2487.000	2487.000	2487.000	2487.000	82
Connector gland, small	5 pc(s).	2400.500	2400.500	2400.500	2400.500	131

¹⁾ For 800 mm wide enclosures, 2 x 400 mm wide support rails should be used

RiPanel

Plausibility-checked configuration of products and accessories



Configure online at
www.rittal.com/configurators



ACCESSORIES KX – MORE **POSSIBILITIES**

Accessory components that are perfectly coordinated with the enclosures offer more possibilities and significant savings.





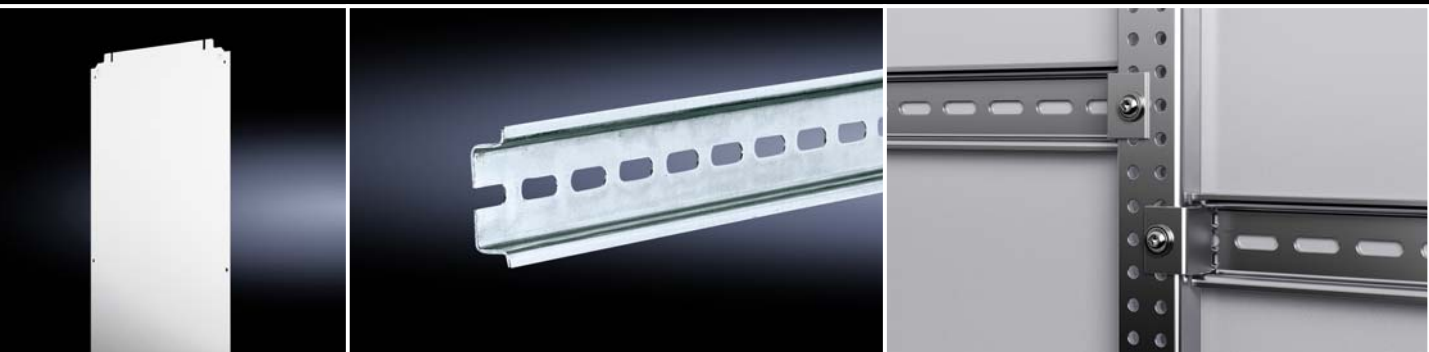
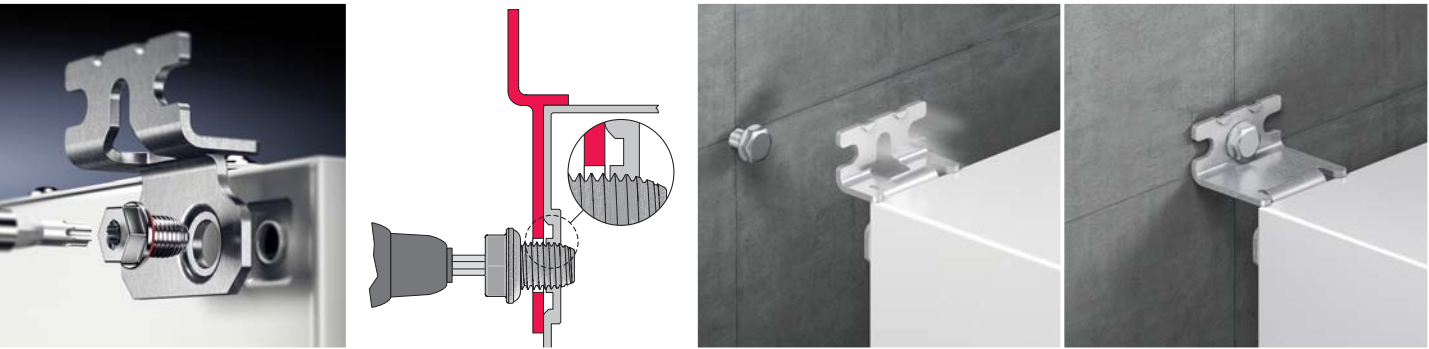

Pole clamp
The universal pole clamp makes it very easy to fasten enclosures to round or square poles without any machining.



Gland plates
Metal gland plates with metric knockouts enable quick and easy assembly of cable glands with integrated strain relief.



Wall mounting bracket, sheet steel

The new wall mounting bracket allows instant anti-twist fixing in four different positions. All sheet steel enclosures support fastening from the outside with just one self-tapping screw. The enclosure's protection category is maintained in full.

Mounting plates and support rails

There's a perfect installation option for every application – whether configuring outside the enclosure or quickly snap-mounting equipment directly in the enclosure, even if utilising the entire enclosure depth.

Earth straps

Pre-assembled earth straps of the ideal length are available in all standard cross-sections for reliable earthing. This saves a great deal of time during installation.

Cable glands

Depending on the application in question, cable glands are available in brass with nickel plating, in polyamide or as an EMC version. Integrated clamping membranes ensure reliable tightening and strain relief to protect the cables.



System accessories KX

Base/Baying



Pressure relief stopper

Especially when enclosures are exposed to changing climatic conditions, pressure differences may cause condensation to form in sealed enclosures. The integral sealing membrane in the pressure relief stopper largely prevents such pressure differences and hence eliminates condensation; additionally, it also prevents the ingress of moisture from the outside. Installed in vertical surfaces to protect against dirt.

Technical specifications:

- Air permeability up to 120 litres/hour with a pressure difference of 70 mbar
- Connection thread M12 x 1.5
- For fitting in wall thicknesses up to 4 mm

Packs of	Model No.
5 pc(s).	2459.500

Material:

- Polyamide

Colour:

- Similar to RAL 9005

Protection category IP to IEC 60 529:

- IP X8

Protection category IP to DIN 40 040-9:

- IP 69K

Supply includes:

- Lock nut



Condensate discharge

For reliable condensate discharge from the inside and protection against splashed water from the outside (labyrinth effect).

A hole diameter of 16 mm is required (with AX sheet steel, the holes are already provided in the base).

Material:

- Polyamide

Colour:

- Similar to RAL 7035

Protection category:

- Protection from splashed water, when correctly installed at the bottom

Packs of	Model No.
6 pc(s).	2459.000

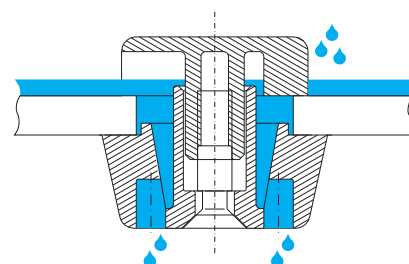

Baying kit

for AX, KX

For baying AX/KX enclosures.

The additional cut-outs are to be provided by the customer.

Special screws and nuts

- For fast, simple assembly without thread-tapping
- Compression of the seal is limited to a predefined level, to ensure a long-lasting, permanent seal between enclosures

Seal, self-adhesive

- Comprised of bayable sealing elements and corner pieces, for individual adaptation to various enclosure sizes

One pack is sufficient for a baying point up to H x D = 800 x 350 mm.

Packs of	Model No.
1 pc(s).	1199.100

Supply includes:

- Special screws and nuts
- Sealing elements, self-adhesive



System accessories KX





Lock system

Mini-comfort handle AX

for AX/AX IT with cam lock, KX with cam lock

The lock is opened by swivelling the unlocked handle. Prepared for the installation of lock inserts or for the installation of standard commercially available 40 or 45 mm profile half-cylinders, as well as lock and push-button inserts.

Other variants prepared for ASSA oval profile half-cylinder up to a maximum overall length of 26.9 mm and KESO/KABA profile half-cylinder up to a maximum overall length of 42.5 mm and a Ø of 22 mm.

				
	For lock inserts or profile half-cylinders	For padlocks and lock inserts or profile half-cylinders	Prepared for ASSA	Prepared for KESO/KABA
	Model No.			
Die-cast zinc RAL 7035	2537.100	2537.300	2537.400	2537.500
Lock inserts, type A				
7 mm square	2460.000	2460.000	-	-
8 mm square	2461.000	2461.000	-	-
7 mm triangular	2462.000	2462.000	-	-
8 mm triangular	2463.000	2463.000	-	-
Screwdriver	2464.000	2464.000	-	-
Daimler insert	2465.000	2465.000	-	-
3 mm double-bit	2466.000	2466.000	-	-
Fiat	2307.000	2307.000	-	-
6.5 mm triangular	2460.650	2460.650	-	-
Lock and push-button inserts				
Lock insert, lock no. 3524 E ¹⁾	2467.000	2467.000	-	-
Push-button insert	2468.000	2468.000	-	-
Push-button and lock insert ¹⁾	2469.000 ²⁾	2469.000 ²⁾	-	-
Profile half-cylinders				
to DIN 18 252 ³⁾	9785.040 ⁵⁾	9785.040 ⁵⁾	-	-
	9785.042 ⁴⁾	9785.042 ⁴⁾	-	-

¹⁾ With 2 keys

²⁾ Lock no. 2123; no other lock is possible

³⁾ With 3 keys for each lock insert

⁴⁾ Packs of two, simultaneous locking within the same pack, no simultaneous locking for different packs

⁵⁾ Different closures

Cover hinge

for terminal boxes KX

The cover hinge is simply screw-fastened to the enclosure protection channel and to the edge fold. The position of the installation holes is prepunched, so no need to measure and mark out.

Supply includes:

- Cover hinge
- Stoppers
- Assembly parts

Material	Packs of	Model No.
Die-cast zinc	6 pc(s).	1592.200



System accessories KX

Roof/wall mounting



Dust guard trim

for AX, KX

To protect against deposits on the upper edge of the door and between the enclosure and the door/cover. Cut the dust guard trim to length according to the enclosure width. Drill the enclosure and fit the dust guard trim using the adhesive strips and screws.

Material:

- Plastic, UV-resistant

Colour:

- Similar to RAL 7024

Supply includes:

- Assembly parts

For enclosure	Length mm	A mm	Model No.
AX	1200	21.5	2426.500
KX		21	

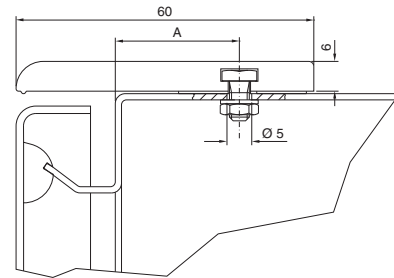

Wall mounting bracket

for AX sheet steel, KX sheet steel, AX IT, EL

For the attachment of sheet steel enclosures.

Benefits:

- Screw-fastened directly from the rear with a self-tapping screw in the enclosure eyelet

Supply includes:

- Assembly parts

Material	Wall distance mm	Packs of	Model No.
Sheet steel, zinc-plated	10	4 pc(s).	1590.010

System accessories KX

Roof/wall mounting

Wall mounting bracket

for AX sheet steel, KX sheet steel, AX IT

Ideal for convenient one-person assembly of wall-mounted enclosures, even in confined spaces.

Benefits:

- Screw-fastened directly from the rear with a self-tapping screw in the enclosure eyelet
- The wall-mounted bracket 2508.020 is equipped with an additional location contour. Simply locate onto a screw in the wall
- Different mounting positions allow the wall mounting bracket to be tailored to local conditions on site
- If necessary, the support may be finished with a stylish cover cap
- Additional option of attaching with a nut for dynamic applications

Supply includes:

- Wall mounting bracket
- Cover cap
- Assembly parts

Material	Wall distance mm	Packs of	Model No.
Sheet steel, zinc-plated	20	4 pc(s).	2508.020
	40	4 pc(s).	2503.020

Sample applications

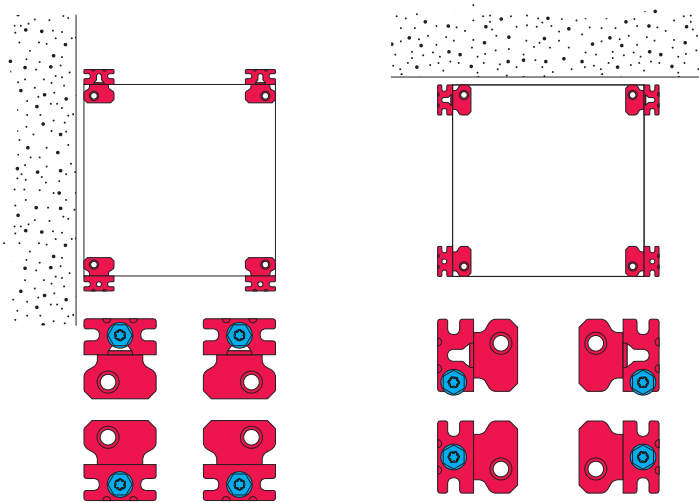

Attachment with self-tapping screw

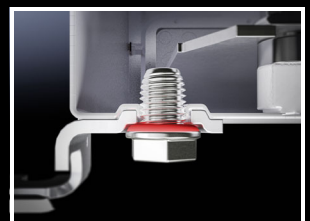
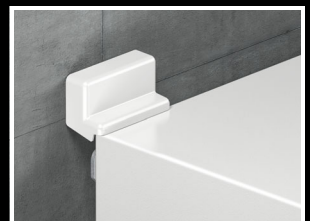
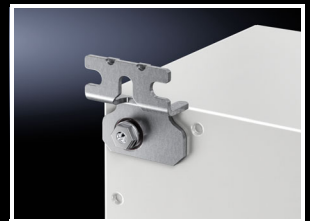
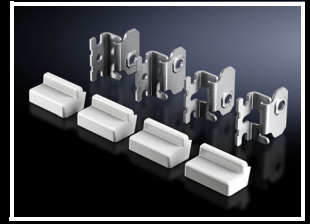
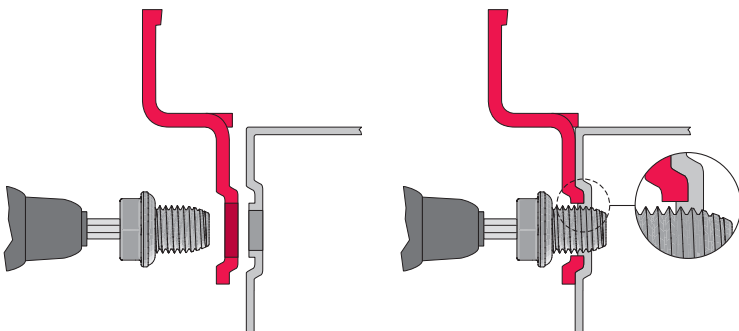

System accessories KX

Roof/wall mounting

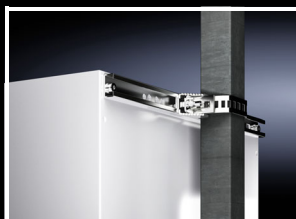

Pole clamp

for AX, KX, AX plastic, AX IT

For reliable, convenient fastening to round or square poles.

For pole diameter / size:

- Ø from 40 to 170 mm
- □ from 50 to 150 mm

Material:

- Mounting angles, clamping section: Sheet steel
- Clamping strap: Stainless steel 1.4301 (AISI 304)

Surface finish:

- Mounting angle, clamping section: Zinc-plated

Supply includes:

- 2 mounting angles, 600 mm long
- 4 clamping sections
- 2 clamping straps
- 4 clamping brackets
- Assembly parts

Packs of	Model No.
2 pc(s).	2584.100

Note:

- The pole clamp cannot be used in conjunction with a protective roof for AX.

System accessories KX

Interior installation

Mounting plates

for terminal boxes KX, bus enclosures KX

For component installation outside of the enclosure. Assembly screws included as accessories with the enclosure.

Material:

– Sheet steel, 2 mm

Surface finish:

– Zinc-plated



Accessories:

– Self-tapping screws 2487.000, see page 82



Possible alternative:

– Support rails, see page 129



For size mm	For Model No.	Model No.
150 x 150	1500.000, 1514.000, 1560.000, 1564.000	1560.800
200 x 150	1528.000, 1529.000	1575.800
300 x 150	1501.000, 1515.000, 1530.000, 1561.000	1561.800
400 x 150	1589.000	1576.800
200 x 200	1502.000, 1516.000, 1562.000, 1565.000	1562.800
300 x 200	1503.000, 1517.000, 1531.000, 1563.000, 1566.000	1563.800
400 x 200	1504.000, 1518.000, 1532.000, 1568.000, 1585.000, 1610.000	1564.800
500 x 200	1505.000, 1533.000	1565.800
600 x 200	1506.000, 1586.000	1566.800
800 x 200	1527.000	1574.800
300 x 300	1507.000, 1535.000, 1567.000	1567.800
400 x 300	1508.000, 1536.000, 1569.000, 1611.000	1568.800
500 x 300	1509.000, 1537.000	1569.800
600 x 300	1510.000, 1538.000, 1612.000	1570.800
800 x 300	1613.000	1570.810
400 x 400	1511.000, 1539.000	1571.800
600 x 400	1512.000, 1540.000	1572.800
800 x 400	1513.000, 1541.000	1573.800

Support rails TS 35/7.5 and TS 35/15

to EN 60 715 for AX, KX

Length sized to the enclosure width.

For enclosure width mm	Support rails length mm	Design	Packs of	Model No.
150	137	TS 35/7.5	10 pc(s).	2314.000
200	187		10 pc(s).	2315.000
300	287		10 pc(s).	2316.000
400	387		10 pc(s).	2317.000
500	487	TS 35/15	10 pc(s).	2318.000
600	587		10 pc(s).	2319.000



Support rails

to EN 60 715

Standard length: 2 m

Design	Length	Packs of	Model No.
TS 35/15	2 m	6 pc(s).	2313.150
TS 35/7.5	2 m	6 pc(s).	2313.750

System accessories KX

Interior installation



Mounting clip

For fast, secure attachment of:

- Cable ducts
- Mounting plates
- Mounting angles

on support rail TS 35/7.5 and 35/15 to EN 60 715. Simply pre-assemble the mounting clip on the part to be installed, then snap into position on the support rail.

Packs of	Model No.
30 pc(s).	2309.000

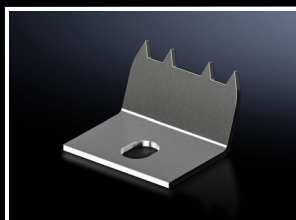

Mounting claw for second mounting level

for terminal boxes KX, bus enclosures KX

For fixing top hat rails directly onto the rear panel of KX terminal boxes and KX bus enclosures. Creates an additional mounting level with an extra 10 mm of installation depth without having to machine the enclosure.

Packs of	Model No.
20 pc(s).	2309.100

Accessories:

- Support rails TS 35/7.5 to EN 60 715, see page 129

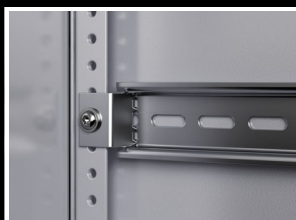

Spacer bracket for KX contact hazard protection cover

For installation in KX terminal boxes with a depth of 120 mm

For mounting contact hazard protection cover plates.

Material:

- Sheet steel

Surface finish:

- Zinc-plated

For enclosure depth mm	Packs of	Model No.
120	4 pc(s).	2309.010

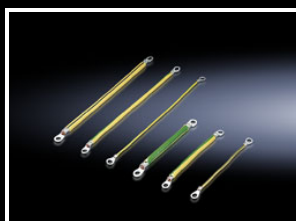
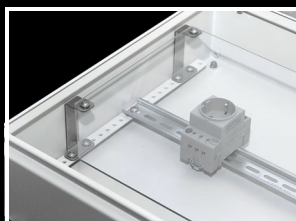

Earth straps

For configuring a reliable earthing connection with perfect contact

- With ring terminals to match the earthing screws
- Length-optimised and ready to install

Connection	Cross-section mm ²	Length mm	Packs of	Model No.
M6 – M6	10	200	5 pc(s).	2565.100
M6 – M6	10	350	5 pc(s).	2565.050

Enclosure	Connection option		
	Door/cover	Enclosure	Mounting plate
KX	M6	M6	M6

System accessories KX

Cable management

Metal gland plates

with metric knockouts, for KX

Simply knock out the holes for the cable glands using a screwdriver.

Material:

– Sheet steel

Colour:

– RAL 7035

Protection category IP to IEC 60 529:

– IP 55 if installed correctly

	Diameter	Packs of	Model No.
	M20	1 pc(s).	1581.200



Accessories:

– Cable glands made from polyamide or brass, see page 132.

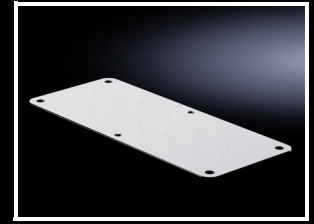
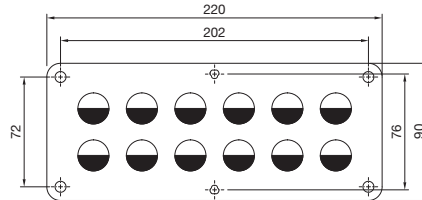

Connector gland, small

For pre-assembled cables with connectors. For use with material thickness of up to 4 mm. Strain relief of the pre-assembled cables can be achieved with cable ties.

Material:

– Plastic

Colour:

– RAL 9005

Protection category IP to IEC 60 529:

– IP 65 if installed correctly

Supply includes:

– Assembly parts

To fit	Packs of	Model No.
2 cables Ø 6 – 8 mm	1 pc(s).	2400.300
3 cables Ø 4 – 6 mm	5 pc(s).	2400.500

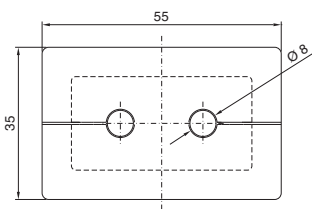
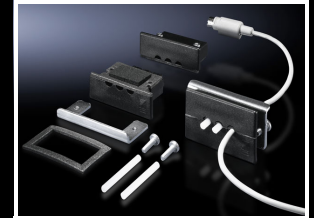

2400.300

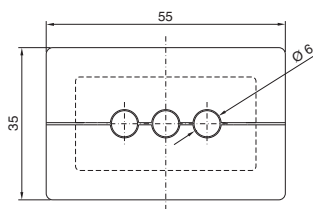

2400.500

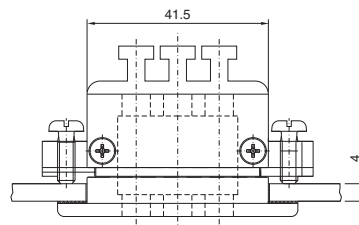
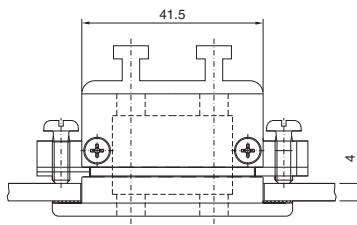
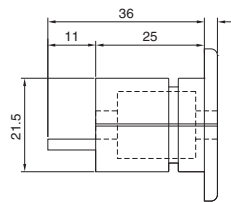

Mounting cut-out

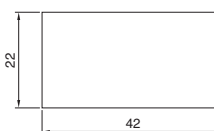

System accessories KX

Cable glands



Cable gland, brass

Benefits:

- Because the gland and lock nut are sold together in a single pack, this saves additional ordering and storage
- Clamping membranes for even tightening and strain relief to protect the cables

Material:

- Brass
- Seal: CR/NBR

Surface finish:

- Nickel-plated

Protection category IP to IEC 60 529:

- IP 68 (5 bar, 30 min.)

Approvals:

- VDE, UR, cUR

Size	Packs of	Model No.
M12 x 1.5	15 pc(s).	2411.801
M16 x 1.5	15 pc(s).	2411.811
M20 x 1.5	10 pc(s).	2411.821
M25 x 1.5	10 pc(s).	2411.831
M32 x 1.5	5 pc(s).	2411.841
M40 x 1.5	4 pc(s).	2411.851
M50 x 1.5	2 pc(s).	2411.861
M63 x 1.5	1 pc(s).	2411.871



Cable gland, polyamide

Benefits:

- Because the gland and lock nut are sold together in a single pack, this saves additional ordering and storage
- Clamping membranes for even tightening and strain relief to protect the cables

Material:

- Polyamide 6
- Seal: CR/NBR

Colour:

- RAL 7035

Protection category IP to IEC 60 529:

- IP 68 (5 bar, 30 min.)

Approvals:

- VDE, UL, cUL, CSA, CSAus

Size	Packs of	Model No.
M12 x 1.5	50 pc(s).	2411.601
M16 x 1.5	50 pc(s).	2411.611
M20 x 1.5	50 pc(s).	2411.621
M25 x 1.5	25 pc(s).	2411.631
M32 x 1.5	15 pc(s).	2411.641
M40 x 1.5	5 pc(s).	2411.651
M50 x 1.5	5 pc(s).	2411.661
M63 x 1.5	3 pc(s).	2411.671



EMC cable gland

The cable sheathing may optionally be interrupted at the contact point or removed completely inside the enclosure.

The cable shielding in the enclosure is retained.

The supplied lock nut cuts automatically into the paint when screwed onto spray-finished enclosure surfaces, thus creating a conductive connection.

The supplied lock nut cuts automatically into the paint when screwed onto spray-finished enclosure surfaces, thus creating a conductive connection.

Protection category IP to IEC 60 529:

- IP 68

Material:

- Brass
- Seal: CR/NBR

Surface finish:

- Nickel-plated

Approvals:

- VDE, UR, cUR

Cable glands, metric

Size	Cable diameter mm	Minimum shield diameter ¹⁾ mm	Packs of	Model No.
M16	4.5 – 10	3	5 pc(s).	2843.160
M20	6 – 12	5	5 pc(s).	2843.200
M25	11 – 17	8	5 pc(s).	2843.250
M32	15 – 21	10	1 pc(s).	2843.320
M40	19 – 28	15	1 pc(s).	2843.400
M50	27 – 38	19	1 pc(s).	2843.500
M63	34 – 44	30	1 pc(s).	2843.630

¹⁾ Minimum shield diameter = cable diameter minus cable sheathing

The 3-phase coating procedure

Coating procedure	Technical properties	Technical specifications	
Degreasing, nanoceramic pretreatment, rinsing	Used as corrosion protection and to improve paint adhesion.	Nanoceramic conversion layer	
Interior/exterior: Anodic dipcoat priming	Even layer formation on all surfaces, edges and in cavities, which produces a high level of corrosion protection even at the assembly stage. The primer is readily overpainted and free from heavy metals, chromate and silicone.	Erichsen cupping test to DIN EN ISO 1520	≥ 4 mm
		Buchholz hardness to DIN EN ISO 2815	≥ 80
		Cross cutting to DIN EN ISO 2409	Gt 0
Stove enamelling			
Exterior: Textured powder coating	Powder-coating is distinguished by a high level of mechanical resistance, excellent corrosion protection, good resistance to chemicals and temperature, and its facility for decontamination. The powder coating is readily overpainted and is free from heavy metals, chromate and silicone.	Erichsen cupping test to DIN EN ISO 1520	≥ 3.5 mm
		Buchholz hardness to DIN EN ISO 2815	≥ 80
		Cross cutting to DIN EN ISO 2409	Gt 0
		Salt spray test to DIN EN ISO 9227 NSS	Test period: 168 hours
		Condensate test to DIN EN ISO 6270-2 CH	Test period: 500 hours
		Condensate test to DIN EN ISO 6270-2 AHT	Test period: 20 cycles
Stove enamelling			

The coating is resistant to:

- Mineral oils
- Lubricants
- Machine emulsions
- Alcohol-based solvents (briefly, e.g. during cleaning)
- Weak acids and alkalines

Primer or powder coating suitable for overpainting

After careful cleaning of the surface, the standard coating may be overpainted with

- DD gloss paints
- Single and dual-component gloss paints
- Car repair paints
- Powder paints
- Water-based paints

If in doubt, perform a compatibility test. Always follow the paint manufacturer's instructions. When overpainting, take care not to exceed 180 °C and a baking time of 15 minutes.

Outdoor use of enclosures

In order to guarantee satisfactory long-term function of enclosures in outdoor use, the relevant environmental factors must be taken into account.

These include:

- UV radiation, the corrosive action of air pollution, rain, icing, snow, wind or other factors in special climatic conditions.

Condensation inside the enclosure

Condensation must be prevented by means of appropriate measures, e.g. by venting or heating the enclosure.

Protection category

The enclosure may be exposed to extreme weather conditions during outdoor use.

Long periods of rain, snow, ice, high winds and temperature fluctuations place particularly high demands on the enclosure sealing. The protection category IP X3 as envisaged for external weather conditions in DIN VDE 0100, part 737, point 5.2 is often insufficient to provide permanent protection for electrical equipment.

Protection categories to IEC 60 529 (EN 60 529)

The IP protection category is characterised by 2 numerals.

Example of a protection category, e.g. IP 43:

Code letters	
IP	
First numeral	Second numeral
4	3

Degrees of protection for protection against contact and foreign bodies: First numeral			Degrees of protection for protection against water: Second numeral		
First numeral	Degree of protection		Second numeral	Degree of protection	
	Description	Explanation		Description	Explanation
1	Protected against solid foreign objects with a diameter of 50 mm and greater	The object probe, a sphere 50 mm in diameter, must not penetrate fully. ¹⁾	1	Protected against vertically falling water drops	Vertically falling drops shall have no harmful effects.
2	Protected against solid foreign objects with a diameter of 12.5 mm and greater	The object probe, a sphere 12.5 mm in diameter, must not penetrate fully. ¹⁾ The articulated test finger may penetrate up to its length of 80 mm, but adequate distance from hazardous parts must be adhered to.	2	Protected against vertically falling water drops when the enclosure is tilted up to 15°	Vertically falling drops shall not have any harmful effects when the enclosure is tilted up to 15° on either side of the vertical.
3	Protected against solid foreign objects with a diameter of 2.5 mm and greater	The object probe, a sphere 2.5 mm in diameter, must not penetrate at all ¹⁾ .	3	Protected against sprayed water	Water sprayed at an angle of up to 60° on either side of the vertical shall have no harmful effects.
4	Protected against solid foreign objects with a diameter of 1.0 mm and greater	The object probe, a sphere 1.0 mm in diameter, must not penetrate at all ¹⁾ .	4	Protected against splashed water	Water splashed on the enclosure from any direction shall have no harmful effects.
5	Dust-protected	The ingress of dust is not fully prevented, but dust shall not enter to such an extent as to impair satisfactory operation of the device or safety.	5	Protected against water jets	Water directed at the enclosure from any direction in a jet shall have no harmful effects.
6	Dust-tight	No ingress of dust at a partial vacuum of 20 mbar inside the enclosure.	6	Protected against powerful water jets	Water directed at the enclosure from every direction in a powerful jet shall have no harmful effects.
			7	Protected against temporary immersion in water	Water must not ingress to such an extent as to cause harmful effects when the enclosure is temporarily immersed in water under standardised pressure and time conditions.
			8	Protected against continuous immersion in water	Ingress of water in quantities causing harmful effects shall not be possible when the enclosure is continuously immersed in water under conditions to be agreed between the manufacturer and the user. However, the conditions must be more difficult than for numeral 7.
			9	Protected against high-pressure and high-temperature water jets	Water projected at high pressure and high temperature against the enclosure from any direction shall not have harmful effects.

¹⁾ The full diameter of the object probe must not pass through an opening of the enclosure.

NEMA

The **N**ational **E**lectrical **M**anufacturers **A**ssociation (NEMA) is a standards organisation in Washington, USA, which publishes a number of technical standards but does not test or certify products itself.

The following NEMA classification outlines the protection of individuals from accidental contact with equipment and the protection of an enclosure from external factors.

Further information on protection categories may be found on the Internet at: www.rittal.com

UL/NEMA Type	Intended use and description
1	Enclosures for use predominantly indoors Protection against the penetration of foreign bodies
3	Enclosures for use predominantly outdoors Protection from rain, hail, dust, icing and the damage caused by icing
3R	Enclosures for use predominantly outdoors Protection from rain, hail, icing and the damage caused by icing
3S	Enclosures for use predominantly outdoors Protection from rain, hail and dust External mechanisms remain usable despite being coated in ice
4	Enclosures for indoor or outdoor use Protection against rain, foreign bodies, splashed water and hosed water and against damage caused by icing on the exterior of the enclosure
4X	Enclosures for indoor or outdoor use Protection against rain, foreign bodies, splashed water and hosed water and against damage caused by icing on the exterior of the enclosure Increased protection from corrosion.
12, 12K	Enclosures for use predominantly indoors Protection against dust deposits, foreign bodies and non-corrosive dripping liquids
13	Enclosures for use predominantly indoors Protection against dust deposits, sprayed water, oil, and non-corrosive coolants

The UL/NEMA classifications are not directly comparable with IP protection categories, since both the test conditions and the evaluation of the test results are different

Approvals and permits

Product certifications and approvals are pivotal to the global acceptance of industrial products.

Rittal products meet the highest internationally recognised quality yardsticks. All components are subjected to the most stringent testing in accordance with international standards and regulations.

The consistently high product quality is ensured by a comprehensive quality management system. Regular production inspections by external test institutes also guarantee compliance with global standards.

A precise allocation of products to marks of conformity can be found on our product and service pages on the Internet at: www.rittal.com

PE conductor connection

The PE conductor connection must be designed by the manufacturer of switchgear in accordance with the relevant VDE and/or local regulations.

The enclosure packs generally contain earthing materials (screws, nuts, washers). The assembly instructions contain recommendations on installing a PE conductor. The pre-assembled earth straps, available as accessories in various cross-sections and lengths, are intended to make assembly of a PE conductor easier.

Further information can be found in our technical documentation "PE conductor connection, current carrying capacity".

List of Model Numbers

Model No.	Page	Model No.	Page	Model No.	Page	Model No.	Page
1031.000	34	1535.000	103	2351.000	80	2486.600	82
1033.000	33	1536.000	103	2352.000	80	2487.000	82
1034.000	33	1537.000	104	2353.000	80	2493.500	67
1037.000	34	1538.000	104	2354.000	80	2500.100	94
1038.000	34	1539.000	103	2355.000	80	2500.104	94
1039.000	35	1540.000	104	2356.000	80	2500.110	94
1045.000	34	1541.000	104	2357.000	80	2500.114	94
1050.000	35	1545.000	111	2358.000	80	2500.420	95
1054.000	36	1546.000	111	2359.000	80	2500.450	95
1055.000	38	1547.000	111	2360.000	80	2500.460	95
1057.000	35	1548.000	112	2361.010	71	2500.470	95
1058.000	36	1549.000	112	2362.010	71	2500.490	95
1059.000	36	1550.000	112	2363.010	71	2500.520	95
1060.000	35	1551.000	111	2365.000	81	2500.550	95
1073.000	37	1552.000	111	2366.000	81	2503.020	73, 127
1076.000	36	1553.000	112	2393.210	75, 77	2504.000	82
1077.000	37	1554.000	112	2393.250	75, 77	2505.510	74
1090.000	37	1555.000	112	2393.300	75, 77	2508.020	73, 127
1091.000	37	1556.000	112	2393.350	75, 77	2509.010	72
1100.000	38	1557.000	112	2393.400	75, 77	2510.000	70
1110.000	39	1560.800	129	2400.300	92, 131	2512.000	70
1114.000	39	1561.800	129	2400.500	92, 131	2513.000	70
1115.000	39	1562.800	129	2411.601	93, 132	2514.000	70
1116.000	39	1563.800	129	2411.611	93, 132	2515.000	70
1130.000	39	1564.800	129	2411.621	93, 132	2515.200	70
1180.000	38	1565.800	129	2411.631	93, 132	2515.300	70
1181.000	38	1566.800	129	2411.641	93, 132	2515.400	70
1199.100	62, 124	1567.800	129	2411.651	93, 132	2519.010	70
1213.000	39	1568.800	129	2411.661	93, 132	2521.000	68
1214.000	39	1569.800	129	2411.671	93, 132	2531.000	68
1260.000	37	1570.800	129	2411.801	93, 132	2532.000	68
1261.000	37	1570.810	129	2411.811	93, 132	2537.100	66, 125
1280.000	38	1571.800	129	2411.821	93, 132	2537.300	66, 125
1281.000	38	1572.800	129	2411.831	93, 132	2545.000	68
1338.000	34	1573.800	129	2411.841	93, 132	2546.000	68
1339.000	35	1574.000	113	2411.851	93, 132	2547.000	68
1350.000	35	1574.800	129	2411.861	93, 132	2548.000	68
1360.000	36	1575.000	113	2411.871	93, 132	2549.000	68
1376.000	36	1575.800	129	2416.000	68	2549.500	68
1380.000	34	1576.000	113	2418.000	68	2561.200	89
1500.000	101	1576.800	129	2419.000	68	2561.300	90
1501.000	101	1577.000	113	2426.500	71, 126	2562.200	89
1502.000	101	1578.000	113	2435.100	65	2562.300	90
1503.000	101	1579.000	113	2435.400	65	2563.200	89
1504.000	101	1581.200	131	2446.000	69	2563.300	90
1505.000	101	1589.000	101	2449.010	68	2564.000	84
1506.000	102	1590.010	72, 126	2459.000	62, 124	2564.200	89
1507.000	101	1592.200	125	2459.500	62, 124	2564.300	90
1508.000	101	1610.000	118	2460.000	67	2565.000	84
1509.000	102	1611.000	118	2460.650	67	2565.050	130
1510.000	102	1612.000	118	2461.000	67	2565.100	130
1511.000	101	1613.000	118	2462.000	67	2565.120	84
1512.000	102	2034.010	83	2463.000	67	2565.200	89
1513.000	102	2307.000	67	2464.000	67	2565.300	90
1514.000	100	2308.000	68	2465.000	67	2565.400	92
1515.000	100	2309.000	81, 130	2466.000	67	2566.000	84
1516.000	100	2309.100	130	2467.000	66	2566.200	89
1517.000	100	2313.150	80, 129	2468.000	66	2566.300	90
1518.000	100	2313.750	80, 129	2469.000	66	2566.400	92
1527.000	102	2314.000	80, 129	2472.010	71	2567.000	84
1528.000	100	2315.000	80, 129	2473.010	71	2567.200	89
1529.000	101	2316.000	80, 129	2474.010	71	2567.400	92
1530.000	103	2317.000	80, 129	2475.010	71	2568.000	84
1531.000	103	2318.000	80, 129	2476.010	71	2569.000	84
1532.000	103	2319.000	80, 129	2476.100	67	2571.100	91
1533.000	103	2350.000	80	2486.400	82	2572.100	91

List of Model Numbers

Model No.	Page	Model No.	Page	Model No.	Page
2573.100	91	2820.410	61	9666.754	85
2574.100	91	2820.420	61	9666.756	85
2575.100	91	2843.160	93, 132	9666.757	85
2576.100	91	2843.200	93, 132	9666.801	85
2577.100	91	2843.250	93, 132	9666.811	85
2580.000	87	2843.320	93, 132	9666.821	85
2580.003	87	2843.400	93, 132	9666.831	85
2580.004	87	2843.500	93, 132	9666.841	85
2580.005	87	2843.630	93, 132	9666.851	85
2580.006	87	4597.000	81	9785.040	66
2580.007	87	4599.100	69	9785.042	66
2580.008	87	4599.200	69	9792.055	71
2580.009	87	4694.000	69	9792.065	71
2580.010	87	4695.000	69	9792.075	71
2580.011	87	4696.000	69		
2580.012	87	4697.000	69		
2580.013	87	6205.100	81		
2580.014	87	6315.150	45		
2580.100	87	6315.250	45		
2580.115	87	6315.350	45		
2580.116	87	6315.450	45		
2580.117	87	6315.650	45		
2580.118	87	6320.050	45		
2580.119	87	6320.350	45		
2580.120	87	6320.450	45		
2580.121	87	6320.550	45		
2580.122	87	6320.650	45		
2580.123	87	6321.050	46		
2580.124	87	7641.350	40		
2580.125	87	7643.350	40		
2582.100	87	7645.350	40		
2582.200	87	7646.400	40		
2582.400	87	8617.100	79		
2582.600	87	8617.110	79		
2583.010	74	8617.120	79		
2583.080	87	8617.130	79		
2583.100	87	8617.140	79		
2583.120	88	8617.150	79		
2584.100	74, 128	8617.160	79		
2730.010	63	8617.170	79		
2731.010	63	8617.800	79		
2732.010	63	8617.810	79		
2733.010	63	8617.820	79		
2740.010	63	8617.830	79		
2741.010	63	8619.400	80		
2742.010	63	8619.410	80		
2743.010	63	8619.420	80		
2744.010	63	8619.430	80		
2745.010	63	8619.440	80		
2746.010	63	8619.500	83		
2749.100	64	8619.510	83		
2760.010	63	8619.520	83		
2761.010	63	8619.530	83		
2762.010	63	8619.600	83		
2763.010	63	8619.610	83		
2817.000	61	8619.700	78		
2820.061	60	8619.710	69, 78		
2820.062	60	8619.720	69, 78		
2820.081	60	8619.730	69, 78		
2820.082	60	8619.750	78		
2820.101	60	8619.760	78		
2820.102	60	8619.770	78		
2820.121	60	8619.780	78		
2820.122	60	8619.790	78		
2820.310	61	8800.770	82		
2820.320	61	9666.753	85		

A

Attachment	
– Pole clamp, AX, AX IT	74, 128
AX IT	
– IT wall-mounted enclosures	40

B

Base mounting	
– Base mounting plate for base/plinth VX, base/plinth AX, base/plinth, complete	61
Base/plinth corner pieces with base/plinth trim panels, front and rear	
– Sheet steel	60
Base/plinth trim panels	
– side, sheet steel	61
Baying kit	
– for AX, KX	62, 124
Bus enclosures KX	
– Sheet steel	118

C

Cable clamp	
– for cable clamp rails	80
Cable clamp rail	
– Right angle section	80
Cable gland	
– brass	93, 132
Cable gland plates	
– Metal	91, 131
– Plastic	89, 90
Cable glands	
– EMC	93, 132
– Polyamide	93, 132
Cam locks	
– for operating panel	64
Clamp rail for cables	80
Comfort handle	
– AX	65
– AX Mini	66, 125
Compact enclosures AX	
– Basic enclosure AX, sheet steel	32 – 39
– Operating housing AX for desktop TFT up to 24"	46
– Operating housings AX with handle strips	44, 45
– with support arm connection and handle strips	44, 45
– with support arm connection and TFT holder for desktop TFT up to 24"	46
Condensate discharge	62, 124
Connection accessories	
– for LED system light	95
Connector gland	92, 131
Cover hinge	
– for terminal boxes KX	125

D

Door stay AX	70
Door-operated switch	
– for LED system light	95
Dust guard trim	
– for AX, KX	71, 126

E

Earth straps	84, 130
E-Box KX	
– Sheet steel	110 – 113
EMC	
– Cable gland	93, 132
Enclosure	
– Key	68
Eyebolts	
– for AX	72

G

Gas pressurised spring	
– for viewing window	63
Gland plate	
– Metal	91
– Plastic gland plate, modular	89
– with foam rubber cable clamp strip	92
Gland plates	
– Metal	131
– Plastic	90
– with membranes, plastic	90

H

Handle	
– Comfort handle AX	65
– Mini-comfort handle AX	66, 125
Hinge 180°	68
Horizontally hinged FT stay	63

I

Inlay for plastic gland plate, modular and sealing frame, modular	87
Installation kit	
– for swing frame, small	83
Installation kit ISV	
– for AX	85
Interior installation	
– Rail for AX	77
Isolator cap for screw head	82
IT enclosures	
– Wall-mounted enclosures AX IT	40

L

LED system light	94
– Accessories	95
Lights	
– LED system light	94
Lock cover	67
Lock inserts	
– for AX with cam lock	67
– for AX with locking rod	67
– for comfort handle AX	66, 67
– for mini-comfort handle AX	66, 67
Locking clip for seal inserts	88

M

Membrane gland plate	90
Metal gland plate	91, 131
Metal multi-tooth screw	82
Mini-comfort handle AX	66, 125
Monitor housings AX	
– for desktop TFT up to 24"	46
– with handle strips	44, 45
Mounting angles ISV	
– for AX	85
Mounting bracket	81
– for interior installation	81
Mounting claw for second mounting level	130
Mounting clip	130
Mounting clip for support rails	81
Mounting kit	
– for LED system light	95
– Magnet	95
Mounting kit AX	
– for installation kit for swing frame, small	83
Mounting plates	
– for terminal boxes KX, bus enclosures KX	129
Mounting rail	
– Interior installation AX	77
Multiple lock	67

O

Operating housings AX	
– for desktop TFT up to 24"	46
– with handle strips	44, 45
Operating panel	63
Outdoor housing	71

P

Plastic	
– Gland plate	89, 90
Plastic cable gland, modular and sealing frame, modular	86
Plate	
– for base mounting	61
Pole clamp	
– for AX, KX, AX plastic	128
– for AX, KX, AX plastic, AX IT	74
Pressure relief stopper	62, 124
Protective roof	
– for AX	71
Punched section with mounting flange, 14 x 39 mm	
– for AX	69, 78
Punched sections with mounting flanges, 23 x 64 mm	79

R

Rail mounting bracket	81
Rails	
– for interior installation AX	77

S

Safety lock	68
Screws	82
Seal inserts for plastic gland plate, modular and sealing frame, modular	87
Sealing frame, modular	87
Self-tapping screw	82
Sheet steel	
– Bus enclosures KX	118
– Compact enclosures AX	32 – 39
– E-Box KX	110 – 113
– Operating housings AX with handle strips	44, 45
– Terminal boxes KX, with gland plate	103, 104
– Terminal boxes KX, without gland plate	100 – 102
Small enclosures KX	
– Bus enclosures KX, sheet steel	118
– E-Box KX, sheet steel	110
– Terminal boxes KX, with gland plate	103, 104
– Terminal boxes KX, without gland plate	100 – 102
Spacer bracket for KX contact hazard protection cover	130
Spare key	68
Stay	
– for viewing window	63
Storage box	69
Straps, earth straps	84, 130
Support rail	
– 48 x 26 mm	79
Support rails	80, 129
Support strips	
– for AX with cam lock	69, 78
Swing frame	
– Small	83
System lights	94

T

Technical information	133 – 135
Terminal boxes KX	
– Cover hinge	125
– Sheet steel, with gland plate	103, 104
– Sheet steel, without gland plate	100 – 102
TFT	
– Operating housing AX for desktop TFT up to 24"	46

V

Viewing window	63
– for operating panel	64

W

Wall angle	
– for AX, KX, AX IT	74
Wall mounting bracket	
– for AX sheet steel, KX sheet steel, AX IT, EL	72, 73, 126, 127
Wall-mounted enclosures AX IT	40
Window	
– Viewing window	63
– Viewing window for operating panel	64
Wiring plan pockets	
– Plastic	70
– Sheet steel, width-variable	70
– with transparent pouch	70

We reserve the right to further developments and technical modifications of our products. Such modifications, along with errors and printing errata, shall not constitute grounds for compensation. We refer customers to our Terms of Sale and Delivery.

Rittal – The System.

Faster – better – everywhere.

- Enclosures
- Power Distribution
- Climate Control
- IT Infrastructure
- Software & Services

You can find the contact details of all Rittal companies throughout the world here.



www.rittal.com/contact

XWWW00182EN201

ENCLOSURES

POWER DISTRIBUTION

CLIMATE CONTROL

IT INFRASTRUCTURE

SOFTWARE & SERVICES



FRIEDHELM LOH GROUP