



Current inputs

Primary current I _{pn} (/5)	A	40
Operational frequency	min	Hz 50
	max	Hz 60
Secondary output current	A	5
Overload withstand I _{pn}	%	120
Burden	cl. 3	VA 1.25

Insulations

Rated insulation voltage U _i IEC/EN	V	720
IEC rated short-time thermal current I _{th}	I _{th} for s	40...60
IEC rated dynamic current I _{dyn}	I _{th} for s	2.5
Insulation dry type		Class E

Mechanical features

Terminals type		Screw
Fixing		DIN rail or by Screw
Weight	g	200

Ambient conditions

Temperature	Operating temperature	
	min	°C -25
	max	°C +50
	Storage temperature	
	min	°C -40
	max	°C +80
Relative humidity	%	90
Protection degree		IP30

Dimensions

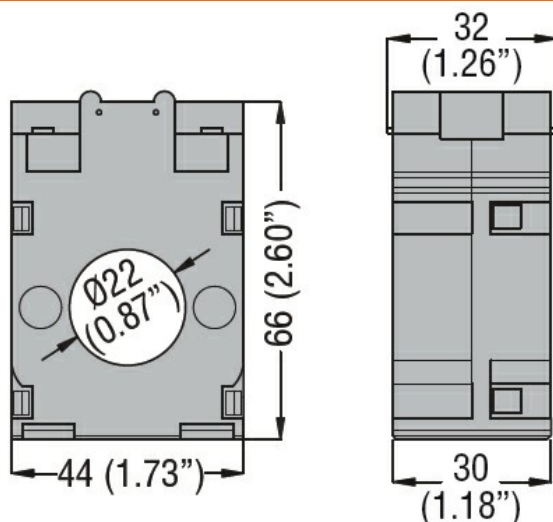

Certifications and compliance

Certifications

IEC/EN/BS 61869-1

IEC/EN/BS 61869-2

Compliance

EAC

ETIM classification

EC000066 - Power contactor, AC switching