

LC-P1242P

DIMENSIONS (MM)



Contents indicated (including the recycle marking, etc.) are subject to change without notice.

FOR STANDBY POWER SUPPLIES.
EXPECTED TRICKLE DESIGN LIFE: 10 - 12 YEARS AT 20°C
ACCORDING TO EUROBAT.

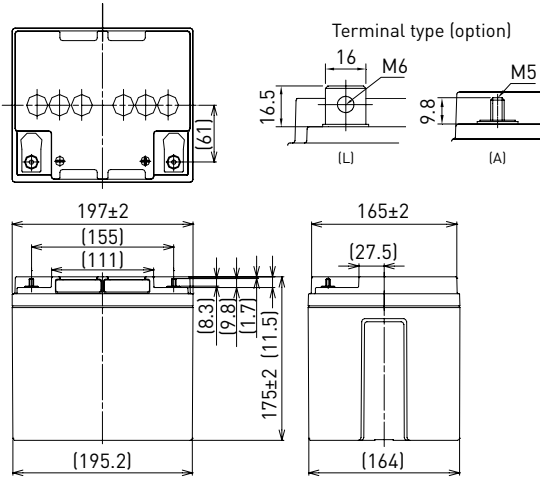

Battery case resin: flame retardant (UL94 V-0)

| SPECIFICATIONS | | |
|---|--------------------------------|-------------|
| Name | LC-P1242P/AP | |
| Nominal voltage | 12V | |
| Nominal capacity (20 hour rate) | 42Ah | |
| Dimensions | Length | 197mm |
| | Width | 165mm |
| | Height | 175mm/180mm |
| Approx. mass | 13.5kg | |
| Terminal | M6 bolt/nut & M5 threaded post | |
| Capacity (25°C) | 20 hour rate | 42Ah |
| | 10 hour rate | 40Ah |
| | 3 hour rate | 32Ah |
| | 1 hour rate | 26Ah |
| Impedance | Fully charged battery (25°C) | 10mΩ |
| | | |
| Temperature dependency of capacity (20 hour rate) | 40°C | 102% |
| | 25°C | 100% |
| | 0°C | 85% |
| | -15°C | 65% |
| Self-discharge (25°C) | After 3 month | 91% |
| | After 6 month | 82% |
| | After 12 month | 64% |

DURATION OF DISCHARGE VS. DISCHARGE CURRENT

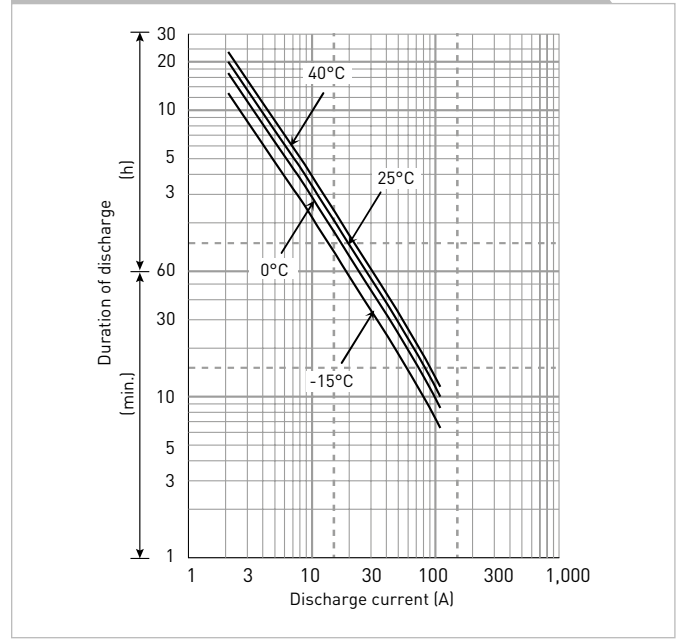

| WATT TABLE (25°C) | | | | | | | | | | | | | [Wattage/battery] | | | |
|-------------------|-------|--------|--------|--------|--------|--------|-----|------|-----|-----|-----|------|-------------------|------|------|--|
| Cut-off | 5min. | 10min. | 15min. | 20min. | 30min. | 45min. | 1h | 1.5h | 2h | 3h | 4h | 5h | 6h | 10h | 20h | |
| 9.6V | 1,483 | 1,254 | 966 | 835 | 625 | 410 | 312 | 241 | 187 | 132 | 110 | 89.9 | 79.1 | 48.0 | 25.2 | |
| 9.9V | 1,405 | 1,232 | 955 | 824 | 607 | 407 | 310 | 234 | 186 | 130 | 109 | 89.4 | 78.5 | 48.0 | 25.2 | |
| 10.2V | 1,327 | 1,210 | 943 | 812 | 596 | 406 | 307 | 217 | 184 | 127 | 108 | 88.9 | 77.9 | 48.0 | 25.2 | |
| 10.5V | 1,249 | 1,176 | 920 | 800 | 585 | 405 | 306 | 211 | 179 | 126 | 107 | 88.5 | 76.7 | 48.0 | 25.2 | |
| 10.8V | 1,215 | 1,086 | 886 | 777 | 573 | 390 | 295 | 201 | 173 | 121 | 105 | 87.5 | 75.5 | 48.0 | 25.2 | |

| AMPERE TABLE (25°C) | | | | | | | | | | | | | [Ampere/battery] | | | |
|---------------------|-------|--------|--------|--------|--------|--------|------|------|------|------|------|------|------------------|------|------|--|
| Cut-off | 5min. | 10min. | 15min. | 20min. | 30min. | 45min. | 1h | 1.5h | 2h | 3h | 4h | 5h | 6h | 10h | 20h | |
| 9.6V | 133 | 112 | 84.0 | 72.0 | 53.4 | 34.9 | 26.5 | 20.4 | 15.8 | 11.1 | 9.20 | 7.50 | 6.60 | 4.00 | 2.10 | |
| 9.9V | 126 | 110 | 83.0 | 71.0 | 51.9 | 34.7 | 26.3 | 19.8 | 15.7 | 10.9 | 9.10 | 7.46 | 6.50 | 4.00 | 2.10 | |
| 10.2V | 119 | 108 | 82.0 | 70.0 | 50.9 | 34.6 | 26.1 | 18.4 | 15.5 | 10.7 | 9.00 | 7.42 | 6.50 | 4.00 | 2.10 | |
| 10.5V | 112 | 105 | 80.0 | 69.0 | 50.0 | 34.5 | 26.0 | 17.9 | 15.1 | 10.6 | 8.90 | 7.38 | 6.40 | 4.00 | 2.10 | |
| 10.8V | 109 | 97.0 | 77.0 | 67.0 | 49.0 | 33.2 | 25.0 | 17.0 | 14.6 | 10.2 | 8.80 | 7.30 | 6.30 | 4.00 | 2.10 | |

All mentioned values are average values

LC-P1242P

CHARGING METHOD (25°C)

Trickle use Control voltage: 13.6V - 13.8V
Initial current: 6.30A or smaller

CUT-OFF VOLTAGE

| | | | | | |
|--------------------------|---------------|---------------|---------------|---------------|--------------|
| Discharge current | 2.10A - 8.40A | 8.40A - 21.0A | 21.0A - 42.0A | 42.0A - 84.0A | 84.0A - 126A |
| Cut-off voltage | 10.5V | 10.2V | 9.9V | 9.3V | 8.7V |

INFLUENCE OF TEMPERATURE ON TRICKLE LIFE

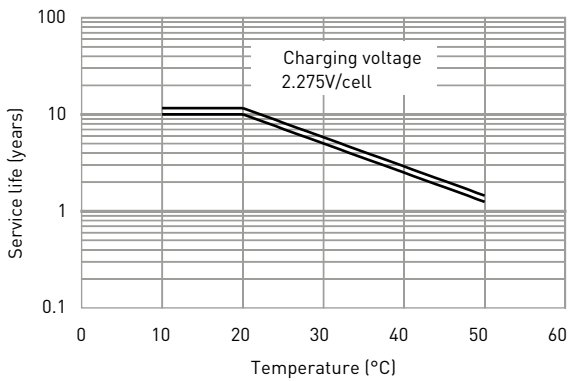

RESIDUAL CAPACITY TEST RESULT

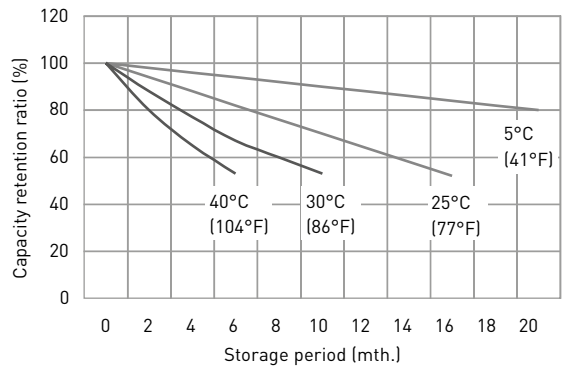

CONSTANT-VOLTAGE CONSTANT-CURRENT CHARGE CHARACTERISTICS FOR TRICKLE USE

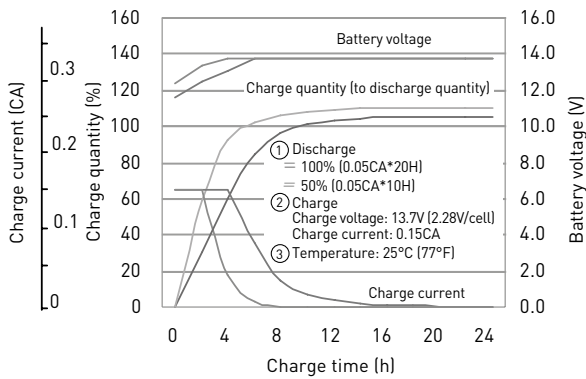

DISCHARGE CAPACITY BY TEMPERATURE AND BY DISCHARGE CURRENT

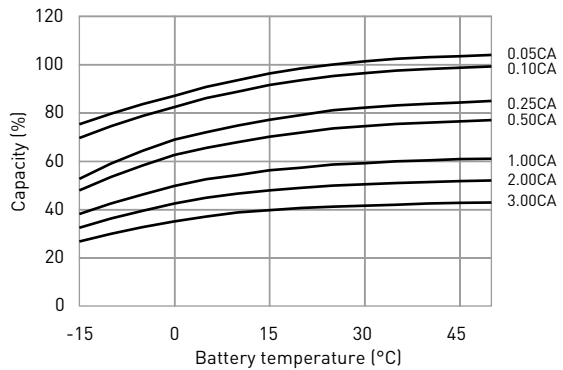

DISCHARGE CHARACTERISTICS

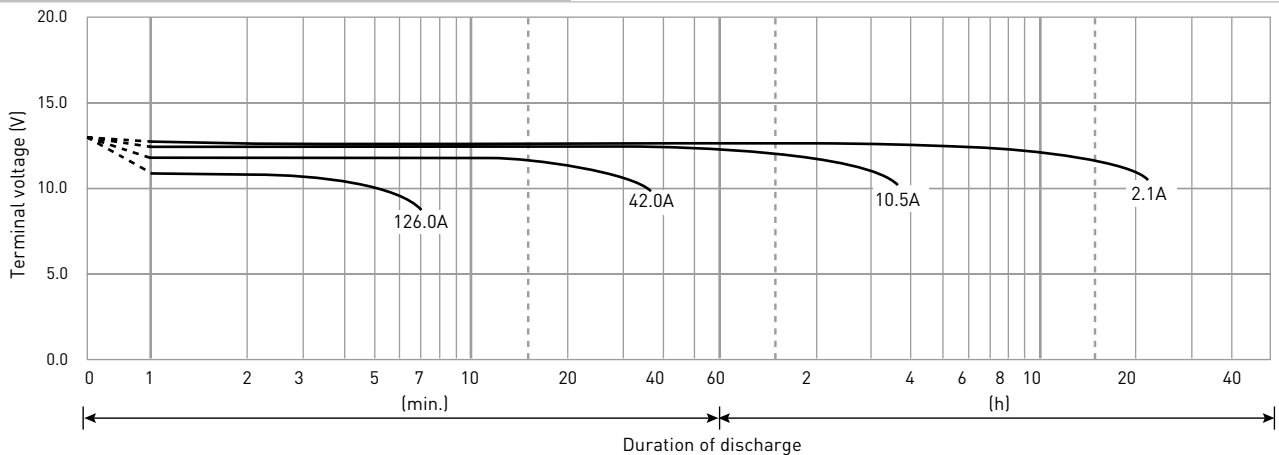

The data in this document are for descriptive purposes only and are not intended to make or imply any guarantee or warranty. Regarding handling and safety please consult our VRLA technical handbook chapter 1.