

SPECIFICATIONS:

CONTACT RATING: 6A 125VAC 3A 250VAC.
ELECTRICAL LIFE: 10,000 cycles.
MECHANICAL LIFE: 10,000 cycles.
CONTACT RESISTANCE: 20m-ohms.
INSULATION RESISTANCE: DC 500V 100M-ohms min.
DIELECTRIC STRENGTHS: AC 1000V 1 min.

MATERIALS:

HOUSING: 66 Nylon(UL 94V-2).
ACTUATOR: 66 Nylon(UL 94V-2).
MOVABLE CONTACTS: Copper, silver plated.
STATIONARY CONTACTS: Copper, silver plated.
TERMINALS: Copper, silver plated.
CONTACT SPRING: Piano wire.

Art. Nr.
RND 210-00544

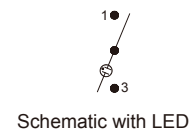
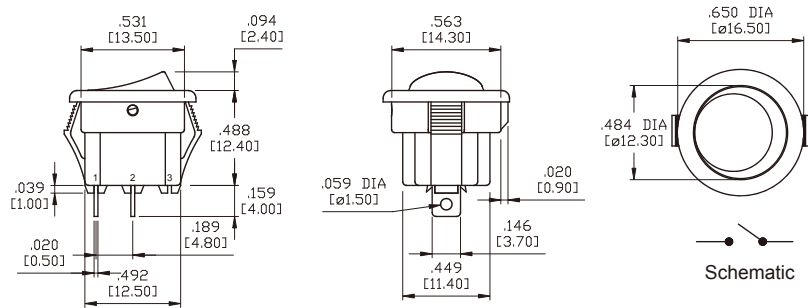

MARK

