

T-1 (3 mm) High Performance TS AlGaAs Red LED Lamps

Technical Data

HLMP-J100
HLMP-J105
HLMP-J150
HLMP-J155

Features

- High Light Output over a Wide Range of Currents (500 μ A to 50 mA)
- Popular T-1 Package
- Low Forward Voltage
- Low Power Dissipation
- Deep Red Color
- Long Life: Solid State Reliability
- Wide Viewing Angles
- Available on Tape and Reel

Applications

- Outdoor Message Boards
- Automotive Lighting
- Portable Equipment
- Safety Lighting Equipment
- Medical Equipment
- Changeable Message Signs

Package Dimensions

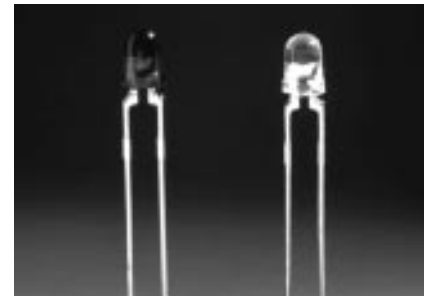
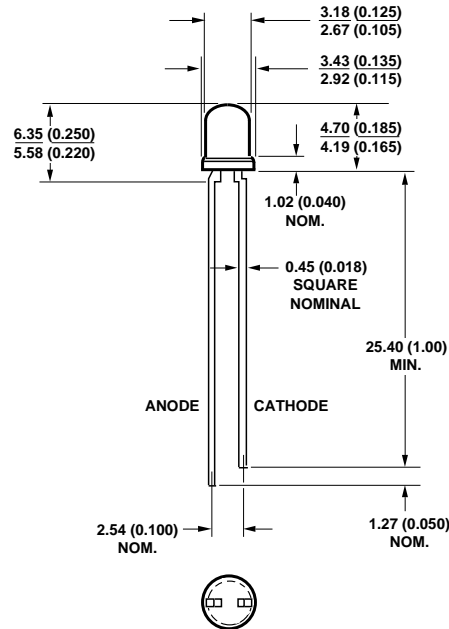

Description

The T-1 solid state lamps utilize a highly optimized LED material technology, transparent substrate aluminum gallium arsenide (TS AlGaAs). This LED technology has a very high luminous efficiency, capable of producing high light output over a wide range of drive currents (500 μ A to 50 mA). The color is deep red at a dominant wavelength of 644 nm. TS AlGaAs is a flip-chip LED technology, die attached to the anode lead and wire bonded to the cathode lead.

Device Selection Guide

| Package Description | Viewing Angle $2\theta^{1/2}$ | Deep Red $\lambda_d = 644 \text{ nm}$ | Typical I_V (mcd) $I_F = 20 \text{ mA}$ | Typical I_V (mcd) $I_F = 0.5 \text{ mA}$ |
|--|----------------------------------|--|---|--|
| T-1 (3 mm), Untinted, Non-diffused, Standard Current | 45° | HLMP-J105 | 340 | – |
| T-1 (3 mm), Untinted, Non-diffused, Low Current | 45° | HLMP-J155 | – | 6 |
| T-1 (3 mm), Tinted, Diffused, Standard Current | 55° | HLMP-J100 | 175 | – |
| T-1, (3 mm), Tinted, Diffused, Low Current | 55° | HLMP-J150 | – | 3 |

Absolute Maximum Ratings

| | |
|--|---------------------|
| Peak Forward Current ^[2] | 300 mA |
| Average Forward Current (@ $I_{PEAK} = 300$ mA) ^[1,2] | 30 mA |
| DC Forward Current ^[3] | 50 mA |
| Power Dissipation | 100 mW |
| Reverse Voltage ($I_R = 100$ μ A) | 5 V |
| Transient Forward Current (10 μ s Pulse) ^[4] | 500 mA |
| Operating Temperature Range | -55 to +100°C |
| Storage Temperature Range | -55 to +100°C |
| LED Junction Temperature | 110°C |
| Solder Temperature | 260°C for 5 seconds |
| [1.6 mm (0.063 in.) from body] | |

Notes:

1. Maximum I_{AVG} at $f = 1$ kHz, $DF = 10\%$.
2. Refer to Figure 6 to establish pulsed operating conditions.
3. Derate linearly as shown in Figure 5.
4. The transient peak current is the maximum non-recurring peak current the device can withstand without damaging the LED die and wire bonds. It is not recommended that the device be operated at peak currents above the Absolute Maximum Peak Forward Current.

Optical Characteristics at $T_A = 25^\circ\text{C}$

| Part Number | Luminous Intensity I_V (mcd) @ 20 mA ^[1] | | Total Flux ϕ_V (mIm) @ 20 mA ^[2] Typ. | Peak Wavelength λ_{PEAK} (nm) Typ. | Color, Dominant Wavelength λ_d ^[3] (nm) Typ. | Viewing Angle $2\theta^{1/2}$ (Degrees) ^[4] Typ. | Luminous Efficacy η_V (lm/w) |
|-------------|---|------|--|---|--|--|-----------------------------------|
| | Min. | Typ. | | | | | |
| HLMP-J105 | 56.4 | 340 | 280 | 654 | 644 | 45 | 85 |
| HLMP-J100 | 35.2 | 175 | | 654 | 644 | 55 | 85 |

Optical Characteristics at $T_A = 25^\circ\text{C}$

| Part Number (Low Current) | Luminous Intensity I_V (mcd) @ 0.5 mA ^[1] | | Total Flux ϕ_V (mIm) @ 0.5 mA ^[2] Typ. | Peak Wavelength λ_{PEAK} (nm) Typ. | Color, ZDominant Wavelength λ_d ^[3] (nm) Typ. | Viewing Angle $2\theta^{1/2}$ (Degrees) ^[4] Typ. | Luminous Efficacy η_V (lm/w) |
|---------------------------|--|------|---|---|---|--|-----------------------------------|
| | Min. | Typ. | | | | | |
| HLMP-J155 | 2.1 | 6.0 | 37.2 | 654 | 644 | 45 | 85 |
| HLMP-J150 | 1.3 | 3.0 | | 654 | 644 | 55 | 85 |

Notes:

1. The luminous intensity, I_V , is measured at the mechanical axis of the lamp package. The actual peak of the spatial radiation pattern may not be aligned with this axis.
2. ϕ_V is total luminous flux output as measured with an integrating sphere.
3. The dominant wavelength, λ_d , is derived from the CIE Chromaticity Diagram and represents the color of the device.
4. $\theta^{1/2}$ is the off-axis angle where the luminous intensity is 1/2 the peak intensity.

Electrical Characteristics at $T_A = 25^\circ\text{C}$

| Part Number | Forward Voltage V_F (Volts) @ $I_F = 20\text{ mA}$ | | Reverse Breakdown V_R (Volts) @ $I_R = 100\ \mu\text{A}$ | | Capacitance C (pF) $V_F = 0$, $f = 1\text{ MHz}$ Typ. | Thermal Resistance $R\theta_{J-PIN}$ ($^\circ\text{C}/\text{W}$) | Speed of Response τ_s (ns) Time Constant e^{-t/τ_s} Typ. |
|-------------|---|------|---|------|---|---|--|
| | Typ. | Max. | Min. | Typ. | | | |
| HLMP-J105 | 1.9 | 2.4 | 5 | 20 | 20 | 290 | 45 |
| HLMP-J100 | 1.9 | 2.4 | 5 | 20 | 20 | 290 | 45 |

Electrical Characteristics at $T_A = 25^\circ\text{C}$

| Part Number (Low Current) | Forward Voltage V_F (Volts) @ $I_F = 0.5\text{ mA}$ | | Reverse Breakdown V_R (Volts) @ $I_R = 100\ \mu\text{A}$ | | Capacitance C (pF) $V_F = 0$, $f = 1\text{ MHz}$ Typ. | Thermal Resistance $R\theta_{J-PIN}$ ($^\circ\text{C}/\text{W}$) | Speed of Response τ_s (ns) Time Constant e^{-t/τ_s} Typ. |
|------------------------------|--|------|---|------|---|---|--|
| | Typ. | Max. | Min. | Typ. | | | |
| HLMP-J155 | 1.6 | 1.9 | 5 | 20 | 20 | 290 | 45 |
| HLMP-J150 | 1.6 | 1.9 | 5 | 20 | 20 | 290 | 45 |

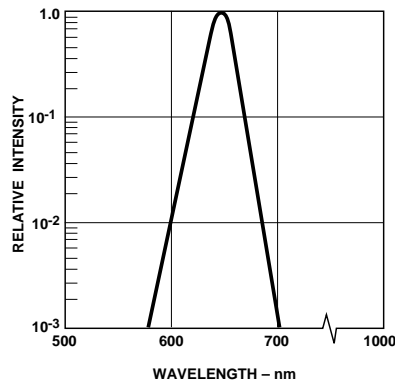

Figure 1. Relative Intensity vs. Wavelength.

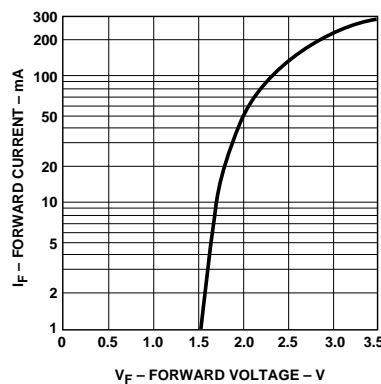

Figure 2. Forward Current vs. Forward Voltage.

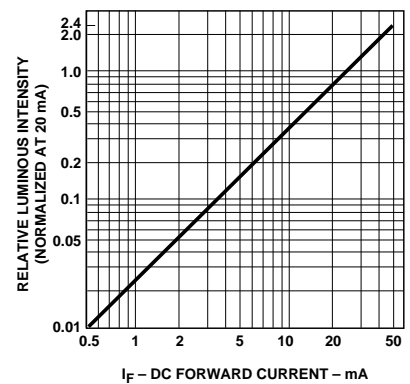

Figure 3. Relative Luminous Intensity vs. DC Forward Current.

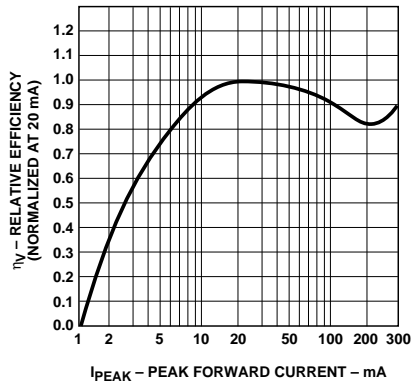
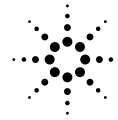

Figure 4. Relative Efficiency vs. Peak Forward Current.

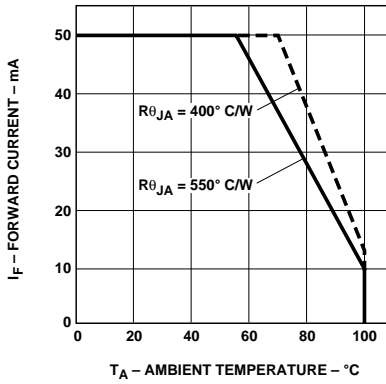

Figure 5. Maximum Forward DC Current vs. Ambient Temperature. Derating Based on $T_{JMAX} = 110\text{ }^{\circ}\text{C}$.

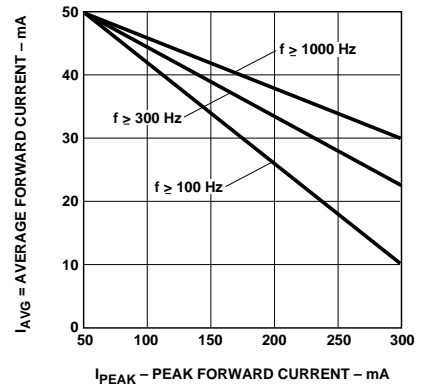

Figure 6. Maximum Average Current vs. Peak Forward Current.

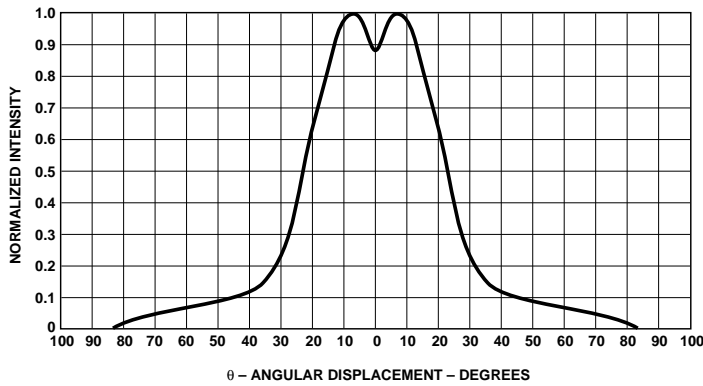

Figure 7. Normalized Luminous Intensity vs. Angular Displacement. HLMP-J105/J155.

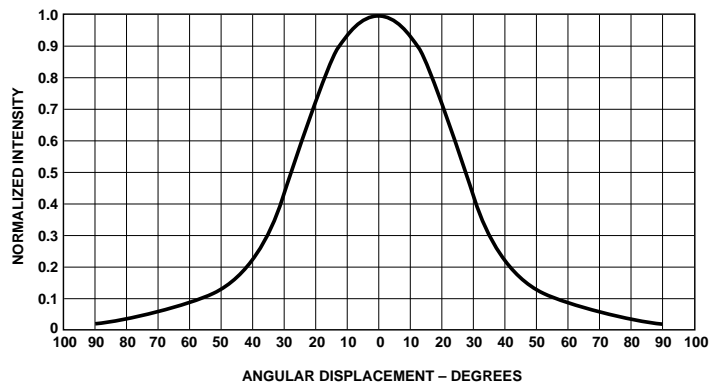

Figure 8. Normalized Luminous Intensity vs. Angular Displacement. HLMP-J100/J150.