

DESCRIPTION

The MP9361 is a high performance, regulated charge pump converter. Its input voltage ranges from 2.8V to V_{out} . The output voltage is regulated to a fixed 5V. No external inductor is required for simplicity and compactness. Internal soft-start circuit effectively reduces the in-rush current both while start-up and mode change.

The MP9361 is available in a compact TSOT23-6 package

FEATURES

- Input Voltage Range: 2.8V to 5V
- Internal Soft-Start
- Output Maximum Current up to 110mA
- Fixed 5V Output Voltage with 30mV Ripple
- 2X Charge Pump
- Fixed 1.35MHz Switching Frequency
- Over Current Protection
- Short Circuit Protection
- In-rush Current limit
- TSOT23-6 package and Lead (pb)-Free

APPLICATIONS

- Cell phone, Smart phone, LED backlight
- PDA or hand Held Computer
- Camera Flash White LED
- LCD Display Supply
- TV-Remote Control

"MPS" and "The Future of Analog IC Technology" are Registered Trademarks of Monolithic Power Systems, Inc.

TYPICAL APPLICATION

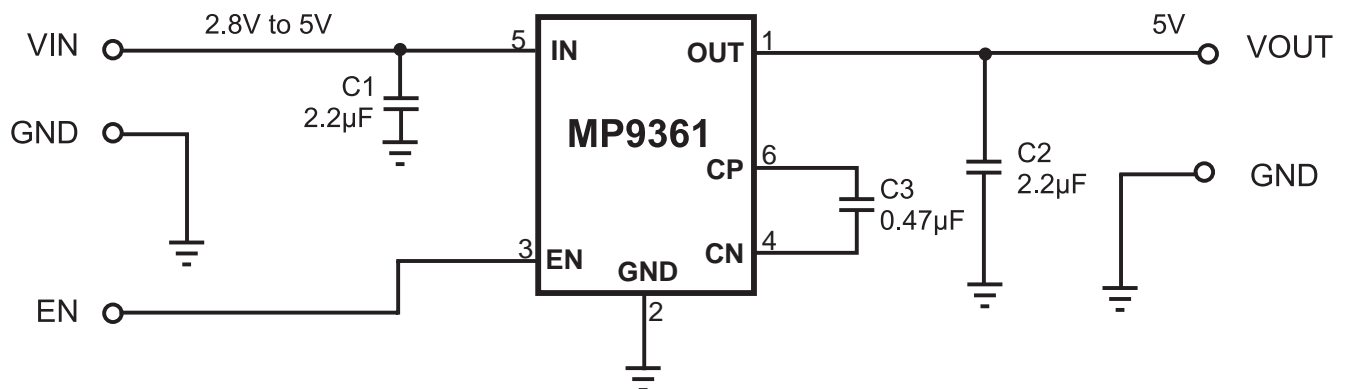

PACKAGE REFERENCE

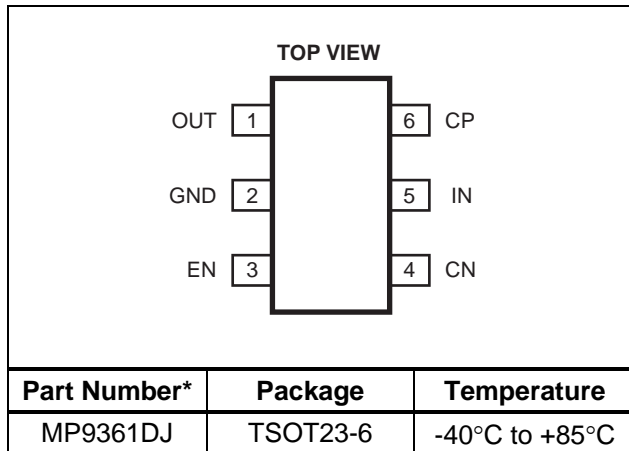

* For Tape & Reel, add suffix -Z (e.g. MP9361DJ-Z)
 For RoHS compliant packaging, add suffix -LF
 (e.g. MP9361DJ-LF-Z)

ABSOLUTE MAXIMUM RATINGS ⁽¹⁾

Supply Input Voltage -0.3V to +6.0V
 All Other Pins..... -0.3V to +6.0V
 Storage Temperature -65°C to +150°C

Recommended Operating Conditions ⁽²⁾

Supply Voltage V_{IN} 2.8V to 5.0V
 Output Voltage V_{OUT} 5.0V
 Operating Temperature -40°C to +85°C

Thermal Resistance ⁽³⁾ θ_{JA} θ_{JC}
 TSOT23-6..... 195..... 25... °C/W

Notes:

- 1) Exceeding these ratings may damage the device.
- 2) The device is not guaranteed to function outside of its operating conditions.
- 3) Measured on approximately 1" square of 1 oz copper.

ELECTRICAL CHARACTERISTICS

$V_{IN}=3.7V$, $C_{IN}=C_{OUT}=2.2\mu F$, $C_P=0.22\mu F$, $T_A=25^\circ C$, Unless otherwise noted

Parameter	Symbol	Condition	Min	Typ	Max	Units
Input Supply Voltage	V_{IN}		2.8		5	V
Output Voltage	V_{OUT}	$V_{IN}>3.2V$, $I_{OUT}<110mA$	4.8	5	5.2	V
Quiescent Current	I_Q	$I_{OUT}=0$		2	4	mA
Maximum Output Current	I_O	$V_{IN}>3.2V$	110			mA
Over Current Protection	I_{OCP}	$V_{OUT}=5V$	250	350	500	mA
Short Circuit Protection	I_{SHORT}			60	90	mA
Output Ripple		$I_{OUT}=60mA$		30		mV
Shut Down Current	I_{SHDN}	$V_{IN}=4.5V$, $V_{EN}<0.4V$		0.1	1	μA
Operation Frequency	F_{OSC}		1.1	1.35	1.6	MHz
Enable Voltage, High	V_{EN} (HIGH)			1.5		V
Enable Voltage, Low	V_{EN} (LOW)			0.4		V
Enable Pin Leakage	I_{EN}	$V_{EN}=5V$		0.2	1	μA

PIN FUNCTIONS

Pin #	Name	Description
1	OUT	Output Voltage. Decoupled with a 2.2 μF ceramic capacitor for a load current less than 60mA. For a load current greater than 60mA, use 10 μF decoupling capacitor.
2	GND	Ground.
3	EN	Device Enable: A logic high input ($V_{EN}>1.5V$) turns on the regulator. A logic low input ($V_{EN}>0.4V$)
4	CN	Flying Capacitor Negative Terminal.
5	IN	Input.
6	CP	Flying Capacitor Positive Terminal.

TYPICAL PERFORMANCE CHARACTERISTICS

$V_{IN}=3.7V$, $V_{OUT}=5V$, $C1=C2=2.2\mu F$, $C3=0.47\mu F$. $T_A=25^\circ C$, unless otherwise noted.

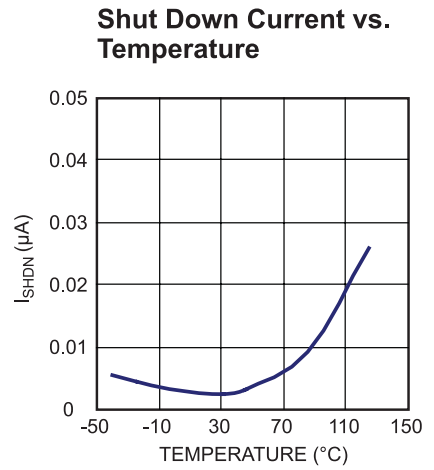
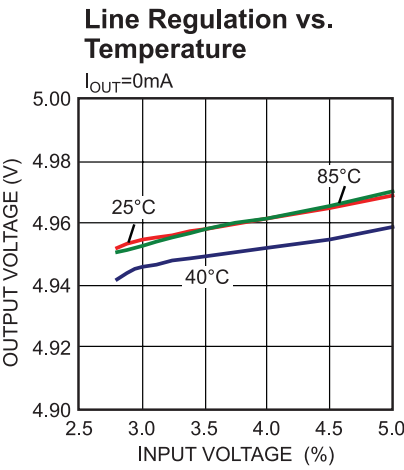
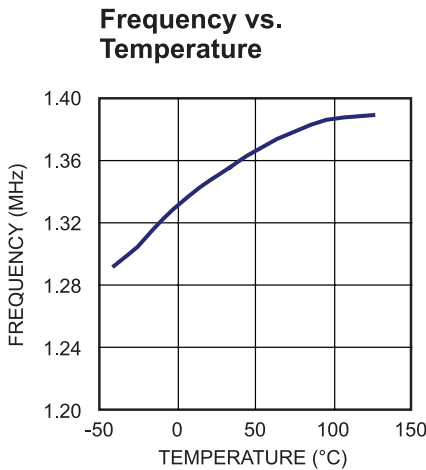
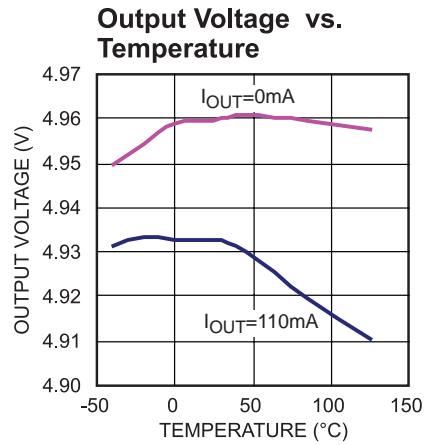
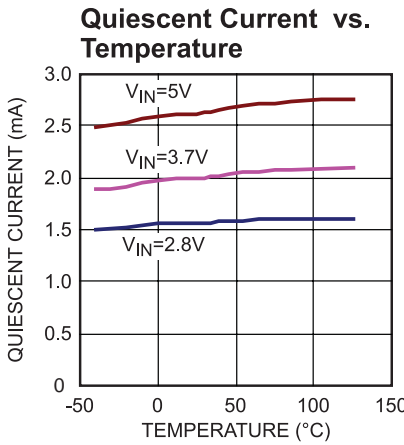
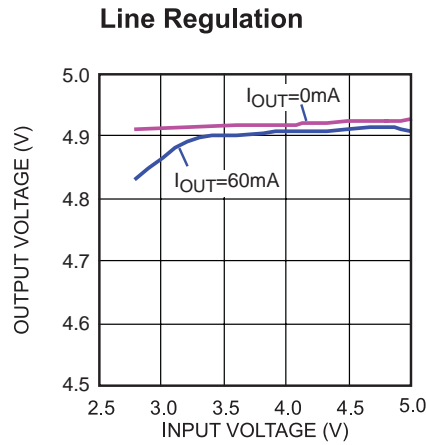
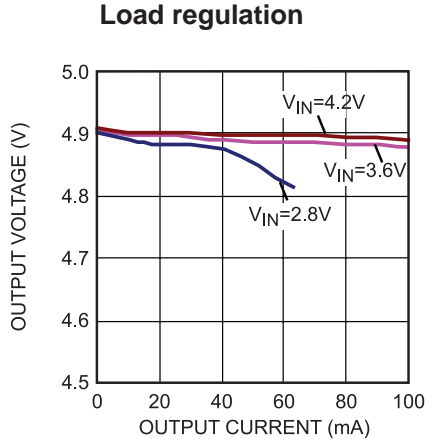
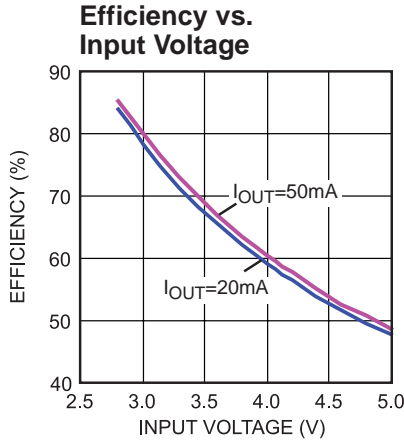
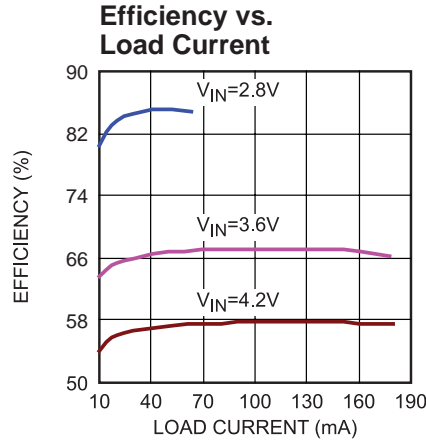

TYPICAL PERFORMANCE CHARACTERISTICS

$V_{IN}=3.7V$, $V_{OUT}=5V$, $C1=C2=2.2\mu F$, $C3=0.47\mu F$. $T_A=25^\circ C$ Unless otherwise noted. (continued)

Inrush Current

$V_{IN}=2.8V$, $I_{OUT}=64mA$
with resistor load

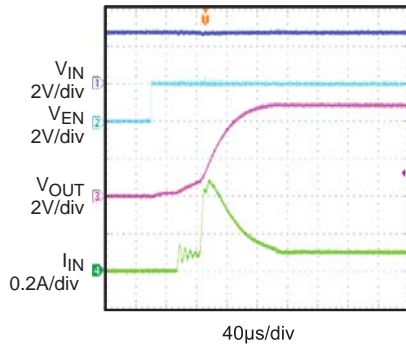

Inrush Current

$V_{GN}=V_{IN}=3.6V$, $I_{OUT}=64mA$
with resistor load

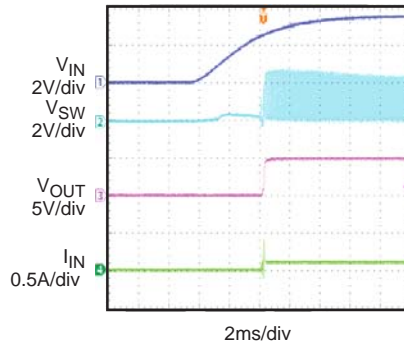

Load PWM Dimming Operation

$V_{EN}=V_{IN}=2.8V$, $F_{PWM}=100HZ$

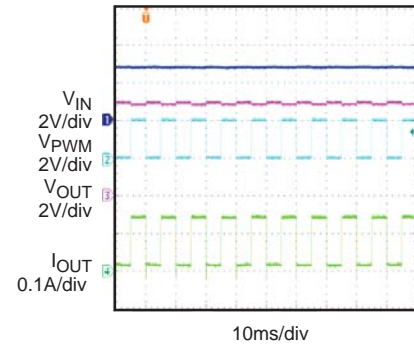

Load PWM Dimming Operation

$V_{EN}=V_{IN}=2.8V$, $F_{PWM}=2KHZ$

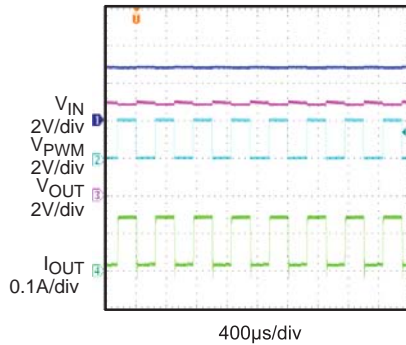

Normal Load Ripple

$V_{EN}=V_{IN}=2.8V$, $V_{OUT}=5V$, $I_{OUT}=60mA$

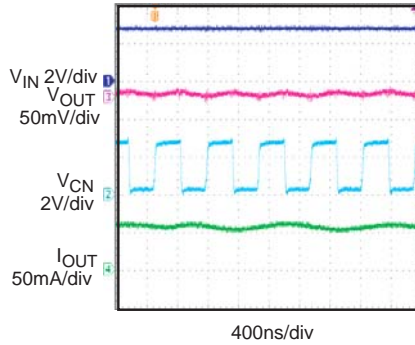

Normal Load Ripple

$V_{IN}=V_{EN}=4V$, $I_{OUT}=60mA$

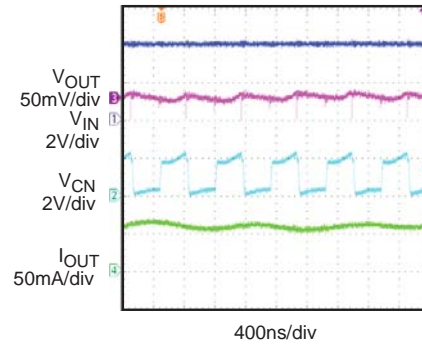

OPERATION

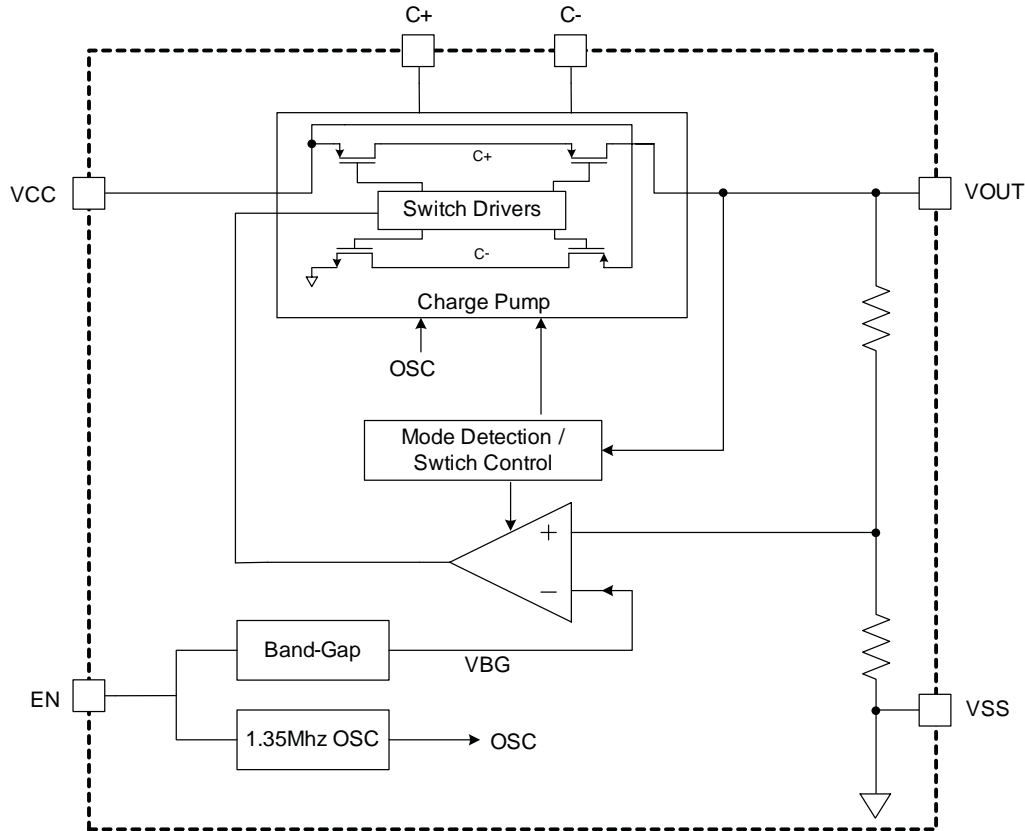

Figure 1— Functional Block Diagram

The MP9361 uses a switched capacitor charge pump to boost an input voltage to a regulated output voltage. Regulation is achieved by sensing the charge pump output voltage through an internal resistor divider network. A switched doubling circuit is enabled when the divided output drops below a preset trip point controlled by an internal comparator.

The switching signal, which drives the charge pump, is created by an integrated oscillator within the control circuit block. The fixed charge pump switching frequency is approximately 1.35MHz.

The MP9361 has complete output short-circuit and thermal protection to safeguard the device under extreme operating conditions. An internal thermal protection circuit senses die temperature and will shut down the device if the internal junction temperature exceeds approximately 145°C. The charge pump will remain disabled until the fault condition is relieved.

PACKAGE INFORMATION

TSOT23-6

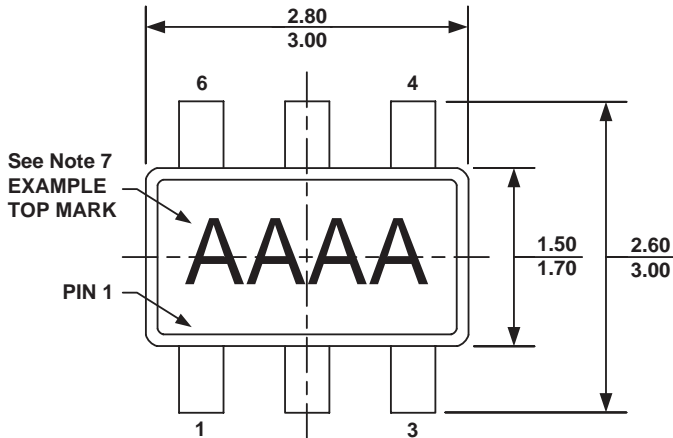

TOP VIEW

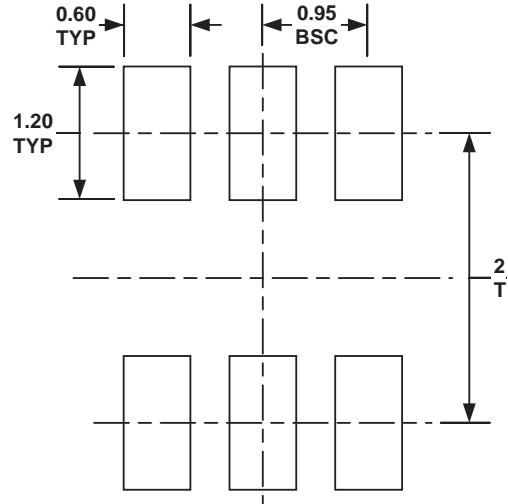

RECOMMENDED LAND PATTERN

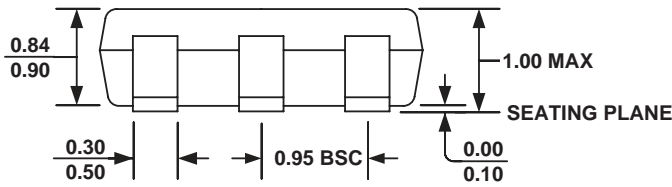

FRONT VIEW

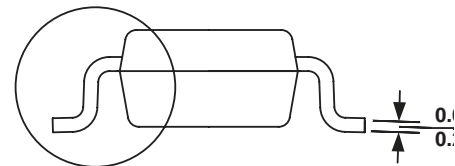

SEE DETAIL "A"

SIDE VIEW

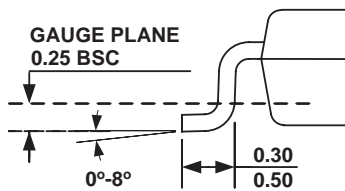

DETAIL A

NOTE:

- 1) ALL DIMENSIONS ARE IN MILLIMETERS.
- 2) PACKAGE LENGTH DOES NOT INCLUDE MOLD FLASH, PROTRUSION OR GATE BURR.
- 3) PACKAGE WIDTH DOES NOT INCLUDE INTERLEAD FL OR PROTRUSION.
- 4) LEAD COPLANARITY (BOTTOM OF LEADS AFTER FORMING) SHALL BE 0.10 MILLIMETERS MAX.
- 5) DRAWING CONFORMS TO JEDEC MO-193, VARIATION 3.
- 6) DRAWING IS NOT TO SCALE.
- 7) PIN 1 IS LOWER LEFT PIN WHEN READING TOP MARK LEFT TO RIGHT, (SEE EXAMPLE TOP MARK)

NOTICE: The information in this document is subject to change without notice. Users should warrant and guarantee that third party Intellectual Property rights are not infringed upon when integrating MPS products into any application. MPS will not assume any legal responsibility for any said applications.