

Reflexlichtschranke
Reflective Optical Switch
Lead (Pb) Free Product - RoHS Compliant

SFH 7740



Wesentliche Merkmale

- Arbeitsabstand: 0.5 - 4 mm
- Arbeitsbereich einstellbar
- Optohybrid mit Schmitt-Trigger Ausgang, open drain
- Extrem niedriger Stromverbrauch
- Sehr kleines SMD Gehäuse
- Hohe Umgebungslicht Unterdrückung

Anwendungen

- Positionserkennung von Abdeckungen für Batteriefächer, Foto-Objektiven usw.
- Mobile Geräte

Features

- Working distance: 0.5 - 4 mm
- Working range adjustable
- Opto hybrid with Schmitt trigger output, open drain
- Extremely low power consumption
- Very small SMD package
- High ambient light suppression

Applications

- Position detection of sliding covers for battery-cases, camera lenses ect.
- Mobile devices

Typ Type	Bestellnummer Ordering Code
SFH 7740	Q65110A6668

An application note is available for this product.
Please contact your appropriate OSRAM sales partner

Grenzwerte
Maximum Ratings

Bezeichnung Parameter	Symbol Symbol	Wert Value	Einheit Unit
Lagertemperatur Storage temperature	T_{stg}	min: - 40 max: + 85	°C
Versorgungsspannung Supply voltage	V_{dd}	0 - 6	V
Externe Spannung an Pin External voltage at pin Out Prog Test Anode LED	V_{out}	0 - 4.5 0 - 4.5 0 - 4.5 0 - 1.5	V
Sink current durch Ausgangstransistor Sink current through output transistor (please see figure 1)	I_{sink}	10	mA
Vorwärtsstrom ¹⁾ Forward current (please see figure 1)	I_f	60	mA
Elektrostatistische Entladung Electrostatic discharge - Human Body Model (according to: JESD22-A114E; Class2) - Machine Model (according to: JESD22-A115A; Class B)	<i>ESD</i>	2 200	kV V
latch up protection latch up protection (according to: EIA/JESD78 Class 1)		20	mA

¹⁾ Der Vorwärtsstrom I_f durch die LED ist abhängig von V_{dd} und R_{prog} wie folgt:

$$I_f = 10\text{mA} + \left(\frac{V_{dd} \times 6}{R_{prog}} \right)$$

* The forward current I_f depends on V_{dd} and R_{prog} as in the following formula:

Empfohlene Betriebsbedingungen Recommended Operating Conditions

Bezeichnung Parameter	Symbol Symbol	Wert Value			Einheit Unit
		min.	typ.	max.	
Betriebstemperatur Operating temperature	T_{op}	- 20		+ 85	°C
Versorgungsspannung Supply voltage	V_{dd}	2.4		3.6	V
Ausgangsspannung Output voltage (please see figure 1)	DV_{dd}	1.7		3.6	V
Rauschen der Versorgungsspannung ¹⁾ Supply voltage ripple frequency range 0...20kHz	dV_{dd}			200	mV
Pull-up Widerstand Pull-up resistor (please see figure 1)	$R_{pull-up}$	10		1000	kΩ
Abblock Kondensatoren Bypass capacitors (please see figure 1)	C_{bypass} - stabilisation - HF		>1 10 - 100		μF nF
Umgebungslicht Ambient light Normlicht / Standard light A	E_V $V_{dd} < 3V$ $V_{dd} > 3V$			2000 4000	lux

¹⁾ Der Emitter wird mit 10mA bis 60mA gepulst betrieben; das bedeutet, dass jeder Widerstand in Serie zu V_{dd} einen Spannungsabfall in der Versorgungsleitung verursacht. Es wird empfohlen, diesen Serienwiderstand so klein zu halten, dass max dV_{dd} nicht überschritten wird. Beim Betrieb des SFH 7740 im Labor ist vom Einsatz geregelter Spannungsversorgungen abzusehen. Durch das Einschalten der IRED wird die Quelle kurzzeitig belastet. Diese Belastung kann zu Spannungsschwankungen der Quelle führen, die wiederum die Funktion des SFH 7740 beeinträchtigen können. Im Normalbetrieb (Akku, Batterie, stabilisierte Netzteile) tritt dieser Effekt nicht auf.

* The emitter is driven with 10 mA to 60 mA in pulsed mode; this means, that any series resistance on the V_{dd} line causes a voltage drop at the power pin. It is recommended to keep the series resistance low, so that max dV_{dd} is not exceeded. When testing the SFH 7740 sensor in the lab, please do not use regulated voltage supplies. The IR emitter pulse is a high, short load for the power supply. This load can influence the stability of the output voltage; this instability will influence the operation of the SFH 7740. This effect does not occur during normal operation of the sensor with batteries, storage batteries, or stabilized voltage supplies.

Kennwerte (Ta = 25°C)

Characteristics

Bezeichnung Parameter	Symbol Symbol	Wert Value			Einheit Unit
		min.	typ.	max.	
Minimale Betriebsspannung für Startphase Minimum required supply voltage for start-up (please see figure 2)	$V_{dd, start}$	0.8		2.0	V
Länge der Startphase Start up time (please see figure 2)	t_{start}	60	90	120	ms
Mess-Wiederholzeit Measurement refresh time (please see figure 2)	$t_{refresh}$	60	90	120	ms
LED „An“ Zeit LED „ON“ Time (please see figure 3)	t_{pulse}	30	45	60	µs
Mittlere Stromaufnahme ¹⁾ Mean current consumption ¹⁾ $R_{Prog} = h, V_{dd} = 3V$	$I_{dd, mean}$		25	50	µA
Maximale Stromaufnahme Maximum current consumption $R_{Prog} = h, V_{dd} = 3V$	$I_{dd, max}$		10	20	mA
Mittlere Stromaufnahme ¹⁾ Mean current consumption ¹⁾ $R_{Prog} = 470 \Omega, V_{dd} = 3V$	$I_{dd, mean}$		45	75	µA
Maximale Stromaufnahme Maximum current consumption $R_{Prog} = 470 \Omega, V_{dd} = 3V$	$I_{dd, max}$		50	65	mA
Ausgangsleckstrom „high“ Output leakage current „high“ $DV_{dd} = 2.2V$	$I_{out, H}$		5	400	nA
Ausgangsspannung „low“ Output voltage „low“ $DV_{dd} = 2.2V; R_{pullup} = 270 \Omega$	$V_{out, L}$		0.1	0.5	V
Wellenlänge der max. Fotoempfindlichkeit Wavelength of max. sensitivity	$\lambda_{S, max}$		880		nm

Kennwerte (Ta = 25°C)

Characteristics

Bezeichnung Parameter	Symbol Symbol	Wert Value			Einheit Unit
		min.	typ.	max.	
Spektraler Bereich der Fotoempfindlichkeit $S = 10\%$ von S_{\max} Spectral range of sensitivity $S = 10\%$ of S_{\max}	λ	730		1080	nm
Wellenlänge der Strahlung des Emitters Wavelength at peak emission $I_F = 10$ mA	λ_{peak}		850		nm
Spektrale Bandbreite des Emitters bei 50% von I_{\max} Spectral bandwidth of the emitter at 50% of I_{\max} $I_F = 10$ mA	$\Delta\lambda$		30		nm

¹⁾ gepulster Betrieb: Dauer LED an: ~44µs / Dauer LED aus: ~90ms

* pulsed operating mode: LED on time: ~44µs / LED off time: ~90ms

Schaltabstand und Reflektoreigenschaften

Switching distance and reflector characteristics

Bezeichnung Parameter	Symbol Symbol	Wert Value			Einheit Unit
		min.	typ.	max.	
Reflektor Reflektivität Reflector reflectivity $\lambda = 850\text{nm}$	$R_{R\ 850\text{nm}}$	50			%
Absorber Reflektivität Absorber reflectivity $\lambda = 850\text{nm}$	$R_{A\ 850\text{nm}}$			9	%
Kontrast Verhältnis (Reflektor / Absorber) contrast ratio (Reflector / absorber)	$R_{R\ 850\text{nm}} / R_{A\ 850\text{nm}}$	10			
Reflektor und Absorber Größe ¹⁾ (B x L) Reflector and absorber size ¹⁾ (w x l)	$A_{\text{reflector}}$ A_{absorber}				
Einstellbarer Arbeitsabstand ²⁾ Adjustable working distance ²⁾	d	0.5		4	mm
Variation des Arbeitsabstandes ¹⁾ Variation of working distance ¹⁾	Δd			+/- 0.4	mm

¹⁾ siehe / see Application note: „Reflective Optical Sensor SFH 7740“.

²⁾ Der Arbeitsabstand d ist definiert von der Sensoroberfläche bis zum Reflektor. d_{min} und d_{max} können nur mit einem Reflektor (Reflektionsgrad $R > 60\%$) und Absorber ($R < 6\%$) erreicht werden.

* The working distance d is defined from top of the sensor to reflector surface. d_{min} and d_{max} can only be reached with a reflector (reflection coefficient $R > 60\%$) and absorber ($R < 6\%$).

Graph 1: Adjustment of different working distances by emitter current I_f and R_{prog} as func

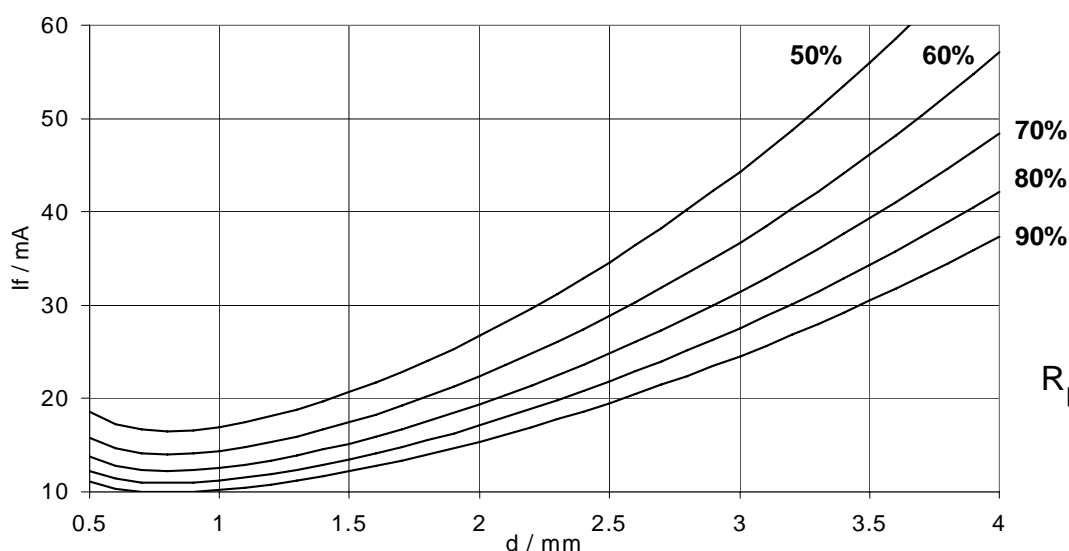

$$R_{\text{prog}} = \frac{V_{\text{dd}} \times 6}{I_f - 10\text{mA}}$$

Blockdiagramm (empfohlener Pull-Up-Widerstand $R_{pull\ up} = 10k\Omega \dots 100k\Omega$)

Block diagram (recommended Pull up resistance $R_{pull\ up} = 10k\Omega \dots 100k\Omega$)

Figure 1 **Blockdiagramm**
 Block diagram

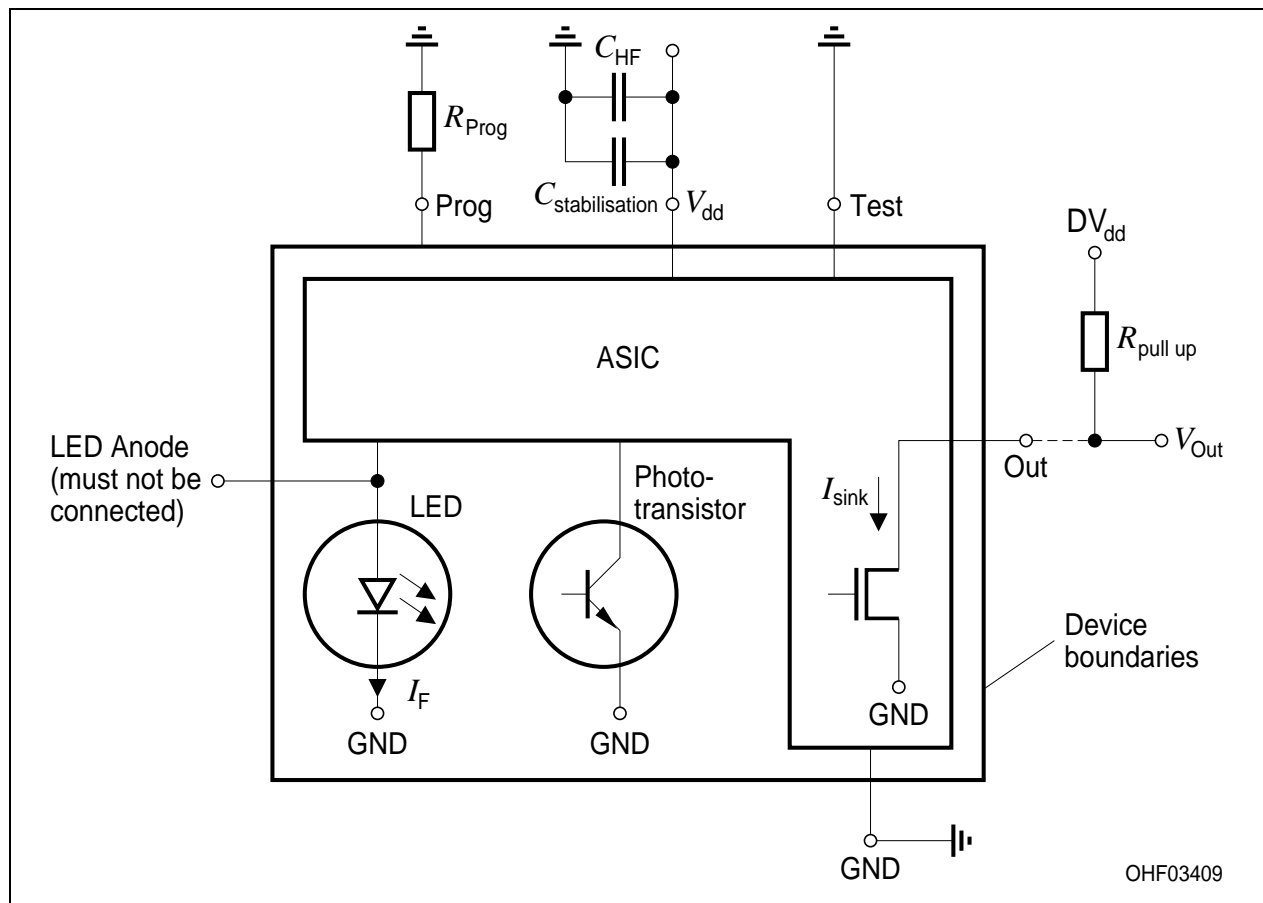

**Figure 2 Startverhalten
Start-up sequence**

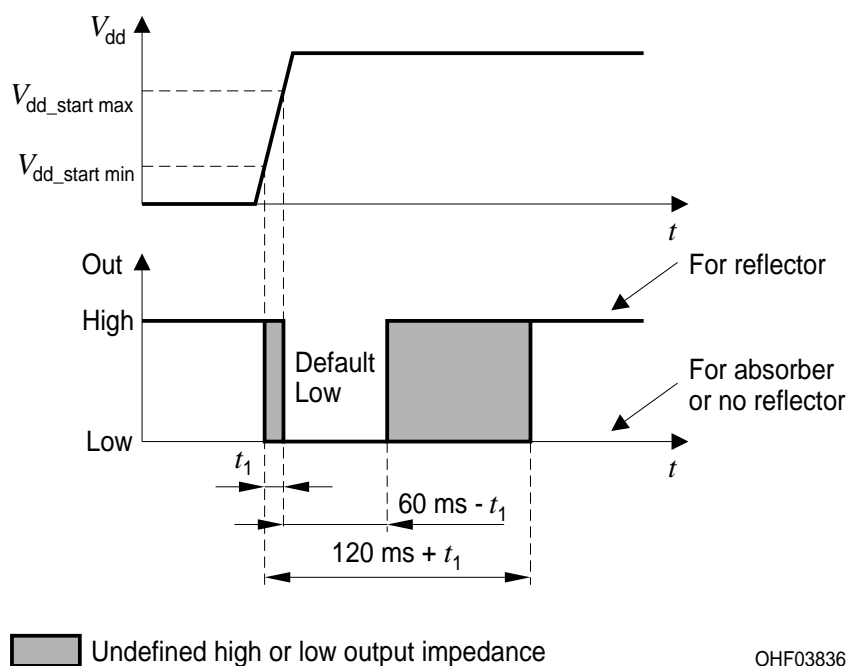

Der Ausgang ist immer hochohmig, wenn an V_{dd} keine Spannung angeschlossen ist. Wenn die Versorgungsspannung V_{dd_start} erreicht, bleibt der Ausgang für $60\text{ms} < t_{start} < 120\text{ms}$ auf „low“. Anschließend findet etwa alle 90ms eine Messung des reflektierten Signals statt und der Ausgang wird entsprechend geschaltet (Figure 3).

If the supply voltage at V_{dd} is not connected, the output is always high ohmic. When supply voltage reaches V_{dd_start} , the sensor output stays low for $60\text{ms} < t_{start} < 120\text{ms}$. Subsequently approx. every 90ms the reflected signal is measured and the output is set accordingly (Figure 3).

Figure 3 Timing diagram

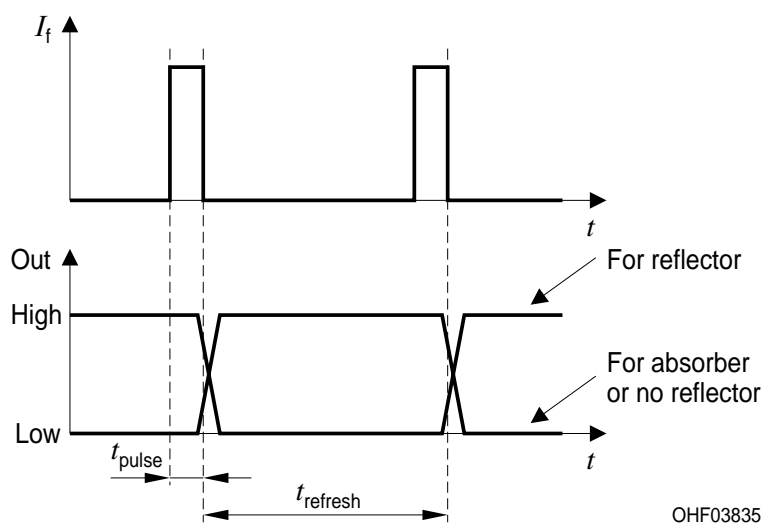

LED:
Relative Spectral Emission

$I_{rel} = f(\lambda); T_A = 25^\circ\text{C}$

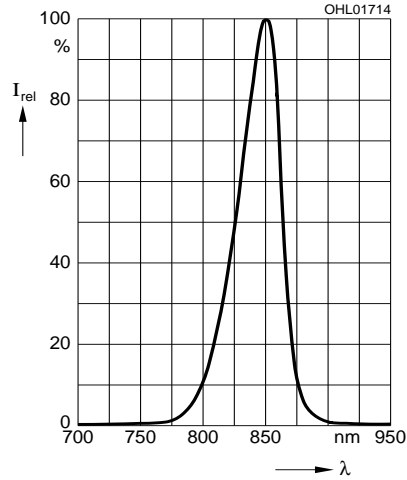

Phototransistor
Relative Spectral Sensitivity

$S_{rel} = f(\lambda); T_A = 25^\circ\text{C}$

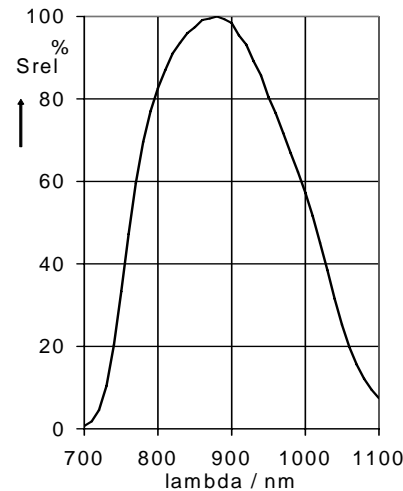

SFH 7740:
Mean current consumption

$I_{dd} = f(V_{dd}); R_{prog}; T_A = 25^\circ\text{C}$

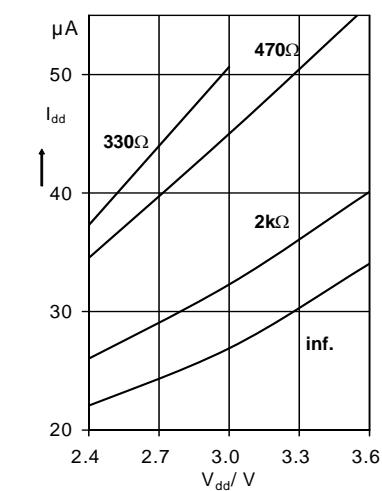

Maßzeichnung
Package Outlines

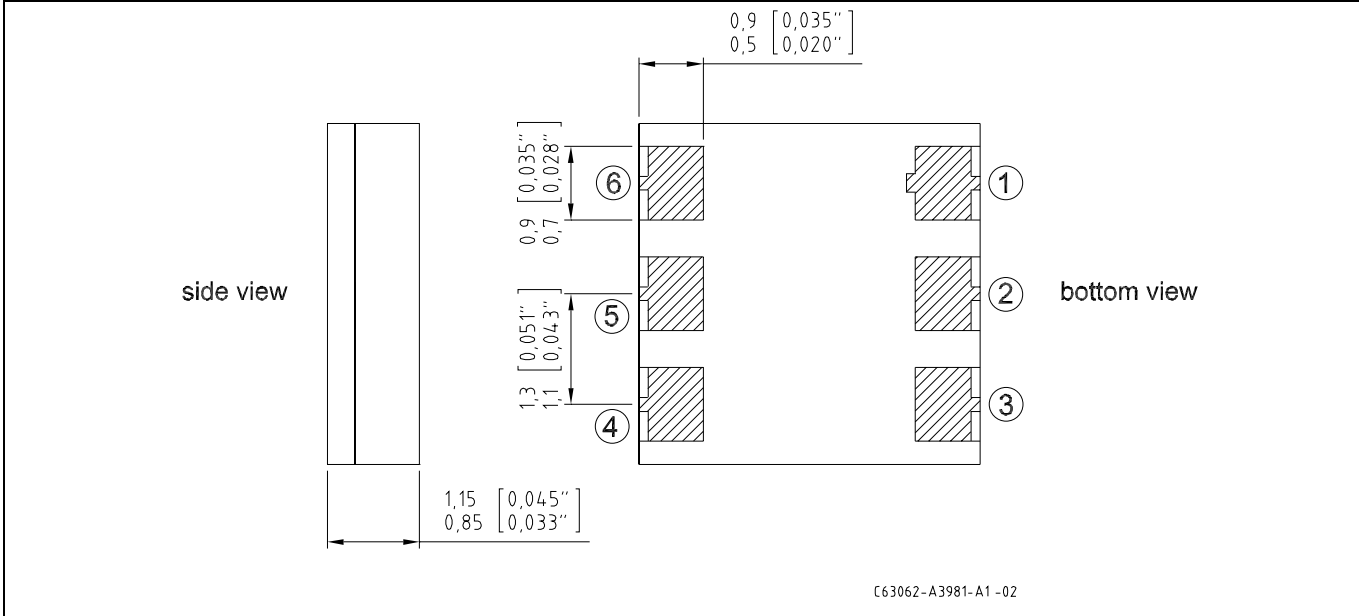
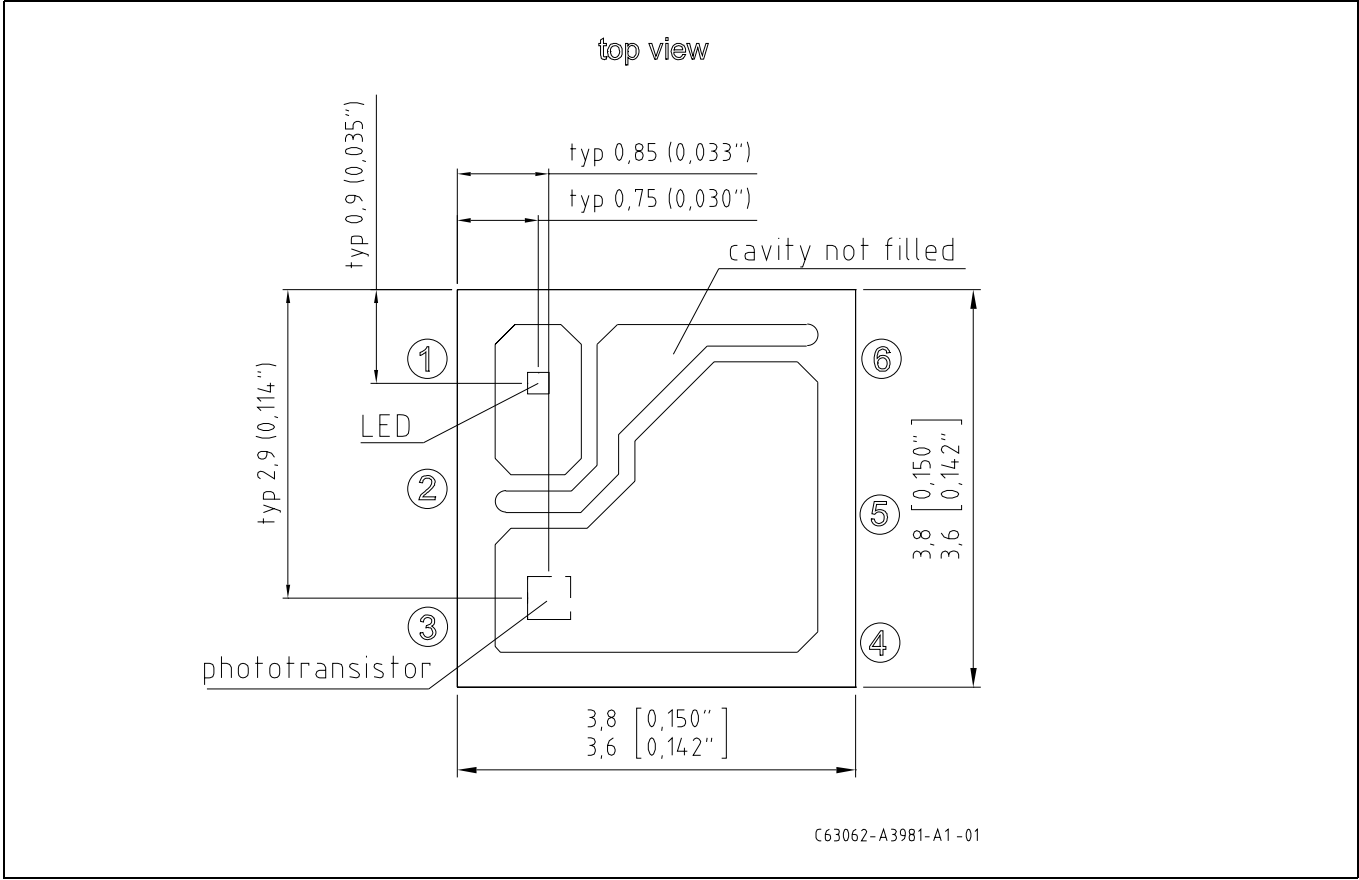

Maße in mm (inch) / Dimensions in mm (inch)

Anschlußbelegung Pin configuration

Pin #	Description
1	Anode LED (must not be connected)
2	GND
3	Out
4	Test (must be connected to GND)
5	V_{dd}
6	Prog

Bauteilaufnahme device pickup

Vakuum Pipette sollte das Bauteil am rechteckigen Außenrahmen fassen.

Laminar vacuum pickup nozzle should use the rectangular outer wall of the device for handling.

Empfohlenes Pickup Nadel Recommended pickup nozzle

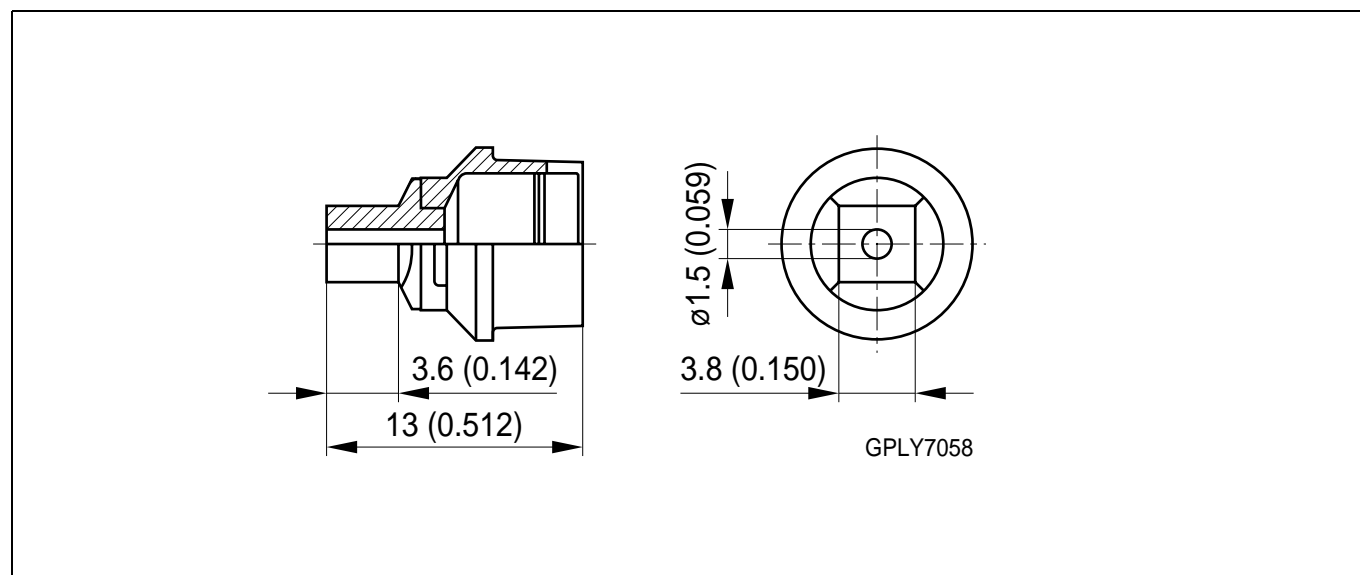

Maße in mm/ Dimensions in mm

Empfohlenes Lötpaddesign
Recommended Solderpad Design

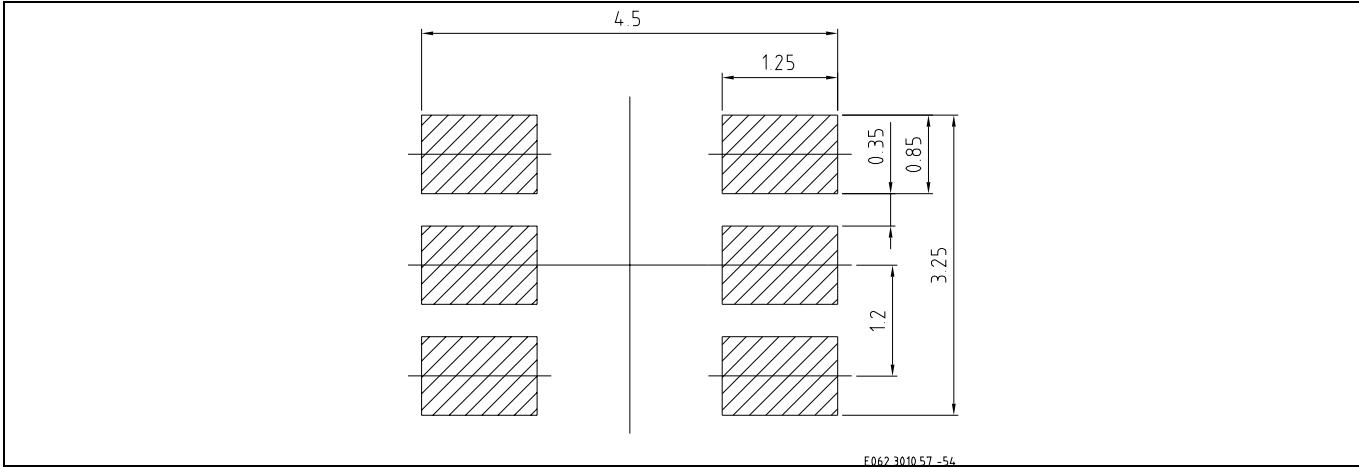

Maße in mm / Dimensions in mm

Gurtverpackung
Taping

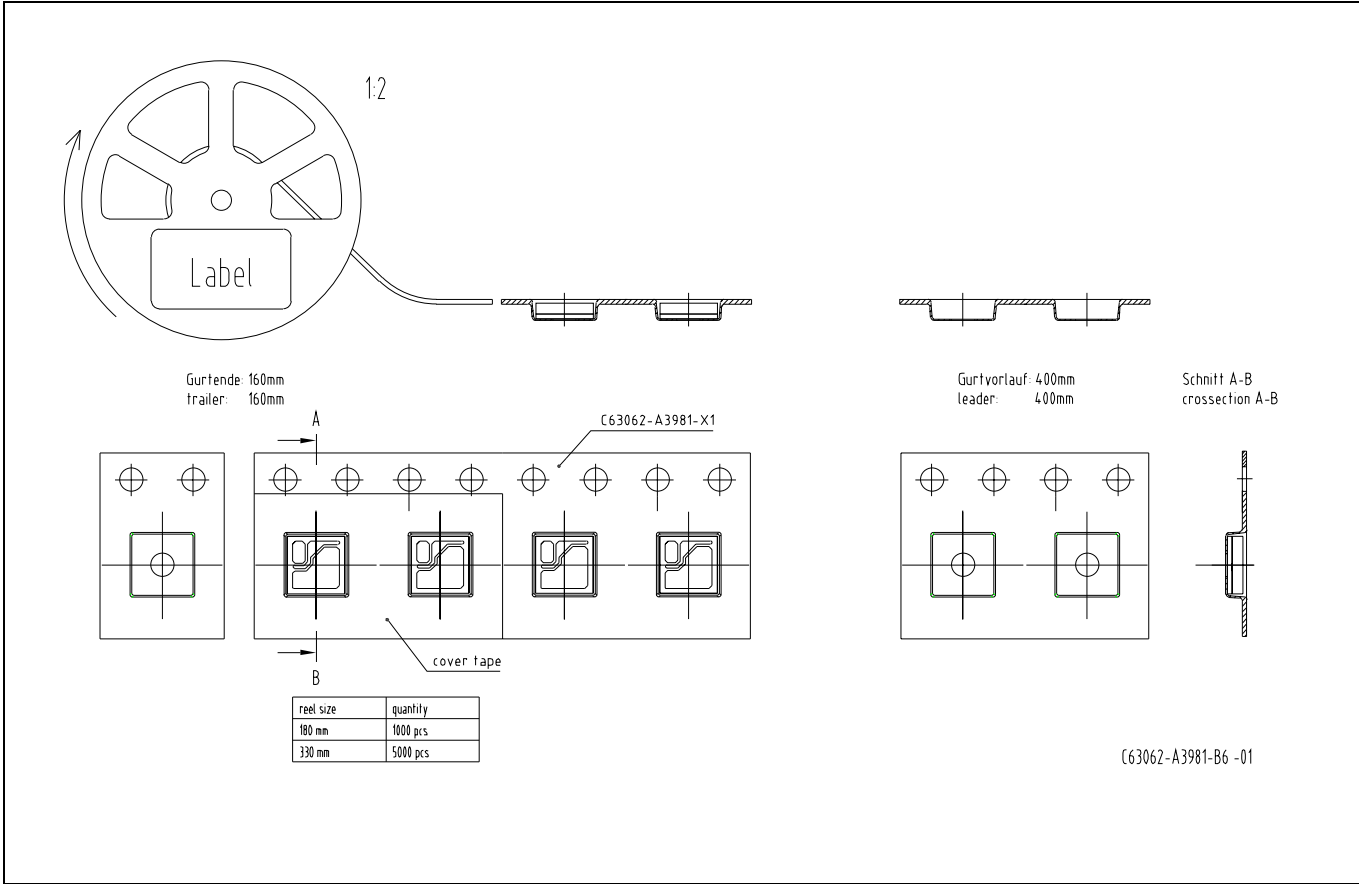

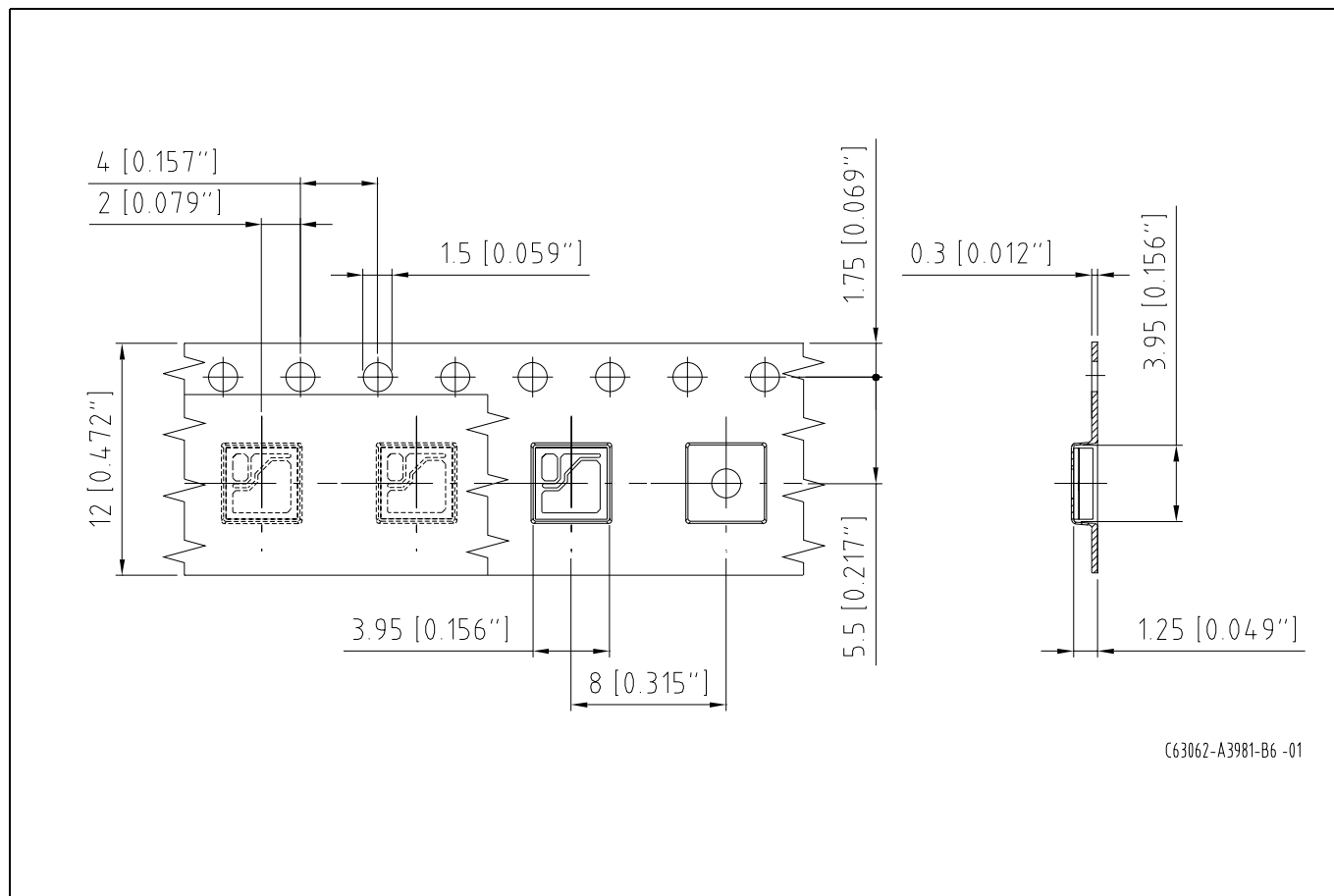

Maße in mm / Dimensions in mm

Lötbedingungen Soldering Conditions

Reflow Lötprofil für bleifreies Löten
Reflow Soldering Profile for lead free soldering

Vorbehandlung nach JEDEC Level 4
Preconditioning acc. to JEDEC Level 4
(nach J-STD-020C)
(acc. to J-STD-020C)

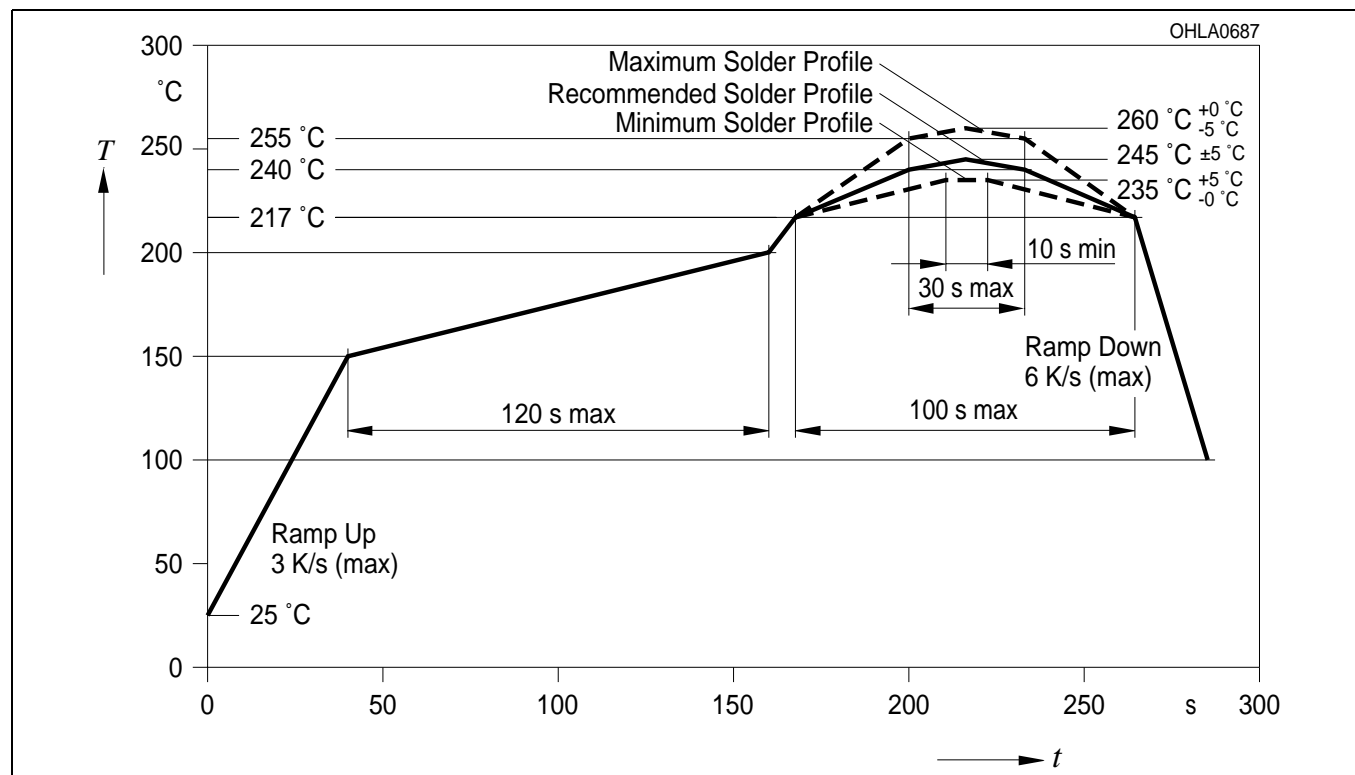

Published by
OSRAM Opto Semiconductors GmbH
Wernerwerkstrasse 2, D-93049 Regensburg
www.osram-os.com
© All Rights Reserved.

The information describes the type of component and shall not be considered as assured characteristics. Due to the special conditions of the manufacturing processes of Sensor, the typical data or calculated correlations of technical parameters can only reflect statistical figures. These do not necessarily correspond to the actual parameters of each single product, which could differ from the typical data and calculated correlations or the typical characteristic line. If requested, e.g. because of technical improvements, these typ. data will be changed without any further notice.

Terms of delivery and rights to change design reserved. Due to technical requirements components may contain dangerous substances. For information on the types in question please contact our Sales Organization.

Packing

Please use the recycling operators known to you. We can also help you – get in touch with your nearest sales office. By agreement we will take packing material back, if it is sorted. You must bear the costs of transport. For packing material that is returned to us unsorted or which we are not obliged to accept, we shall have to invoice you for any costs incurred.

Components used in life-support devices or systems must be expressly authorized for such purpose! Critical components¹, may only be used in life-support devices or systems² with the express written approval of OSRAM OS.

¹ A critical component is a component used in a life-support device or system whose failure can reasonably be expected to cause the failure of that life-support device or system, or to affect its safety or effectiveness of that device or system.

² Life support devices or systems are intended (a) to be implanted in the human body, or (b) to support and/or maintain and sustain human life. If they fail, it is reasonable to assume that the health of the user may be endangered.

EU RoHS and China RoHS compliant product



此产品符合欧盟 RoHS 指令的要求；

按照中国的相关法规和标准，不含有毒有害物质或元素。