

The DEC (Digital EC Controller) is a 1-quadrant amplifier for controlling electronically commutated (brushless) DC motors.

- Digital speed control
- Maximum speed: 120 000 rpm (motor with 1 pole pair)
- Operates as speed control, current control or open loop speed control
- /Brake, direction and /disable input
- AUX connection: adjustable function (+5 V output or input for changing speed)
- Status indicator with red and green LED
- Set value input through built-in potentiometer (several speed ranges can be selected) or through analogue set value input (0 ... +5 V)
- Maximum current limit adjustable
- Gain can be adjusted in two stages
- Adjustable speed ramp
- Protection against heat overload
- Blockage protection (current limit for blocked motor)
- Plug-in terminal clamp



## Table of Contents

1	Safety Instructions .....	2
2	Performance Data .....	3
3	Minimum External Wiring for Different Modes of Operation.....	4
4	Operating Instructions .....	6
5	Inputs and Outputs .....	8
6	Switch Functions .....	12
7	Speed Ranges.....	12
8	Potentiometer Functions.....	13
9	Operating Status Display.....	14
10	Protection .....	15
11	EMC-compliant installation .....	15
12	Block Diagram .....	16
13	Dimension Drawing .....	16

The latest edition of these operating instructions may be found in the internet as a PDF-file under [www.maxonmotor.com](http://www.maxonmotor.com) category "Service & Downloads", Order number 230572.

# 1 Safety Instructions

**Skilled Personnel**

Only experienced, skilled personnel should install and start the equipment.

**Statutory regulations**

The user must ensure that the amplifier and the components belonging to it are assembled and connected according to local statutory regulations.

**Load disconnected**

For initial operation, the motor should be free running, i.e. with the load disconnected.

**Additional safety equipment**

Any electronic apparatus is, in principle, not fail-safe. Machines and apparatus must therefore be fitted with independent monitoring and safety equipment. If the equipment breaks down, if it is operated incorrectly, if the control unit breaks down or if the cables break, etc., it must be ensured that the drive or the complete apparatus is kept in a safe operating mode.

**Repairs**

Repairs may only be carried out by authorised personnel or the manufacturer. It is dangerous for the user to open the unit or carry out any repairs.

**Danger**

Ensure that no apparatus is connected to the electrical supply during installation of the DEC 50/5. After switching on, do not touch any live parts!

**Max. supply voltage**

Make sure that the supply voltage is between 10 and 50 VDC. Voltages higher than 60 VDC or of wrong polarity will destroy the unit.

**Short circuit and earth fault**

The amplifier is not protected against:  
winding short circuits, winding short circuits against ground safety earth or Gnd!

**Electrostatic sensitive device (ESD)**

## 2 Performance Data

### 2.1 Electrical data

Supply voltage $V_{CC}$ (Ripple < 5 %)	10 - 50 VDC
Max. output voltage	$0.95 \cdot V_{CC}$
Continuous output current $I_{cont}$	5 A
Max. output current $I_{max}$	10 A
Switching frequency	39 kHz
Max. speed (motor with 1 pole pair)	120 000 rpm

### 2.2 Inputs

Speed	analogue input (0 ... 5 V) Resolution: 1024 steps
/Disable	TTL, CMOS (5V) or switch against Gnd
Direction	TTL, CMOS (5V) ) or switch against Gnd
/Brake	TTL, CMOS (5V) ) or switch against Gnd
Hall sensor	1, 2, 3

### 2.3 Inputs / outputs

AUX (configurable)	digital input / +5 VDC output
--------------------	-------------------------------

### 2.4 Voltage outputs

Hall sensors supply voltage $V_{CC}$ Hall	7 ... 12 VDC, max. 30 mA
---	--------------------------

### 2.5 Motor connections

Motor winding 1
Motor winding 2
Motor winding 3

### 2.6 Trim potentiometers

Speed 1, Speed 2 / Ramp, $I_{max}$ , gain
---

### 2.7 LED indicator

Operating indicator: green LED
Error indicator: red LED

### 2.8 Ambient temperature / humidity range

Operation	-10 ... +45°C
Storage	-40 ... +85°C
No condensation	20 ... 80 %

### 2.9 Protective functions

Heat monitoring of power stage	$T > 100^{\circ}\text{C}$
Blockage protection	Motor current limit, if motor shaft is blocked for longer than 1.5 s

### 2.10 Mechanical data

Weight	approx. 155 g
Dimensions (L x W x H)	see dimension drawing, <a href="#">chapter 13</a>
Mounting plate	for 4 screws M3
Mounting hole separation	87 x 39 mm

### 2.11 Terminals

PCB clamps (plug-in terminal clamps)	15 poles
Pitch	3.5 mm
suitable for wire cross section	0.14...1mm <sup>2</sup> multiple-stranded or 0.14...1.3mm <sup>2</sup> single wire AWG 16-26

### 3 Minimum External Wiring for Different Modes of Operation

#### 3.1 Speed control

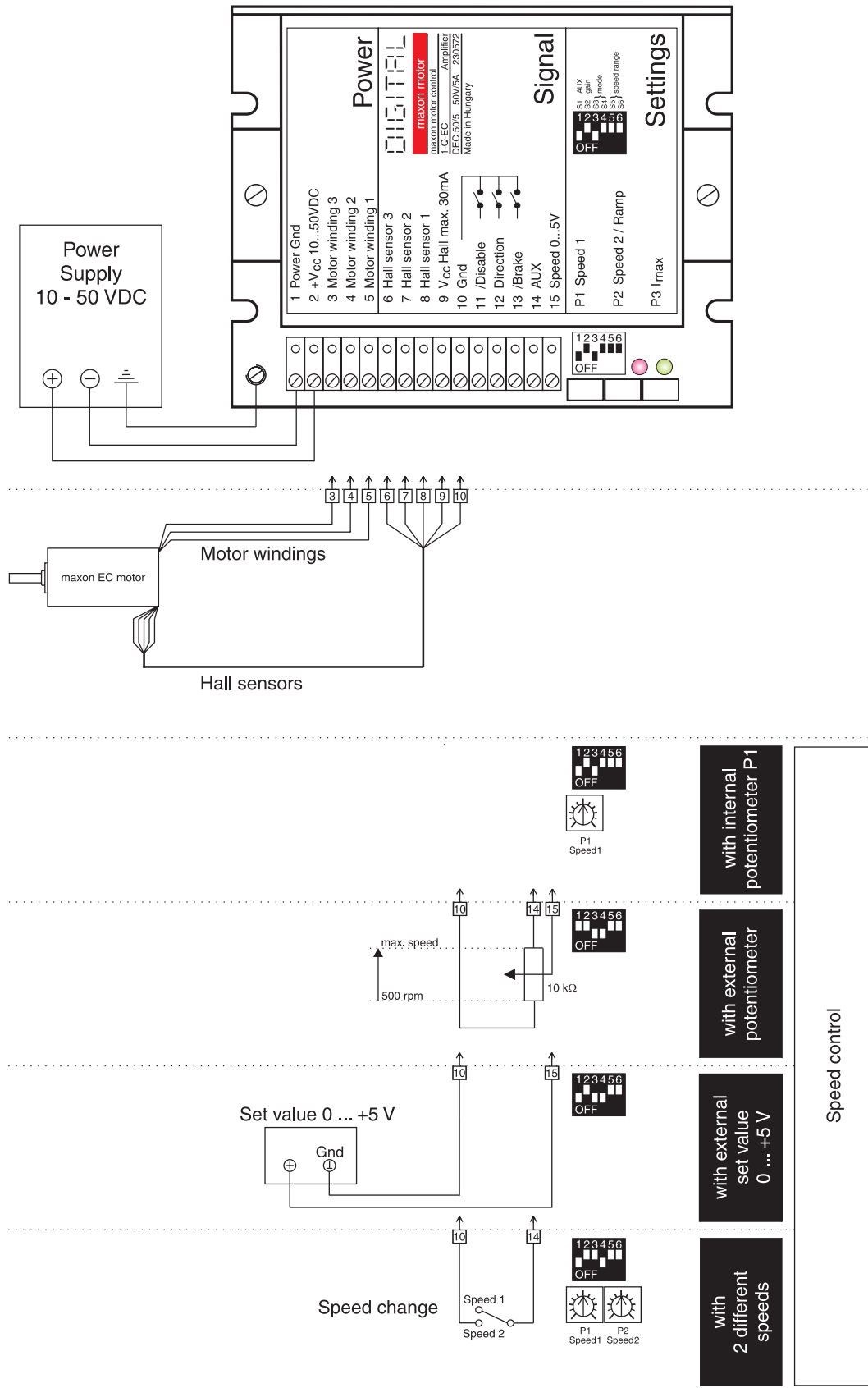

### 3.2 Current control and open loop speed control

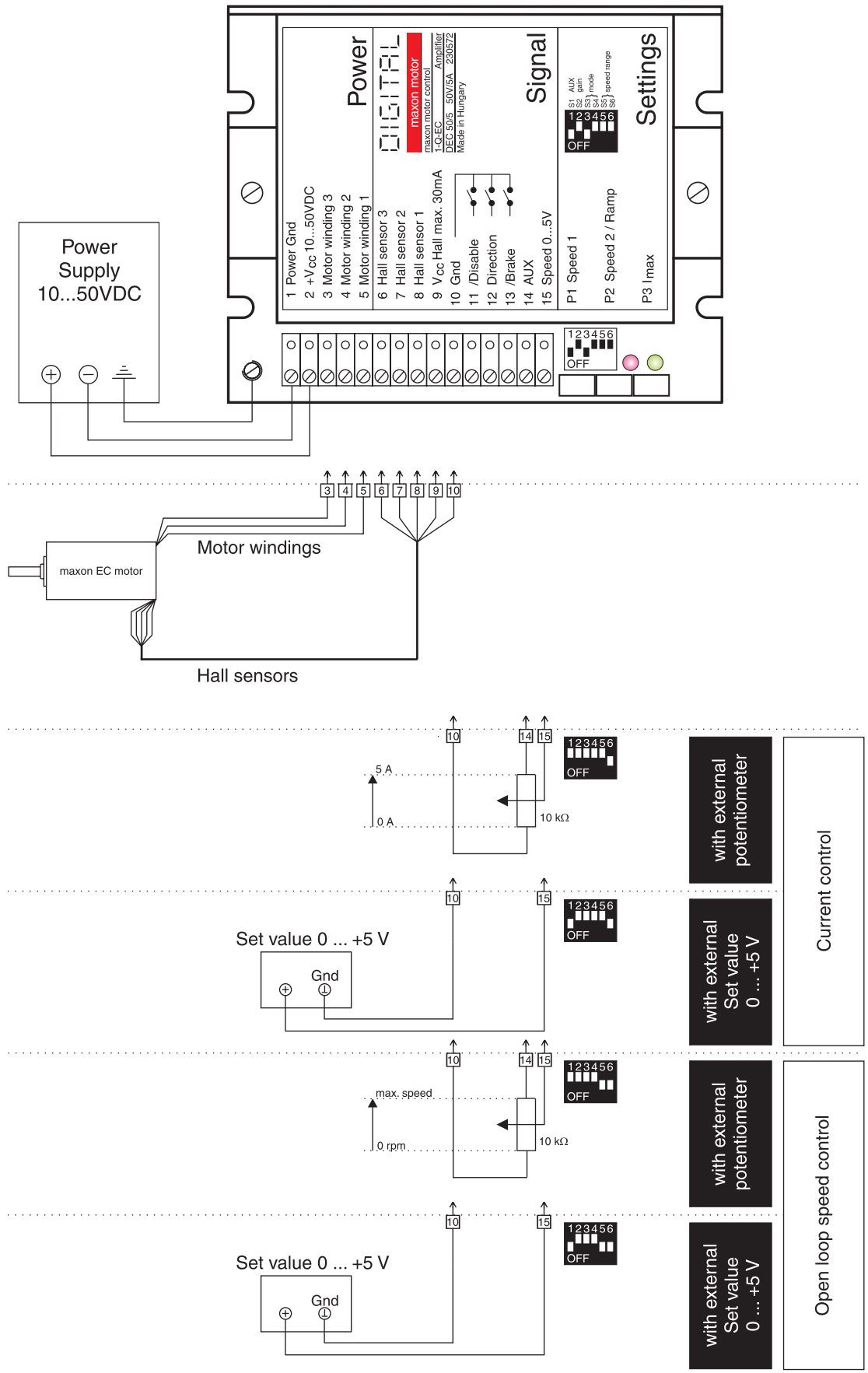

## 4 Operating Instructions

### 4.1 Power supply layout

Any available power supply can be used, as long as it meets the minimum requirements set out below.

During set up and adjustment phases, we recommend separating the motor mechanically from the machine to prevent damage from uncontrolled motion.

#### Power supply requirements

Output voltage	$V_{CC}$ min. 10 VDC; $V_{CC}$ max. 50 VDC
Ripple	< 5 %
Output current	depending on load, continuous max. 5 A acceleration, short-time max. 10 A

The required voltage can be calculated as follows:

#### Known values

- ⇒ Operating torque  $M_B$  [mNm]
- ⇒ Operating speed  $n_B$  [rpm]
- ⇒ Nominal motor voltage  $U_N$  [V]
- ⇒ Motor no-load speed at  $U_N$ ,  $n_0$  [rpm]
- ⇒ Speed/torque gradient of motor  $\Delta n/\Delta M$  [rpm/mNm]

#### Sought values

- ⇒ Supply voltage  $V_{CC}$  [V]

#### Solution

$$V_{CC} = \frac{U_N}{n_0} \cdot \left( n_B + \frac{\Delta n}{\Delta M} \cdot M_B \right) \cdot \frac{1}{0.95} + 1V$$

Choose a power supply capable of supplying this calculated voltage under load. The formula takes into account a max. PWM cycle of 95 % and a 1 volt max. voltage drop at DEC 50/5.

#### Note

Please note [chapter 5.1.5, "/Brake" function](#) when using the "/brake" input!

## 4.2 Adjusting the potentiometers

### 4.2.1 Pre-adjustment

With the pre-adjustment, the potentiometers are set in a preferred position.

DEC units in the original packing are already pre-set.

Pre-adjustment of potentiometers		
<b>P1</b>	Speed 1	50 %
<b>P2</b>	Speed 2 / Ramp	50 %
<b>P3</b>	$I_{\max}$	50 %

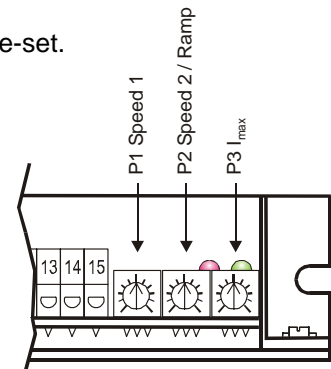

#### Note

Left end stop of potentiometers: Minimum value

Right end stop of potentiometers: Maximum value

### 4.2.2 Adjustment

#### Digital speed control

- Depending on operating mode selected, predetermine set value so that required speed is reached. If necessary, adjust max. speed with switch **S5** and **S6** (see [chapter 7, "Speed Ranges"](#)).
- Adjust potentiometer **P3**  $I_{\max}$  to required limiting value. Maximum current in the 0 ... 10 A range can be adjusted in linear fashion with potentiometer **P3**.
- Adjust switch **S2** gain to required amplification (**S2** OFF: gain high, **S2** ON: gain low)  
**Important:** If the motor is unsteady, vibrates or makes noises, the selected amplification is too high. Switch **S2** must be set at ON.

#### Digital current control

- Adjust potentiometer **P1** Speed 1 to required speed limit. Maximum speed in the 500 ... 25 000 rpm range (motor with 1 pole pair) can be adjusted in linear fashion with potentiometer **P1**, and is independent of the position of the switches **S5** and **S6** (see [chapter 7, "Speed Ranges"](#)).
- Predetermine set value at "Speed" input so that required torque is reached.

#### Note

A set value in the 0 ... 5 V range at the "Speed" input is equal to a current adjustment range of approx. 0 ... 5 A.

Band width of current control: approx. 15 Hz

#### Digital open loop speed control

- Predetermine set value at "Speed" input so that required speed is reached. The set value range of 0 ... +5 V is equal to a motor voltage range of 0 V ...  $V_{CC}$ . The maximum speed is determined by the supply voltage and the speed constant of the motor and is independent of the position of the switches **S5** and **S6**.
- Adjust potentiometer **P3**  $I_{\max}$  to required limiting value. Maximum current in the 0 ... 10 A range can be adjusted in linear fashion with potentiometer **P3**.

## 5 Inputs and Outputs

### 5.1 Inputs

#### 5.1.1 Set value “Speed”

The analogue set value is predetermined at the “Speed” input.

The set value input is used for the following operating modes: speed control, current control and open loop speed control.

The “Speed” input is protected against overvoltage.

Input voltage range	0 ... +5 V (ref: Gnd)
Input impedance	> 1 M $\Omega$ (in the 0 ... +5 V range)
Continuous overvoltage protection	-50 ... +50 V

#### Use of external potentiometer

When using an external potentiometer, the AUX output (switch **S1** AUX ON) can be used as +5 V reference.

Recommended resistance value of potentiometer: 10 k $\Omega$

#### Note

0 V equals the minimum speed (see [chapter 7, “Speed Ranges”](#))

#### 5.1.2 “/Disable”

Disabling or blocking the power stage.

If the input is not wired or the applied voltage is greater than 2.4 V, the amplifier is activated. A speed ramp will be performed during acceleration.

If the input is placed at Gnd-potential or the applied voltage is lower than 0.8 V, the power stage is blocked and the motor shaft freewheels and slows down.

The “/Disable” input is protected against overvoltage.

Input voltage range	0 ... +5 V
Input impedance	33 k $\Omega$ pull-up resistor at +5 V
Continuous overvoltage protection	-50 ... +50 V
Delay time	approx. 12 ms

“/Disable” active	Input open or input voltage > 2.4 V
“/Disable” inactive	Set input to Gnd or input voltage < 0.8 V

#### Note

If the switch adjuster was changed, the new settings are adopted through a disable-enable procedure.



### 5.1.3 “Direction”

When the level changes, the motor slows down in an uncontrolled fashion (as windings are short-circuited, see also [chapter 5.1.5, “/Brake” function](#)) and accelerates in the opposite direction, until the nominal speed is reached again. A speed ramp is only used during acceleration. The “Direction” input is protected against overvoltage.

Input voltage range	0 ... +5 V
Input impedance	33 kΩ pull-up resistor at +5 V
Continuous overvoltage protection	-50 ... +50 V
Delay time	approx. 12 ms

Clockwise (CW)	Input open or input voltage > 2.4 V
Counter-clockwise (CCW)	Set input to Gnd or input voltage < 0.8 V



If the direction is changed with a rotating motor shaft, the limitations described in [chapter 5.1.5, “/Brake” function](#) must be observed, or the amplifier may be damaged.

### 5.1.4 Ramp function

The ramp function enables the motor speed to have a controlled run-up when it starts up and if set values change.

Acceleration time is adjusted at the potentiometer **P2** Ramp and relates to the maximum speed in the currently chosen speed range (see [chapter 7, “Speed Ranges”](#)).

adjustable acceleration time on the potentiometer P2 Ramp	approx. 20 ms ... approx. 10 s
Left end stop	approx. 20 ms
Right end stop	approx. 10 s
Pitch	linear approx. 1.0 s/pitch

Example:

Potentiometer **P2** Ramp: 40 %

Change in “Speed” set value: 0 V to 3 V

Acceleration time to rated speed

$$\text{Acceleration time} = \frac{3 \text{ V}}{5 \text{ V}} \cdot 40 \% \cdot 10 \text{ s} = \text{approx. } 2.4 \text{ s}$$

#### Note

The minimum acceleration time can only be reached if the gain is high and the drive sufficiently dynamic.

### 5.1.5 “/Brake” function

If the input is not wired or the applied voltage is greater than 2.4 V, the /brake function is deactivated.

If the input is placed at Gnd-potential or the applied voltage is lower than 0.8 V, the /brake function is activated and the motor shaft slows down to a halt, short-circuiting the motor windings. The motor windings remain short-circuited until the /brake function is deactivated.

The /brake function is also used with an active /disable function.

The “/Brake” input is protected against overvoltage.

Input voltage range	0 ... +5 V
Input impedance	33 kΩ pull-up resistor at +5 V
Continuous overvoltage protection	-50 ... +50 V
Max. brake current	30 A
Delay time	approx. 12 ms

“/Brake” inactive	Input open or input voltage > 2.4 V
“/Brake” active	Set input to Gnd or input voltage < 0.8 V.

The maximum permitted brake speed is limited by the maximum permitted short-circuit current and maximum kinetic energy:

- $I \leq 30 \text{ A}$
- $W_k \leq 20 \text{ Ws}$

the values can be calculated as follows:

The maximum permitted brake speed can be calculated from the motor data:

$$n_{\max} = 30 \text{ A} \cdot k_n \cdot (R_{ph-ph} + 0.05 \Omega) \quad [rpm]$$

$k_n$  = Speed constant [rpm/V]

$R_{Ph-Ph}$  = Terminal resistance phase-phase [ $\Omega$ ]

With the given moment of inertia, the maximum speed can be determined using the following formula:

$$n_{\max} = \sqrt{\frac{365}{J_R + J_L}} \cdot 10\,000 \quad [rpm]$$

$J_R$  = Rotor inertia [ $\text{g}\cdot\text{cm}^2$ ]

$J_L$  = Load inertia [ $\text{g}\cdot\text{cm}^2$ ]



max. permitted brake  
speed limited by brake  
current  
( $I = 30 \text{ A}$ )



max. permitted brake  
speed limited by kinetic  
energy ( $W_k = 20 \text{ Ws}$ )

### 5.1.6 "AUX"

The "AUX" terminal can be used as input or output, depending on the switch position.

The "AUX" terminal is only protected against overvoltage if switch **S1** is open.

Switch S1 closed	Function	Voltage output
	Output voltage	+5 VDC $\pm$ 5 %
	Internal resistance	220 $\Omega$
	Output current, designed for an external potentiometer $\geq 10$ k $\Omega$	500 $\mu$ A
Switch S1 opened	Function	Speed change
	Input voltage range	0 ... +5 V
	Input impedance	33 k $\Omega$ pull-up resistor at +5 V
	Continuous overvoltage protection	-50 ... +50 V
	Speed setting with potentiometer Speed 1	Input open or input voltage > 4.0 V
	Speed setting with potentiometer Speed 2	Set input to Gnd or input voltage < 1.0 V

### 5.1.7 "Hall sensor 1", "Hall sensor 2", "Hall sensor 3"

Hall sensors are needed for detecting rotor position.

"Hall sensor" inputs are protected against overvoltage.

Input voltage range	0 ... +5 V
Input impedance	15 k $\Omega$ pull-up resistor at +5 V
Voltage value "low"	max. 0.8 V
Voltage value "high"	min. 2.4 V
Continuous overvoltage protection	-50 ... +50 V

Suitable for Hall effect sensors IC using Schmitt trigger and open collector output.

## 5.2 Outputs

### 5.2.1 "V<sub>CC</sub> Hall"

Powering the Hall sensors.

Output voltage	7 ... 12 VDC
Max. output current	30 mA (current limited)

## 6 Switch Functions

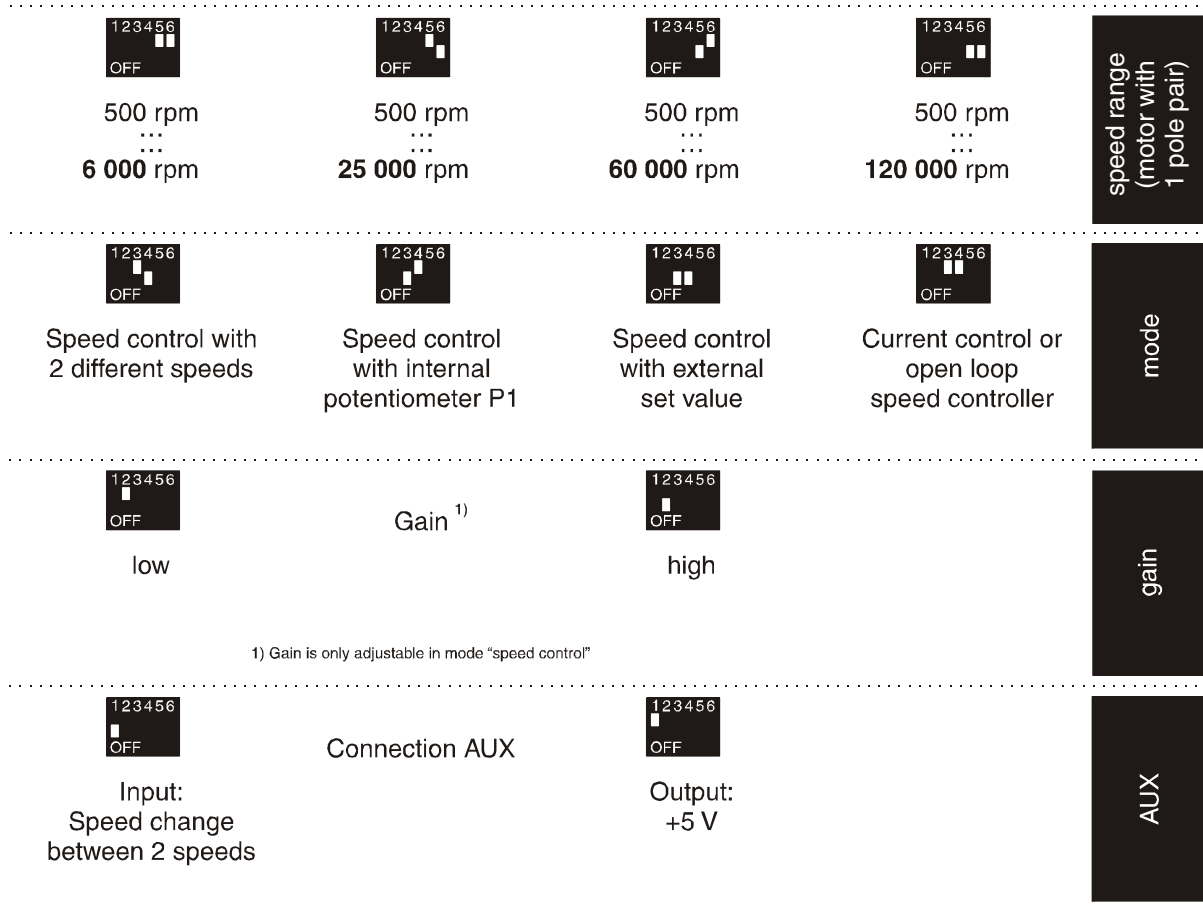

## 7 Speed Ranges

In the **speed control mode** the set value range (0 ... +5 V) is equal to the following speed ranges:





Switch S5 and S6	Type of motor		
	Motor with 1 pole pair	Motor with 4 pole pairs	Motor with 8 pole pairs
OFF	500 ... 6 000 rpm	125 ... 1 500 rpm	67 ... 750 rpm
OFF	500 ... 25 000 rpm	125 ... 6 250 rpm	67 ... 3 125 rpm
OFF	500 ... 60 000 rpm	125 ... 15 000 rpm	67 ... 7 500 rpm
OFF	500 ... 120 000 rpm	125 ... 30 000 rpm	67 ... 15 000 rpm

### Note

- Independent of the position of the switches **S5** and **S6**, the maximum speed can, with the help of **P1 Speed**, be adjusted only in the range 500 ... 25 000 rpm (2 pole motors) in current control mode. For multi-pole motors the speed range is shown in the table above.
- Operating as an open loop speed control the 0 V set value is equal to a motor voltage of 0 V and thus a speed of 0 rpm. Independent of the position of the switches **S5** and **S6**, the maximum speed is given by the supply voltage and the speed constant of the motor.



## 8 Potentiometer Functions

The following table shows which potentiometer is active in which operating mode.

Function of potentiometers	Mode							
	Speed control (closed loop)				Current control		Open loop speed control	
	Set value with internal potentiometer P1	Set value with external potentiometer	With external set value 0 ... +5 V	With 2 different speeds	Set value with external potentiometer	With external set value 0 ... +5 V	Set value with external potentiometer	With external set value 0 ... +5 V
 P1 Speed1	✓			✓	✓	✓		
 P2 Speed2				✓				
 P2 Ramp	✓	✓	✓					
 P3 I <sub>max</sub>	✓	✓	✓	✓			✓	✓

## 9 Operating Status Display

Red and green LEDs show the operating status.



Definition	
	LED on
	LED off

### 9.1 No LED

Reason:

- No supply voltage
- Fuse blown
- Wrong polarity of supply voltage
- Hall sensors supply voltage  $V_{CC}$  Hall is short-circuited

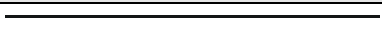
### 9.2 Green LED

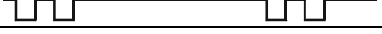
Flashing type (green LED)	Operating status
 LED on	Amplifier active
	/Disable function active
	/Brake function active

### 9.3 Red LED flickers or flashes intermittently





The controller recognises invalid conditions in the Hall sensor inputs.

Reason:

- Hall sensors not connected or incorrectly connected
- Intermittent Hall sensor supply lines
- Excessive interference to Hall sensor supply lines  
(Solution: change supply line feeds, use shielded cable)
- Faulty Hall sensors in motor

### 9.4 Red LED flashes regularly

The following error messages can be distinguished depending on flashing type:

Flashing type (red LED)	Error message
	Thermal overload protection is active
	<ul style="list-style-type: none"> <li>• Motor shaft is blocked</li> <li>• Load too great</li> <li>• <math>I_{max}</math> setting too low</li> <li>• No winding connection</li> </ul>
	When switched on, the controller recognises invalid conditions in the Hall sensor inputs => check Hall sensor wiring and Hall sensor signals
	An invalid operating mode was set on switches <b>S3-S6</b>

## 10 Protection

### 10.1 Protection against heat overload

If the power stage temperature exceeds a limit of around 100°C for longer than 1.5 s, the output stage is switched off.

The error mode is shown in diagram form (see [chapter 9 “Operating Status Display”](#)).

If the power stage temperature falls below 80°C, the motor is restarted. A speed ramp will be performed during acceleration.

### 10.2 Blockage protection

If the motor shaft is blocked for longer than 1.5 s, the current limit is set at 4.2 A, provided the current limit was not set at a lower value via the  $I_{max}$  potentiometer.

#### Note

The blockage protection is not active in current control mode.

## 11 EMC-compliant installation

#### Power supply (+V<sub>CC</sub> - Power Gnd)

- No shielding normally required.
- Star point-shaped wiring if several amplifiers are supplied by the same power supply.

#### Motor cable (> 30 cm)

- Shielded cable highly recommended.
- Connect shielding on both sides:
 

DEC 50/5 side:	Bottom of housing.
Motor side:	Motor housing or with motor housing mechanical design with low resistive connection.
- Use separate cable.

#### Hall sensor cable (> 30 cm)

- Shielded cable highly recommended.
- Connect shielding on both sides:
 

DEC 50/5 side:	Bottom of housing.
Motor side:	Motor housing or with motor housing mechanical design with low resistive connection.
- Use separate cable.

#### Direct connection motor/Hall cable (≤ 30 cm) on DEC 50/5

- Shield casing over motor/Hall connection cable
- Connect shielding on both sides
- or
- Lowest resistive connection of motor housing and bottom of DEC 50/5 housing
- Cable design of motor/Hall connection cable as close as possible with aforementioned connection

#### Analogue signals (AUX, Speed)

- No shielding normally required
- Use cable shielding with analogue signals with small signal level and electromagnetically harsh environment
- Normally connect shielding on both sides. Place shielding on one side if there are 50/60 Hz interference problems.

#### Digital signals (Disable, Direction, Brake)

- No shielding necessary.

See also block diagram in [chapter 12](#).

**In practical terms, only the complete equipment, comprising all individual components (motor, amplifier, power supply unit, EMC filter, cabling etc.) can undergo an EMC test to ensure interference-free CE-approved operation.**

### 12 Block Diagram

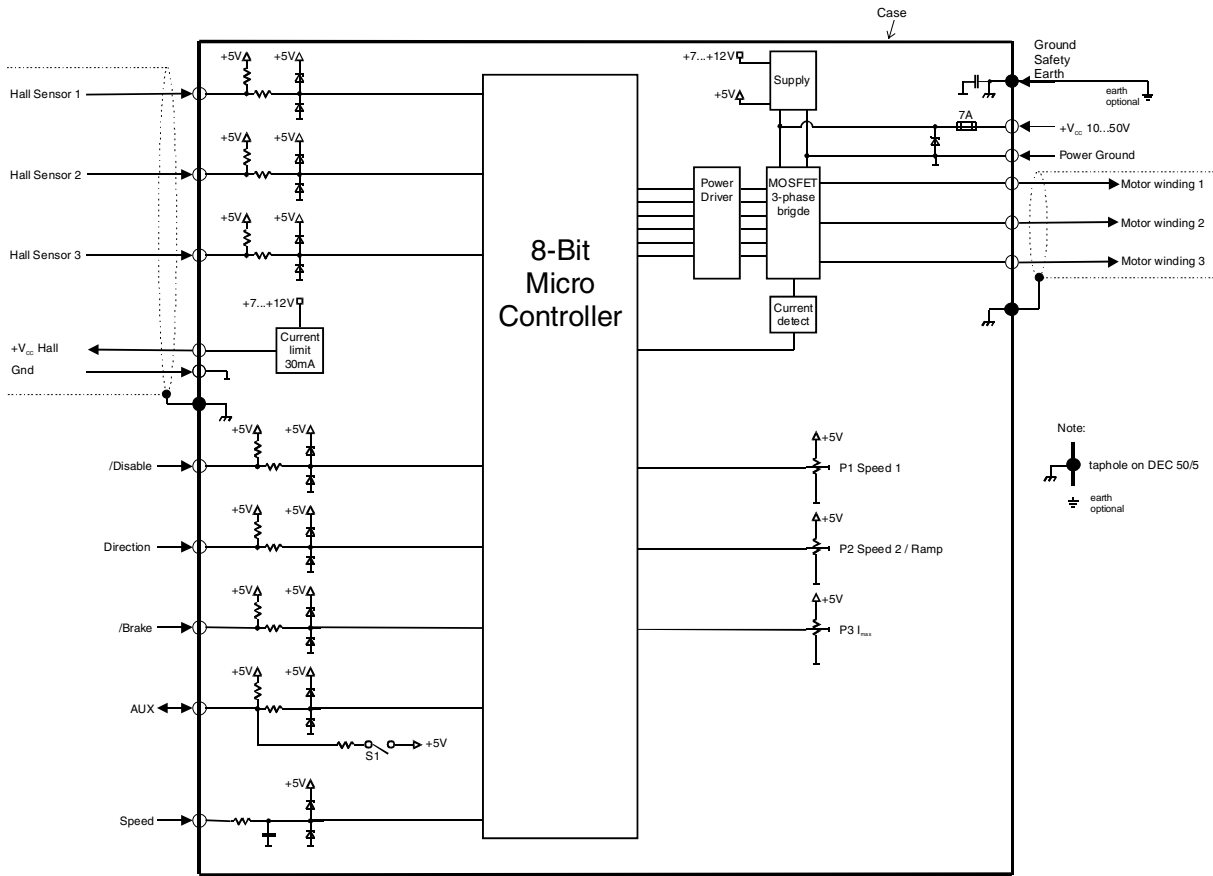

### 13 Dimension Drawing

Dimensions in [mm]

