

Solid-state Timer

New H3Y

Miniature Timer Compatible with the MY Relay

- Semi-multi power supply voltage.
- Large transparent time setting knob facilitates time setting. A flat-blade and Phillips screwdriver can also be used for time setting.
- Pin configuration compatible with MY Power Relay.
- LED indication for power and output statuses.
- Conforms to EMC standards.
- Conforms to VDE0435/P2021 and approved by UL and CSA.



Ordering Information

Operation/resetting system	Time-limit contact	Time ranges	Supply voltage	Mounting	
				Surface /DIN-track mounting (with socket)	Surface mounting (with PCB terminals)
Time-limit operation/self-resetting	DPDT (for power switching)	0.04 s to 3 h	24, 100 to 120, 200 to 230 VAC (50/60 Hz); 12, 24, 48, 125, 100 to 110 VDC	H3Y-2	H3Y-2-0
	4PDT			H3Y-4	H3Y-4-0

Note: Specify both the model number, supply voltage, and rated time when ordering.

Ex. H3Y-2 100 to 120 VAC 0.5 s

└──────────────────┘ └──┘

Supply voltage Rated time

■ Accessories (Order Separately)

Timer	Track mounted socket (see note 1)	Back connecting socket		
		Solder terminal	Wire-wrap terminal	PC terminal
H3Y-2	PYF08A, PYF08A-N	PY08	PY08QN(2)	PY08-02
H3Y-4	PYF14A, PYF14A-N	PY14	PY14QN(2)	PY14-02

Note: Track mounted socket can be used as a front connecting socket.

Specifications

■ Time Ranges

Rated time	Time setting range	Rated time	Time setting range
0.5 s	0.04 to 0.5 s	3 min	0.1 to 3 min
1 s	0.1 to 1 s	5 min	0.2 to 5 min
5 s	0.2 to 5 s	10 min	0.5 to 10 min
10 s	0.5 to 10 s	30 min	1 to 30 min
30 s	1.0 to 30 s	60 min	2 to 60 min
60 s	2.0 to 60 s	3 h	0.1 to 3 h
120 s	5.0 to 120 s	---	---

■ Ratings

Item	H3Y-2(-0)/H3Y-4(-0)
Rated supply voltage	24, 100 to 120, 200 to 230 VAC (50/60 Hz), 12, 24, 48, 125, 100 to 110 VDC (see note 1)
Operating voltage range	All rated voltages except 12 VDC: 85% to 110% of rated supply voltage 12 VDC: 90% to 110% of rated supply voltage (see note 2)
Power consumption	24 VAC: Relay ON: 1.5 VA (1.1 W) (at 24 VAC, 60 Hz) Relay OFF: 0.2 VA (0.1 W) (at 24 VAC, 60 Hz) 100 to 120 VAC: Relay ON: 1.5 VA (1.3 W) (at 120 VAC, 60 Hz) Relay OFF: 0.8 VA (0.5 W) (at 120 VAC, 60 Hz) 200 to 230 VAC: Relay ON: 1.8 VA (1.5 W) (at 230 VAC, 60 Hz) Relay OFF: 1.2 VA (0.9 W) (at 230 VAC, 60 Hz) 12 VDC: Relay ON: 0.9 W (at 12 VDC) Relay OFF: 0.07 W (at 12 VDC) 24 VDC: Relay ON: 0.9 W (at 24 VDC) Relay OFF: 0.07 W (at 24 VDC) 48 VDC: Relay ON: 1.0 W (at 48 VDC) Relay OFF: 0.2 W (at 48 VDC) 100 to 110 VDC: Relay ON: 1.3 W (at 110 VDC) Relay OFF: 0.3 W (at 110 VDC) 125 VDC: Relay ON: 1.3 W (at 125 VDC) Relay OFF: 0.3 W (at 125 VDC)
Control outputs	H3Y-2(-0): 5 A at 250 VAC, resistive load ($\cos\phi = 1$) H3Y-4(-0): 3 A at 250 VAC, resistive load ($\cos\phi = 1$)

- Note:**
1. With DC ratings, single-phase full-wave rectified power sources may be used.
 2. Use the Timer within 90% to 110% of the rated supply voltage (95% to 110% for 12 VDC) when using it continuously under an ambient operating temperature of 50 °C.
 3. The model designed for a power consumption of 200 to 230 VAC at 50/60 Hz can be used within the permissible voltage fluctuation range of 170 to 230 VAC. Please contact your OMRON representative if models with specifications of 240 VAC, 50/60 Hz (85% to 110%) are required.

■ Characteristics

Accuracy of operating time	±1% FS max. (0.5 s range: ±1%±10 ms max.)
Setting error (see note 1)	±10%±50 ms FS max.
Reset time	Min. power-opening time: 0.1 s max. (including halfway reset)
Reset voltage	10% max. of rated supply voltage
Influence of voltage (see note 1)	±2% FS max.
Influence of temperature (see note 1)	±2% FS max.
Insulation resistance	100 MΩ min. (at 500 VDC)
Dielectric strength	2,000 VAC, 50/60 Hz for 1 min (between current-carrying terminals and exposed non-current-carrying metal parts) (see note 2) 2,000 VAC, 50/60 Hz for 1 min (between operating power circuit and control output) (see note 2) 2,000 VAC, 50/60 Hz for 1 min (between different pole contacts; 2-pole model) (see note 2) 1,500 VAC, 50/60 Hz for 1 min (between different pole contacts; 4-pole model) 1,000 VAC, 50/60 Hz for 1 min (between non-continuous contacts)
Vibration resistance	Destruction: 10 to 55 Hz, 0.75-mm single amplitude Malfunction: 10 to 55 Hz, 0.5-mm single amplitude
Shock resistance	Destruction: 1,000 m/s ² (approx. 100G) Malfunction: 100 m/s ² (approx. 10G)
Ambient temperature	Operating: -10°C to 50°C (with no icing) Storage: -25°C to 65°C (with no icing)
Ambient humidity	Operating: 35% to 85%
Life expectancy	Mechanical: 10,000,000 operations min. (under no load at 1,800 operations/h) Electrical: H3Y-2: 500,000 operations min. (5 A at 250 VAC, resistive load at 1800 operations/h) H3Y-4: 200,000 operations min. (3 A at 250 VAC, resistive load at 1800 operations/h)
Impulse withstand voltage	Between power terminals: 3 kV for 100 to 120 VAC, 200 to 230 VAC, 100 to 110 VDC, 125 VDC 1 kV for 12 VDC, 24 VDC, 48 VDC Between exposed non-current-carrying metal parts: 4.5 kV for 100 to 120 VAC, 200 to 230 VAC, 100 to 110 VDC, 125 VDC 1.5 kV for 12 VDC, 24 VDC, 48 VDC
Noise immunity	±1.5 kV, square-wave noise by noise simulator (pulse width: 100 ns/1 μs, 1-ns rise)
Static immunity	Destruction: 8 kV Malfunction: 4 kV
Enclosure rating	IP40
Weight	Approx. 50 g
EMC	Emission Enclosure: EN55011 Group 1 class A Emission AC Mains: EN55011 Group 1 class A Immunity ESD: EN61000-4-2: 4 kV contact discharge (level 2) 8 kV air discharge (level 3) Immunity RF-interference: ENV50140: 10 V/m (amplitude modulated, 80 MHz to 1 GHz) (level 3) 10 V/m (pulse modulated, 900 MHz) Immunity Conducted Disturbance: ENV50141: 10 V (0.15 to 80 MHz) (level 3) Immunity Burst: EN61000-4-4: 2 kV power-line (level 3) 2 kV I/O signal-line (level 4)
Approved standards	UL508, CSA C22.2 No. 14 Conforms to VDE0435/P2021, VDE0110 (for in-panel use) Conforms to EN50081-2, EN50082-2

- Note:** 1. Add ±10 mS to the above value for the 0.5-S range model.
2. Terminal screw sections are excluded.

Engineering Data

H3Y-2, H3Y-2-0

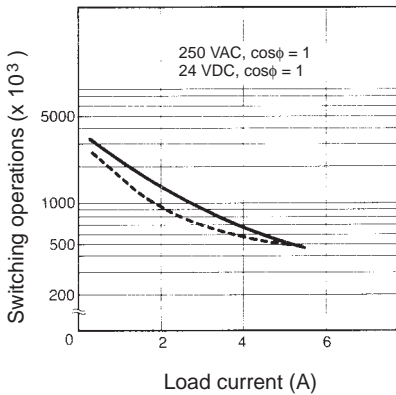

H3Y-2, H3Y-2-0

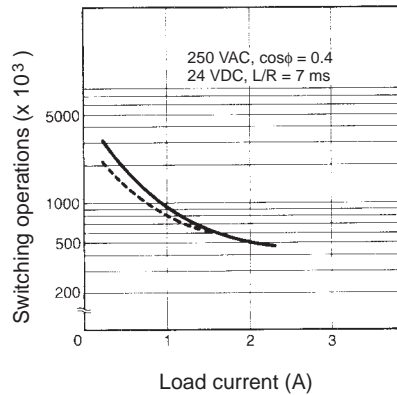

Reference: A maximum current of 0.6 A can be switched at 125 VDC ($\cos\phi = 1$).
 Maximum current of 0.2 A can be switched if L/R is 7 ms. In both cases,
 a life of 100,000 operations can be expected.
 The minimum applicable load is 1 mA at 5 VDC (P reference value).

H3Y-4, H3Y-4-0

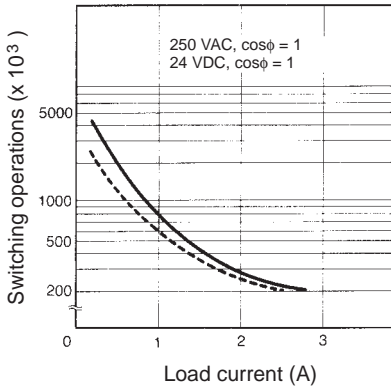

H3Y-4, H3Y-4-0

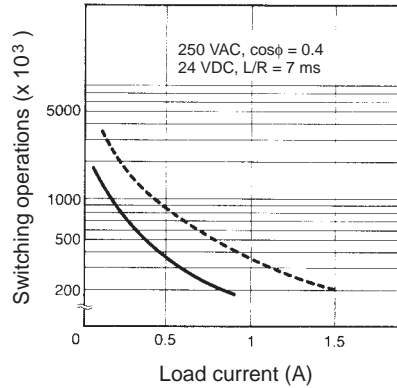

Reference: A maximum current of 0.5 A can be switched at 125 VDC ($\cos\phi = 1$).
 Maximum current of 0.2 A can be switched if L/R is 7 ms. In both cases,
 a life of 100,000 operations can be expected.
 The minimum applicable load is 1 mA at 1 VDC (P reference value).

Operation

■ Timing Chart

H3Y-2, H3Y-2-0

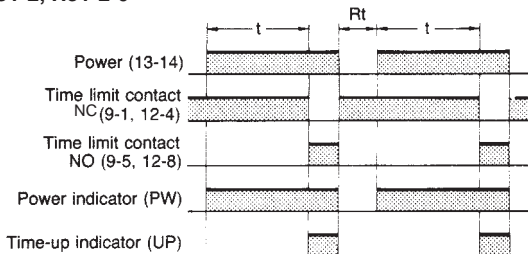

H3Y-4, H3Y-4-0

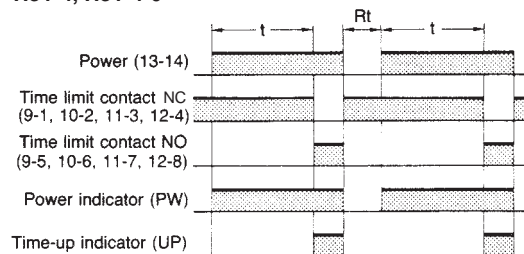

Dimensions

Note: All units are in millimeters unless otherwise indicated.

■ Timers

H3Y-2

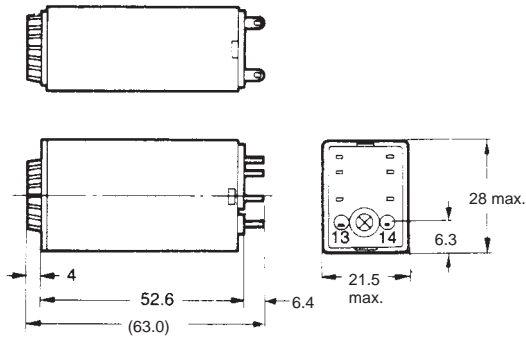

H3Y-4

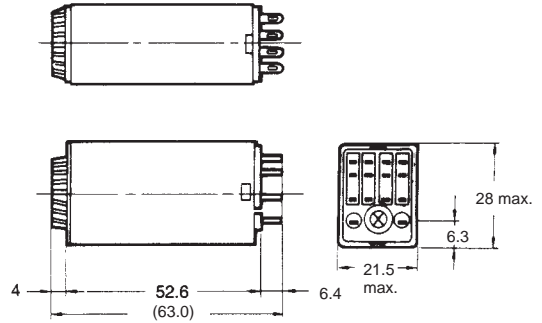

H3Y-2-0

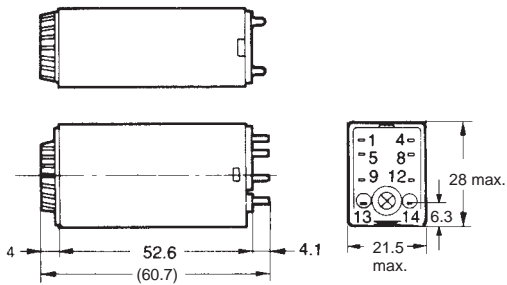

H3Y-4-0, H3Y-4-CB-0

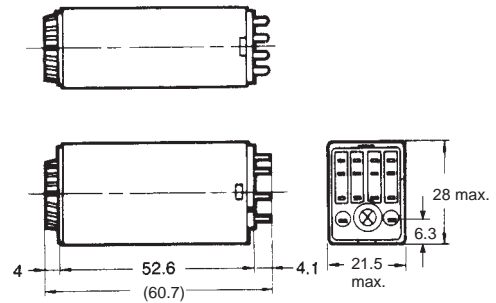

Mounting Holes

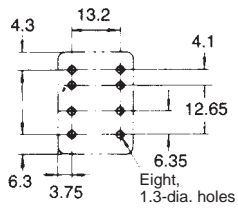

Mounting Holes

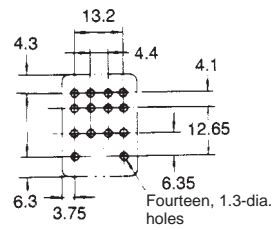

■ Accessories (Order Separately)

Use the PYF□A, PY□, PY□-02, or PY□QN(2) to mount the H3Y. When ordering any one of these sockets, replace “□” with “08” or “14.”

Track Mounting/Front Connecting Sockets

PYF08A

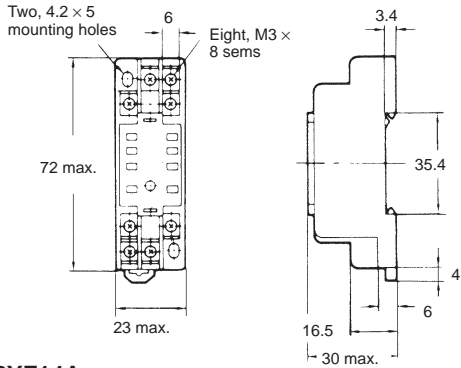

Terminal Arrangement (Top View)

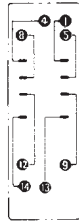

Mounting Holes

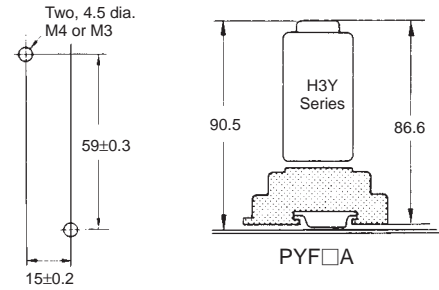

PYF14A

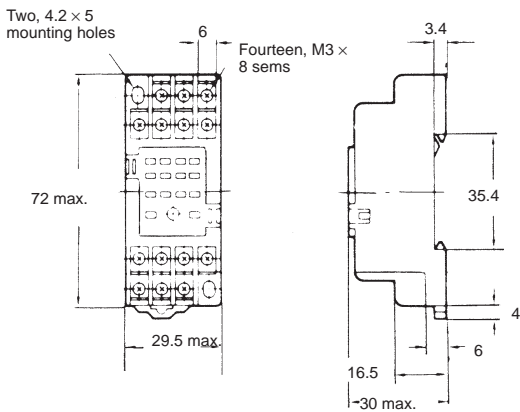

Terminal Arrangement (Top View)

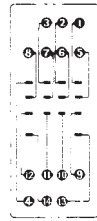

Mounting Holes

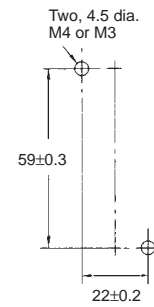

PYF08A-N

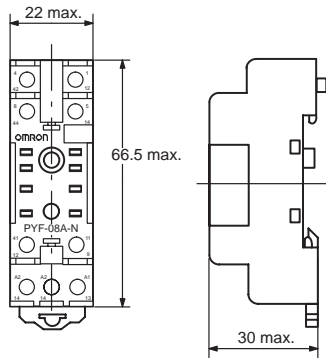

Terminal Arrangement

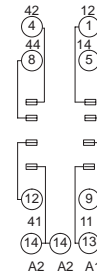

Mounting Holes (for Surface Mounting)

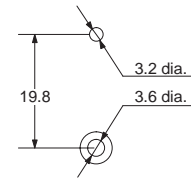

PYF14A-N

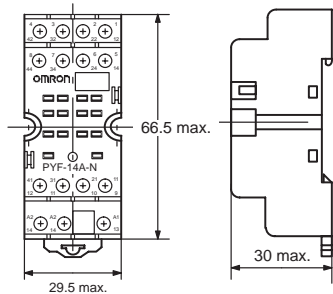

Terminal Arrangement

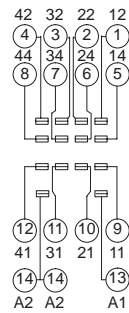

Mounting Holes (for Surface Mounting)

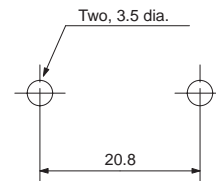

Back Connecting Sockets

PY08, PY14

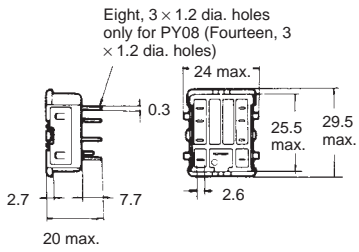

Terminal Arrangement (Bottom View)

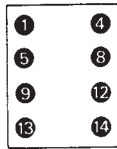

PY08

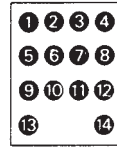

PY14

Panel Cutout

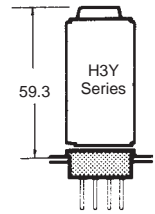
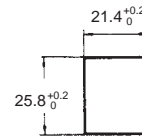

PY□, PY□-02, PY□QN(2)

**PY08QN, PY14QN
PY08QN(2), PY14QN(2)**

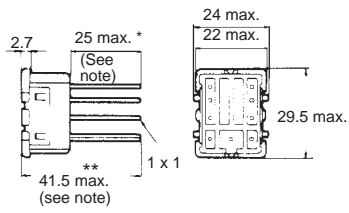

Terminal Arrangement (Bottom View)

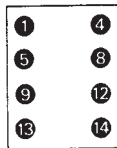

PY08QN
PY08QN(2)

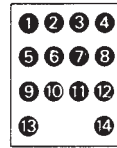

PY14QN
PY14QN(2)

Note: With PY□QN(2), dimension * should read 20 max. and dimension ** 36.5 max.

PY08-02, PY14-02

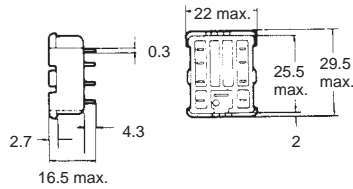

Terminal Arrangement (Bottom View)

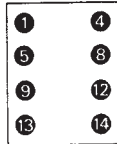

PY08-02

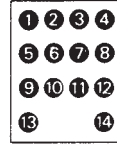

PY14-02

Socket Mounting Plates (t = 1.6)

Applicable socket	For mounting 1 socket	For mounting 18 sockets
PY08, PY14, PY08QN(2), PY14QN(2)	PYP-1	PYP-18

Note: PYP-18 may be cut to any desired length.

PYP-1

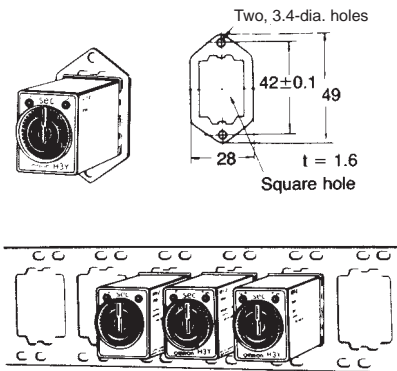

PYP-18

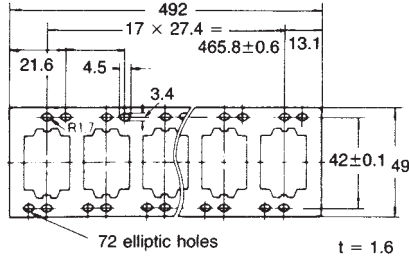

Relay Hold-down Clips

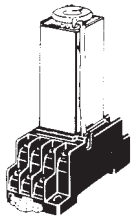

Y92H-3 for PYF□A Socket

Y92H-4 for PY□ Socket

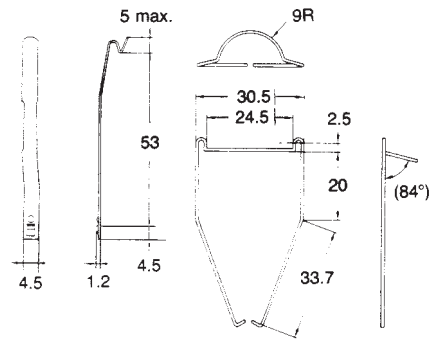

Mounting Track

PFP-100N/PFP-50N (see note 1)

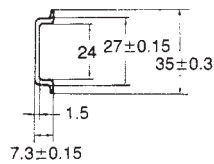
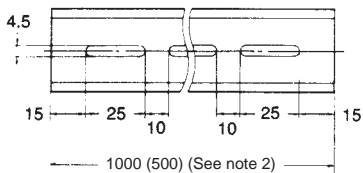

Note: 1. Meets DIN EN50022
2. This dimension applies to PFP-50N.

End Plate

PFP-M

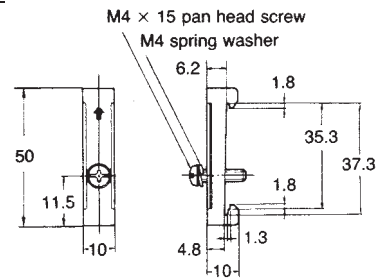

Spacer

PFP-S

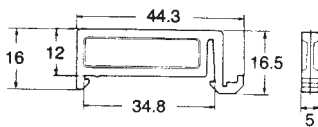

Installation

■ Connection

H3Y-2, H3Y-2-0

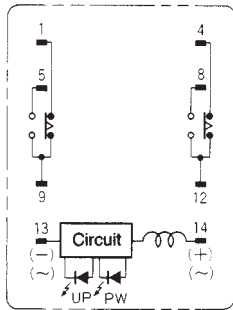

Connect the DC power supply to terminals 13 and 14 according to the polarity marks.

H3Y-4, H3Y-4-0

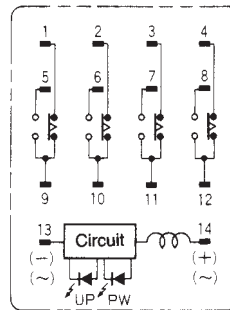

Connect the DC power supply to terminals 13 and 14 according to the polarity marks.

Precautions

When selecting a control output, use the H3Y-2 for switching ON and OFF the power and the H3Y-4 for switching ON and OFF the minute load.

The operating voltage will increase when using the H3Y in any place where the ambient temperature is more than 50°C. Supply 90% to 110% of the rated voltages (at 12 VDC: 95% to 110%) when operating at 50°C or higher.

Do not leave the H3Y in time-up condition for a long period of time (for example, more than one month in any place where the ambient temperature is high), otherwise the internal parts (aluminum electrolytic capacitor) may become damaged. Therefore, the use of the H3Y with a relay as shown in the following circuit diagram is recommended to extend the service life of the H3Y.

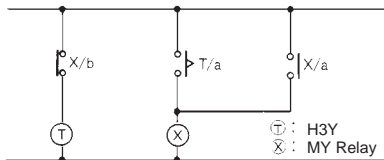

Do not connect the H3Y as shown in the following circuit diagram on the right hand side, otherwise the H3Y's internal contacts different from each other in polarity may become short-circuited.

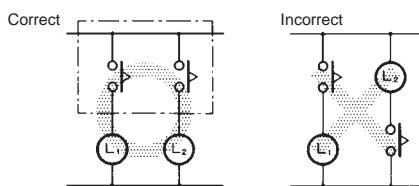

Use the following safety circuit when building a self-holding or self-resetting circuit with the H3Y and an auxiliary relay, such as an MY Relay, in combination.

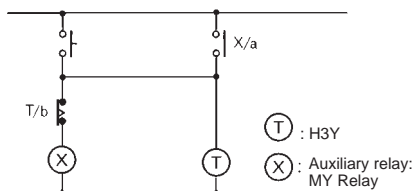

Do not use the H3Y in places where there is excessive dust, corrosive gas, or direct sunlight.

Do not mount more than one H3Y closely together, otherwise the internal parts may become damaged. Make sure that there is a space of 5 mm or more between any H3Y Models next to each other to allow heat radiation.

The internal parts may become damaged if a supply voltage other than the rated ones is imposed on the H3Y. When more than 100 V is applied to 12- or 24-VDC models, the internal element (varistor) may break.

Precautions for VDE Conformance

The H3Y as a built-in timer conforms to VDE 0435/P2021 provided that the following conditions are satisfied.

Handling

Before dismounting the H3Y from the socket, make sure that no voltage is imposed on any terminal of the H3Y.

Wiring

The power supply for the H3Y must be protected with equipment such as a breaker approved by VDE.

Only a load with basic isolation can be connected to the output contact. The H3Y is a model with basic isolation. Therefore, the H3Y and the load will ensure reinforced isolation, thus meeting VDE standards.

Insulation requirement: Overvoltage category II, pollution degree 2 (with a clearance of 1.5 mm and a creepage distance of 2.5 mm at 240 VAC)

Output terminals next to each other on the H3Y-4 or H3Y-4-0 must have the same polarity.

ALL DIMENSIONS SHOWN ARE IN MILLIMETERS.

To convert millimeters into inches, multiply by 0.03937. To convert grams into ounces, multiply by 0.03527.

Cat. No. L24-E1-9 **In the interest of product improvement, specifications are subject to change without notice.**

OMRON Corporation

Systems Components Division
28th Fl., Crystal Tower Bldg.
1-2-27, Shiromi, Chuo-ku,
Osaka 540 Japan
Phone: 06-949-6012 Fax: 06-949-6021

Printed in Japan
0197-2M (0197) a