

A01 SERIES

ILLUMINATED OR NON-ILLUMINATED PUSHBUTTON SWITCHES

Panel cut-out Ø16 (.630)

A pushbutton assembly requires:

screen + lamp (if illuminated) + operator + switchblock
 To order these elements, select desired model numbers from tables below.

Example: IP65 rectangular pushbutton, single pole, maintained, red screen and 12V red LED = A0161B, A0142M1, A0101X and A0151B

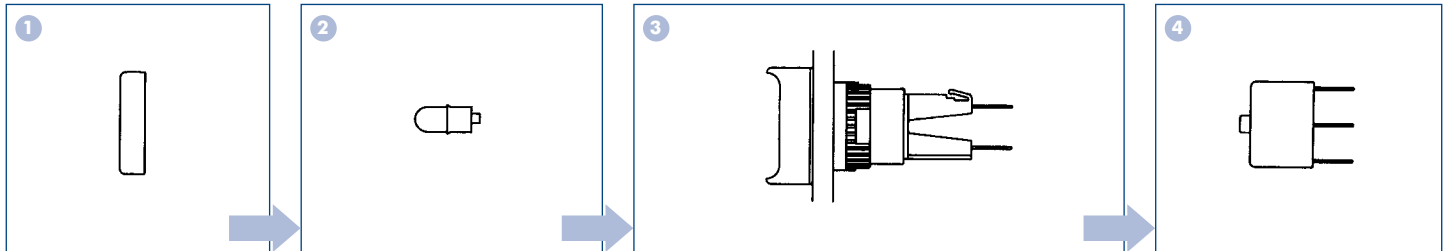
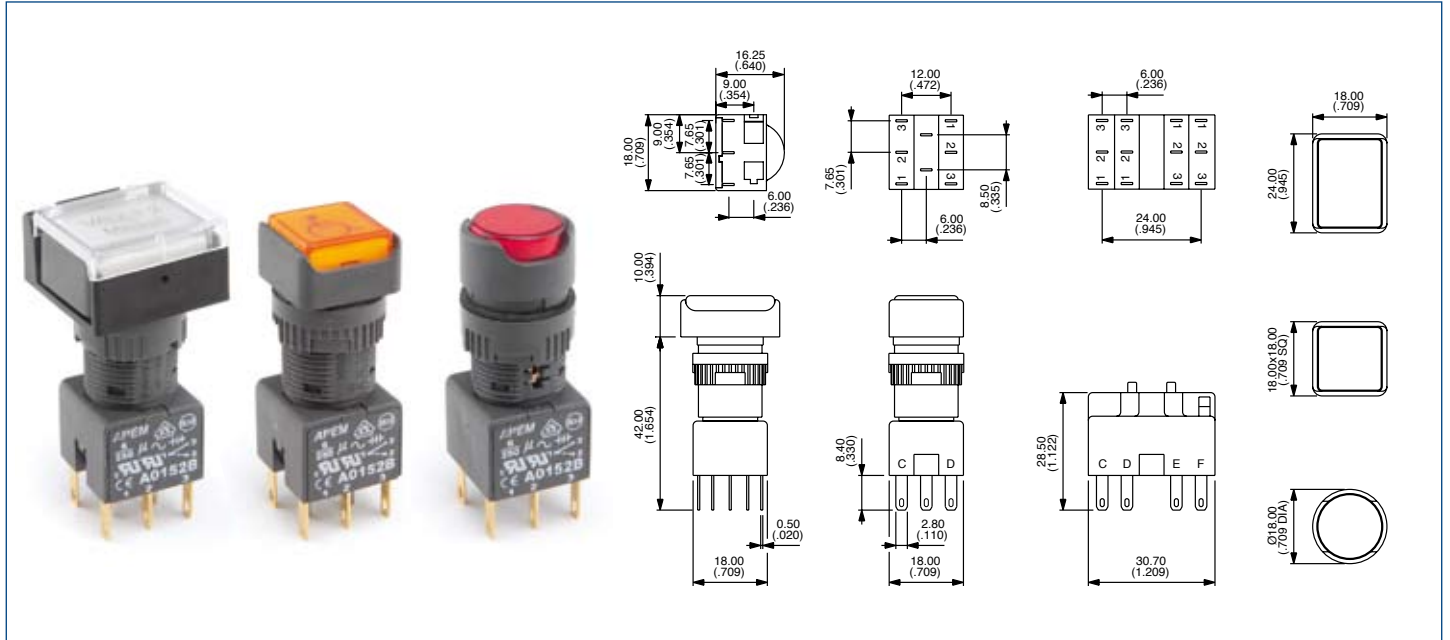
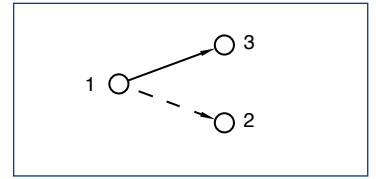

Screen			Lamp			Operator				Switch block	
Bezel	Colour	Part No	Lamp	Voltage	Part No	Pole	Bezel	Description	Part No	No of poles	Part No
□	black	A0161A	Filament	6.3V	A0141A	1 or 2	□	Illum, momentary	A0101Y	Single pole	A0151B
□	red	A0161B	Filament	14V	A0141B	1 or 2	□	Illum, maintained	A0101X	Double pole	A0152B
□	amber	A0161C	Filament	28V	A0141C	1 or 2	□	Non-illum, momentary	A0102Y	Three pole	A0155B
□	yellow	A0161D	Filament	36V	A0141D	1 or 2	□	Non-illum, maintained	A0102X	Four pole	A0153B
□	green	A0161E	Filament	48V	A0141E	3 or 4	□	Illum, momentary	A0103Y		
□	blue	A0161F	Filament	60V	A0141F	3 or 4	□	Illum, maintained	A0103X		
□	clear	A0161G	Neon	110V	A0143G	3 or 4	□	Non-illum, momentary	A0104Y		
□	white	A0161J	Neon	220V	A0143H	3 or 4	□	Non-illum, maintained	A0104X		
□	black	A0162A	LED	6V red	A0142L1	1 or 2	□	Illum, momentary	A0105Y		
□	red	A0162B	LED	6V green	A0142L2	1 or 2	□	Illum, maintained	A0105X		
□	amber	A0162C	LED	6V amber	A0142L3	1 or 2	□	Non-illum, momentary	A0106Y		
□	yellow	A0162D	LED	12V red	A0142M1	1 or 2	□	Non-illum, maintained	A0106X		
□	green	A0162E	LED	12V green	A0142M2	3 or 4	□	Illum, momentary	A0107Y		
□	blue	A0162F	LED	12V amber	A0142M3	3 or 4	□	Illum, maintained	A0107X		
□	clear	A0162G	LED	12V blue	A0142M4	3 or 4	□	Non-illum, momentary	A0108Y		
□	white	A0162J	LED	12V white	A0142M5	3 or 4	□	Non-illum, maintained	A0108X		
○	black	A0163A	LED	24V red	A0142N1	1 or 2	○	Illum, momentary	A0109Y		
○	red	A0163B	LED	24V green	A0142N2	1 or 2	○	Illum, maintained	A0109X		
○	amber	A0163C	LED	24V amber	A0142N3	1 or 2	○	Non-illum, momentary	A0110Y		
○	yellow	A0163D	LED	24V blue	A0142N4	1 or 2	○	Non-illum, maintained	A0110X		
○	green	A0163E	LED	24V white	A0142N5	3 or 4	○	Illum, momentary	A0111Y		
○	blue	A0163F	LED	48V red	A0142P1	3 or 4	○	Illum, maintained	A0111X		
○	clear	A0163G	LED	48V green	A0142P2	3 or 4	○	Non-illum, momentary	A0112Y		
○	white	A0163J	LED	48V amber	A0142P3	3 or 4	○	Non-illum, maintained	A0112X		

Unsealed switches (IP40):
 add '01' to end of operator model number

Screen engraving/insertable legends:
 contact APEM Components

Bi-colour LEDs optional

Bezel: □ rectangular □ square ○ round. 'Illum' - illuminated, 'Non-illum' - non illuminated

A01 SERIES INDICATORS

Panel cut-out Ø16 (.630)

An indicator assembly requires:

screen + lamp + operator

To order these elements, select desired model numbers from tables below.

Example: IP65 rectangular indicator with red screen and 12V red LED = A0161B, A0142M1 and A0171

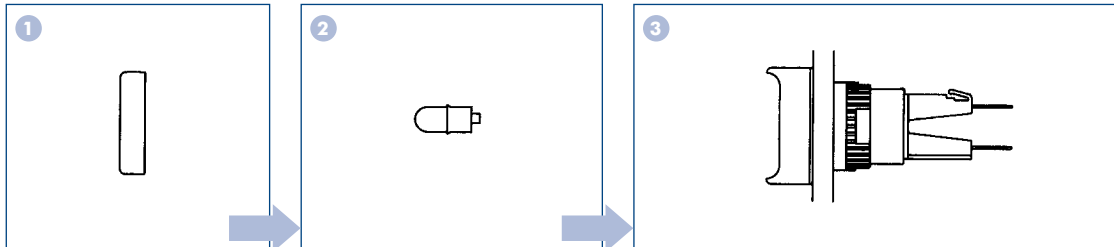
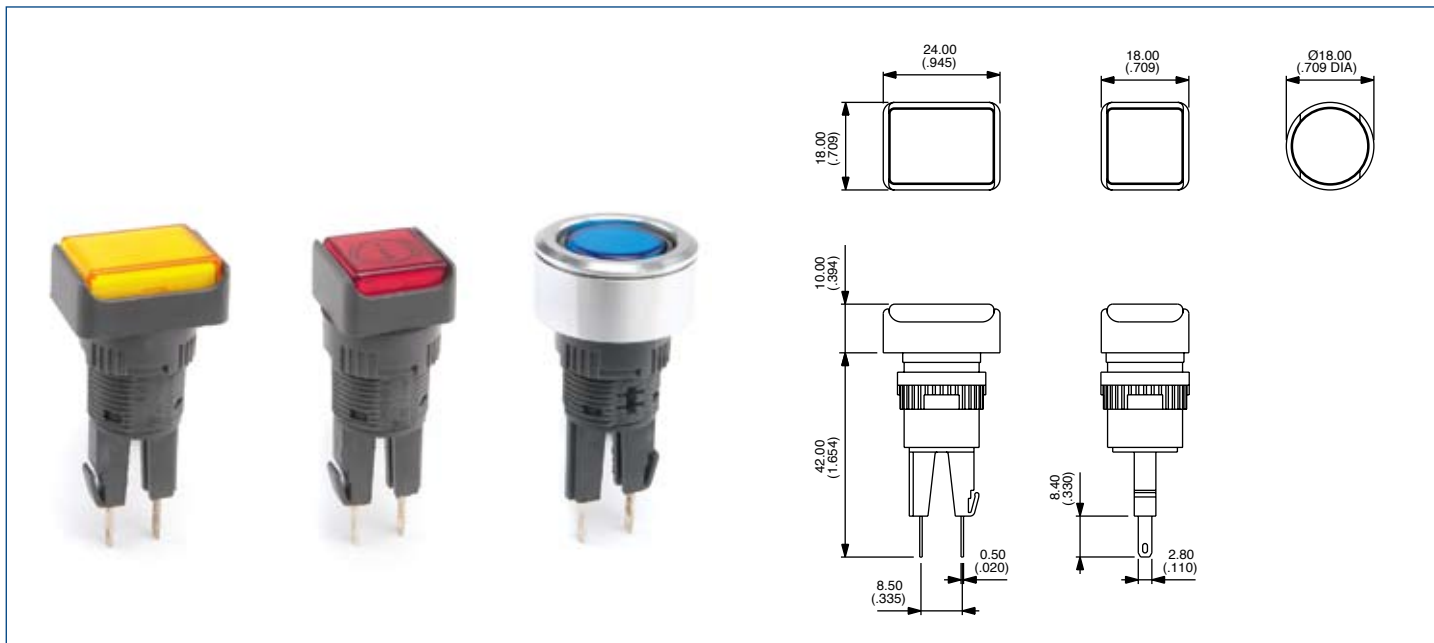

Screen

Bezel	Colour	Part No
□	black	A0161A
□	red	A0161B
□	amber	A0161C
□	yellow	A0161D
□	green	A0161E
□	blue	A0161F
□	clear	A0161G
□	white	A0161J
□	black	A0162A
□	red	A0162B
□	amber	A0162C
□	yellow	A0162D
□	green	A0162E
□	blue	A0162F
□	clear	A0162G
□	white	A0162J
○	black	A0163A
○	red	A0163B
○	amber	A0163C
○	yellow	A0163D
○	green	A0163E
○	blue	A0163F
○	clear	A0163G
○	white	A0163J

Lamp

Lamp	Voltage	Part No
Filament	6.3V	A0141A
Filament	14V	A0141B
Filament	28V	A0141C
Filament	36V	A0141D
Filament	48V	A0141E
Filament	60V	A0141F
Neon	110V	A0143G
Neon	220V	A0143H
LED	6V red	A0142L1
LED	6V green	A0142L2
LED	6V amber	A0142L3
LED	12V red	A0142M1
LED	12V green	A0142M2
LED	12V amber	A0142M3
LED	12V blue	A0142M4
LED	12V white	A0142M5
LED	24V red	A0142N1
LED	24V green	A0142N2
LED	24V amber	A0142N3
LED	24V blue	A0142N4
LED	24V white	A0142N5
LED	48V red	A0142P1
LED	48V green	A0142P2
LED	48V amber	A0142P3

Operator

Bezel	Description	Part No
□	Indicator	A0171
□	Indicator	A0172
○	Indicator	A0173

Unsealed switches (IP40):
add '01' to end of operator model number

Screen engraving/insertable legends:
contact APEM Components

Bezel: □ rectangular □ square ○ round.

A01 SERIES

ROTARY LEVER SWITCHES

Panel cut-out Ø16 (.630)

A rotary level switch assembly requires:

operator + switchblock

To order these elements, select desired model numbers from tables below.

Example: IP65 rectangular rotary switch with long lever, single pole, 2 positions maintained = A019101 and A0151B

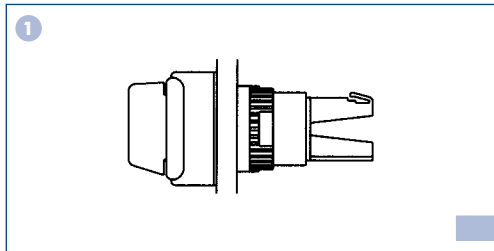
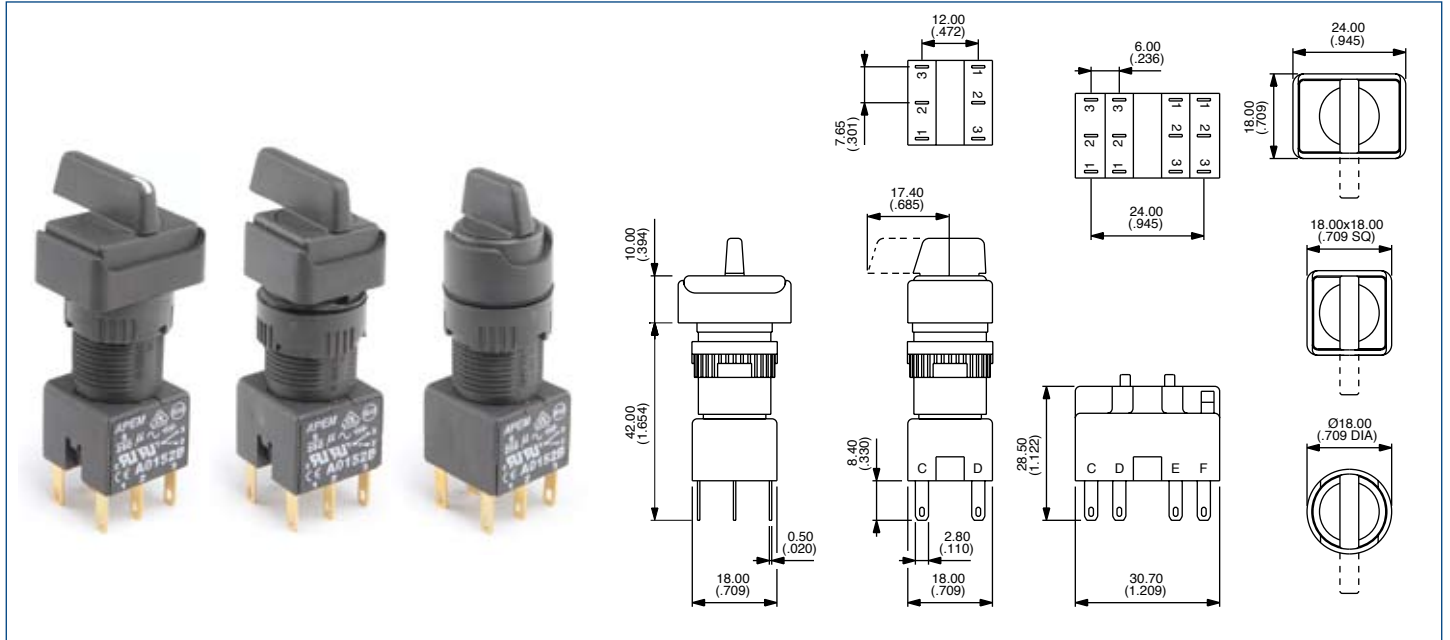
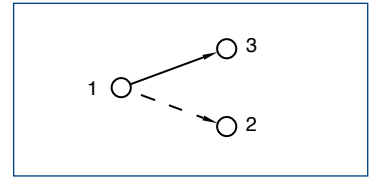

Operator

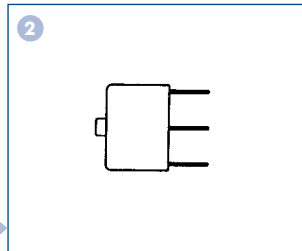

Switch block

Pole	Bezel	Description	Short lever	Long lever
1 or 2	□	2 pos. maintained	A019201	A019101
1 or 2	□	2 pos. momentary	A019202	A019102
3 or 4	□	2 pos. maintained	A019203	A019103
3 or 4	□	2 pos. momentary	A019204	A019104
1 or 2	□	3 pos. maintained	A019205	A019105
1 or 2	□	3 pos. momentary	A019206	A019106
1 or 2	□	3 pos. mainL, momR	A019207	A019107
1 or 2	□	3 pos. momL, mainR	A019208	A019108
1 or 2	□	2 pos. maintained	A019401	A019301
1 or 2	□	2 pos. momentary	A019402	A019302
3 or 4	□	2 pos. maintained	A019403	A019303
3 or 4	□	2 pos. momentary	A019404	A019304
1 or 2	□	3 pos. maintained	A019405	A019305
1 or 2	□	3 pos. momentary	A019406	A019306
1 or 2	□	3 pos. mainL, momR	A019407	A019307
1 or 2	□	3 pos. momL, mainR	A019408	A019308
1 or 2	○	2 pos. maintained	A019601	A019501
1 or 2	○	2 pos. momentary	A019602	A019502
3 or 4	○	2 pos. maintained	A019603	A019503
3 or 4	○	2 pos. momentary	A019604	A019504
1 or 2	○	3 pos. maintained	A019605	A019505
1 or 2	○	3 pos. momentary	A019606	A019506
1 or 2	○	3 pos. mainL, momR	A019607	A019507
1 or 2	○	3 pos. momL, mainR	A019608	A019508

No of poles	Part No
Single pole	A0151B
Double pole	A0152B
Three pole	A0155B
Four pole	A0153B

• Note: 3/4 pole switch block for use only with 2 position rotary lever

Lever Positions

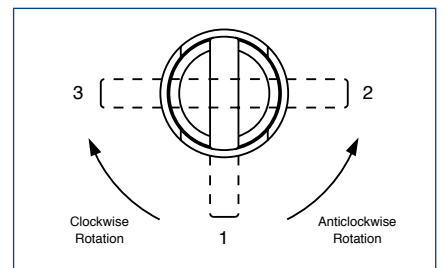

Lever Rotation – 2 position switches

The model numbers shown are for switches with anticlockwise lever rotation.

For clockwise rotation, replace:

- 01 with 09
- 02 with 10
- 03 with 11
- 04 with 12

at the end of the model number

Optional engraving on lever end add "WL" to the end of the part number.

Bezel: □ rectangular □ square ○ round. 'pos' - position, 'mainL' - maintained left 'momR' - momentary right, etc

A01 SERIES

KEYLOCK SWITCHES

Panel cut-out Ø16 (.630)

An keylock assembly requires:

operator + switchblock

To order these elements, select desired model numbers from tables below.

Example: IP65 rectangular keyswitch, single pole, 2 positions maintained = A018101 and A0151B

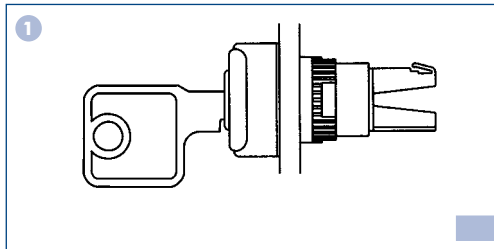
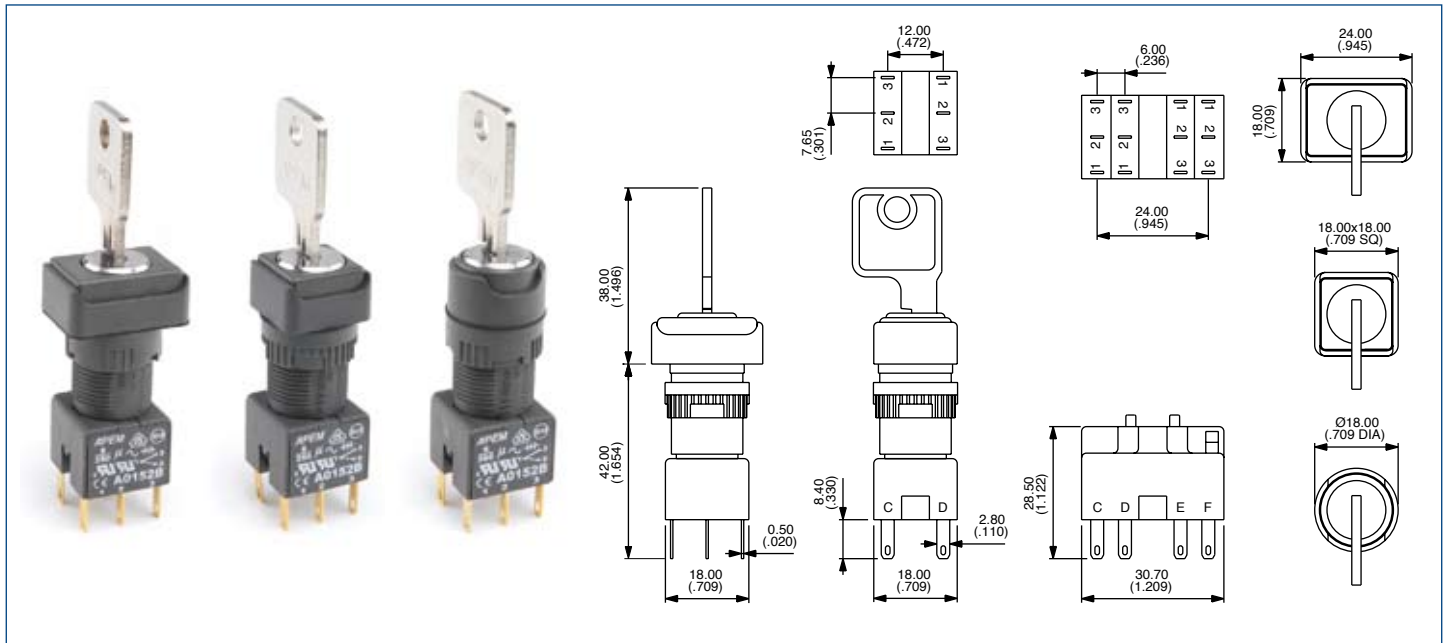
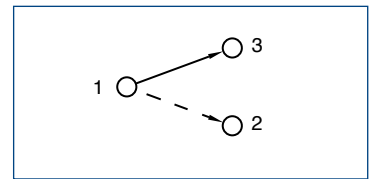

Operator

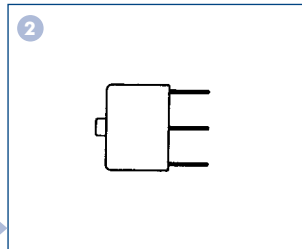

Switch block

Pole	Bezel	Description	Part No.	Key removable
1 or 2	□	2 pos. maintained	A018101	A-C
1 or 2	□	2 pos. momentary	A018102	A
3 or 4	□	2 pos. maintained	A018103	A-C
3 or 4	□	2 pos. momentary	A018104	A
1 or 2	□	3 pos. maintained	A018105	A-B-C
1 or 2	□	3 pos. momentary	A018106	A
1 or 2	□	3 pos. mainL, momR	A018107	A-B
1 or 2	□	3 pos. momL, mainR	A018108	A-C
1 or 2	□	2 pos. maintained	A018201	A-C
1 or 2	□	2 pos. momentary	A018202	A
3 or 4	□	2 pos. maintained	A018203	A-C
3 or 4	□	2 pos. momentary	A018204	A
1 or 2	□	3 pos. maintained	A018205	A-B-C
1 or 2	□	3 pos. momentary	A018206	A
1 or 2	□	3 pos. mainL, momR	A018207	A-B
1 or 2	□	3 pos. momL, mainR	A018208	A-C
1 or 2	○	2 pos. maintained	A018301	A-C
1 or 2	○	2 pos. momentary	A018302	A
3 or 4	○	2 pos. maintained	A018303	A-C
3 or 4	○	2 pos. momentary	A018304	A
1 or 2	○	3 pos. maintained	A018305	A-B-C
1 or 2	○	3 pos. momentary	A018306	A
1 or 2	○	3 pos. mainL, momR	A018307	A-B
1 or 2	○	3 pos. momL, mainR	A018308	A-C

No of poles	Part No
Single pole	A0151B
Double pole	A0152B
Three pole	A0155B
Four pole	A0153B

- Non-removable key positions: contact APEM components
- 2 standard keys are supplied
- 20 key barrel types available from stock
- For on-on-on function contact APEM components
- Note: 3/4 pole switch block for use only with 2 position key switches

Key Positions

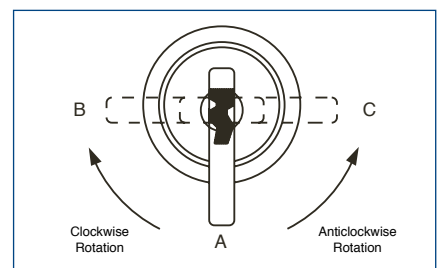

Key Rotation – 2 position switches

The model numbers shown are for switches with anticlockwise key rotation.

For clockwise rotation, replace:

- 01 with 25
- 02 with 24
- 03 with 27
- 04 with 28

at the end of the model number

Bezel: □ rectangular □ square ○ round. 'pos' - position, 'mainL' - maintained left 'momR' - momentary right, etc

A01 SERIES

EMERGENCY STOP SWITCHES

Panel cut-out Ø16 (.630)

- Prominent Ø 24mm (.944) or optional Ø 40mm (1.575) dia. red mushroom actuator
- Highly reliable positive break switch
- Push to shut off switch, twist to reset to ON

An emergency stop switch assembly requires:

operator + switch block

To order specify with single pole or double pole positive break switch block.

Approved to UL1054/EN 60947-5-1

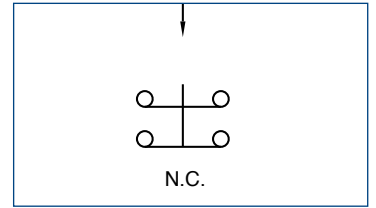

General Specifications

Min. Mechanical Life	: 6050 cycles (6 cycles per minute)
Operating Force	: 16N – 0.1Nm
Operating Temperature	: -20°C to +55°C
Solder Heat Resistance	: 350°C, 5 secs (IEC 68-2-2-20Tb, method 2)
Degree of Environmental Protection (IEC 529)	: IP65 front of panel IP40 back of panel
Switch Terminals	: Solder/quick-connect 2.8mm (.110) (IEC 68-2-20)

Electrical Specifications

Current/Voltage rating	: 1.5A 250 VAC AC-15
Contact Gap	: >3mm
Dielectric test voltage	: 2900V
Electrical Life	: >6050

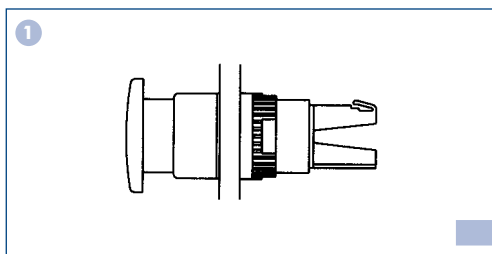
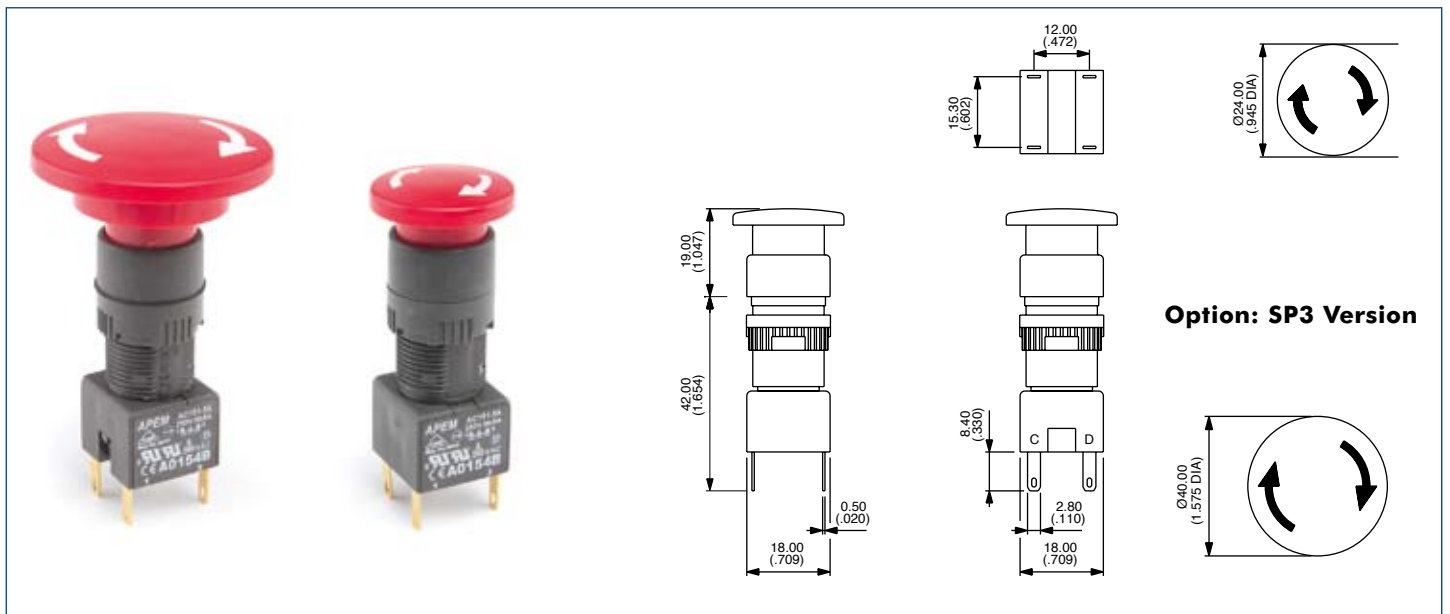

Operator

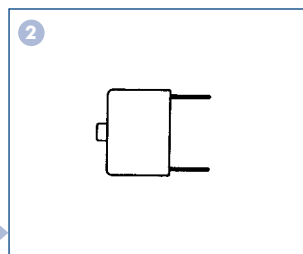

Switch block

Bezel	Description	Part No
○	Emergency stop	A01ES
Option		
40Ømm	Emergency stop	A01ES SP3

No of poles	Part No
Single pole	A0150B
Double pole	A0154B

Accessories



60Ø Self Adhesive Label

Description	Part No
Yellow label with text	A01YL1
Yellow label	A01YL2

A01 SERIES

EMERGENCY STOP SWITCHES/MUSHROOM HEAD PUSHBUTTON SWITCHES

Fitted in Enclosures

- Prominent Ø 40mm (1.575) dia. red mushroom actuator, twist to release
- Robust polycarbonate enclosures
- Highly reliable positive break switching on E-stop
- Sealed to IP65
- 6A current rating
- Knockouts for popular conduit sizes
- Double pole changeover switch blocks available for momentary/maintained mushroom head pushbuttons

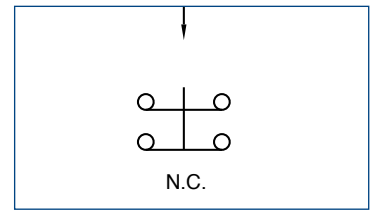

Emergency Stop

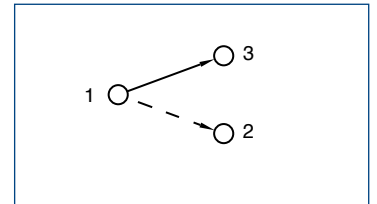

Momentary and Maintained

Technical Specifications

Contact Rating	: 6A 250 VAC/1.5A 250 VAC – E-Stop
Dimensions	: 65 x 65 x 57mm
Electrical Life	: 50,000 cycles/6050 cycles – E-Stop
Operating Temperature	: -20°C – +55°C

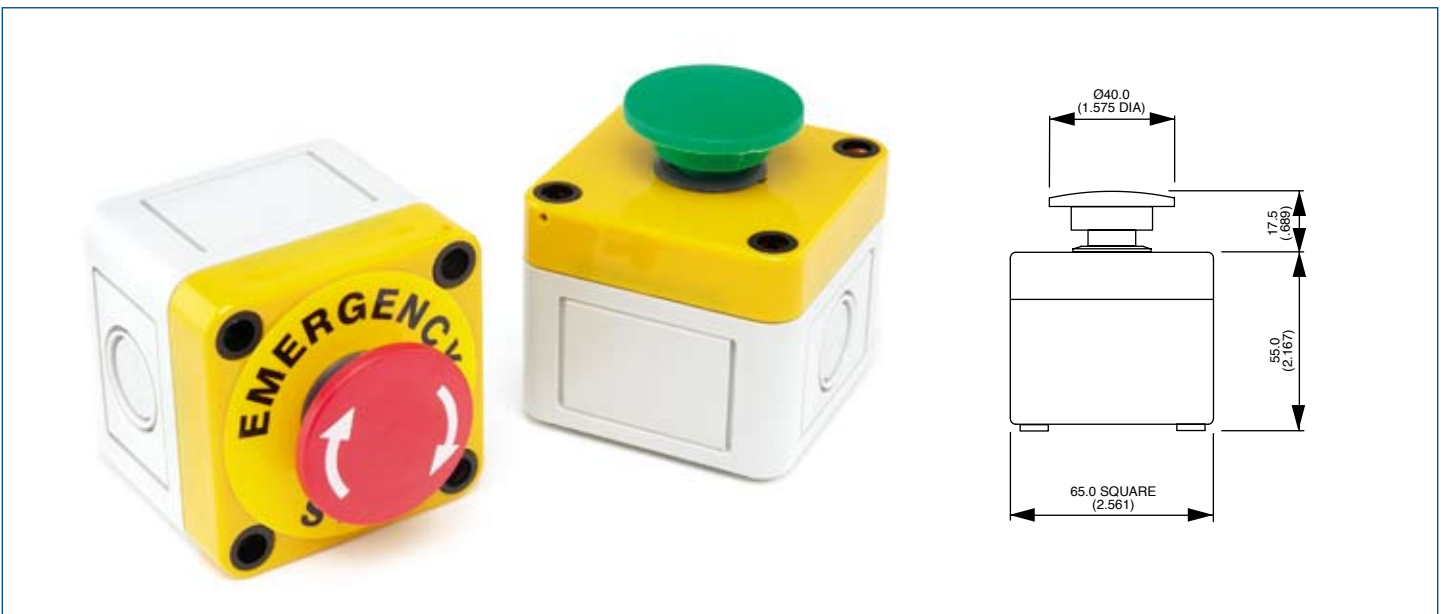

Description	Part No
Emergency Stop	A01ESSP354B + PEA01
Black Momentary	A01MMASP352B + PEA01
Red Momentary	A01MMBSP352B + PEA01
Yellow Momentary	A01MMDSP352B + PEA01
Green Momentary	A01MMESP352B + PEA01
Blue Momentary	A01MMFSP352B + PEA01
Black Maintained	A01MXASP352B + PEA01
Red Maintained	A01MXBSP352B + PEA01
Yellow Maintained	A01MXDSP352B + PEA01
Green Maintained	A01MXESP352B + PEA01
Blue Maintained	A01MXFSP352B + PEA01

Options
 12A 250V versions or custom printing on mushroom head actuators please contact APEM Components.

A01 SERIES

MUSHROOM HEAD PUSHBUTTON SWITCHES

Panel cut-out Ø16 (.630)

- Prominent Ø 24mm (.944) or optional Ø 40mm (1.575) dia. mushroom actuators
- Momentary and maintained functions. Momentary function versions are unmarked, maintained function versions are twist release (arrows indicate direction of twist)
- Various coloured mushroom actuators are available

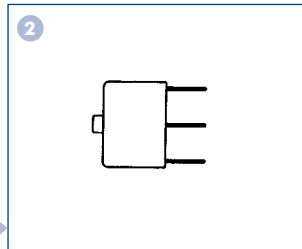
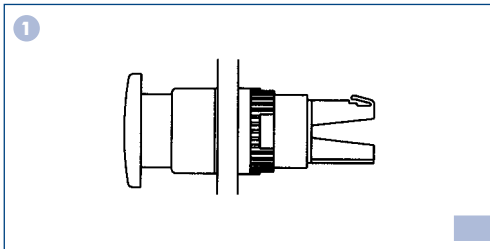
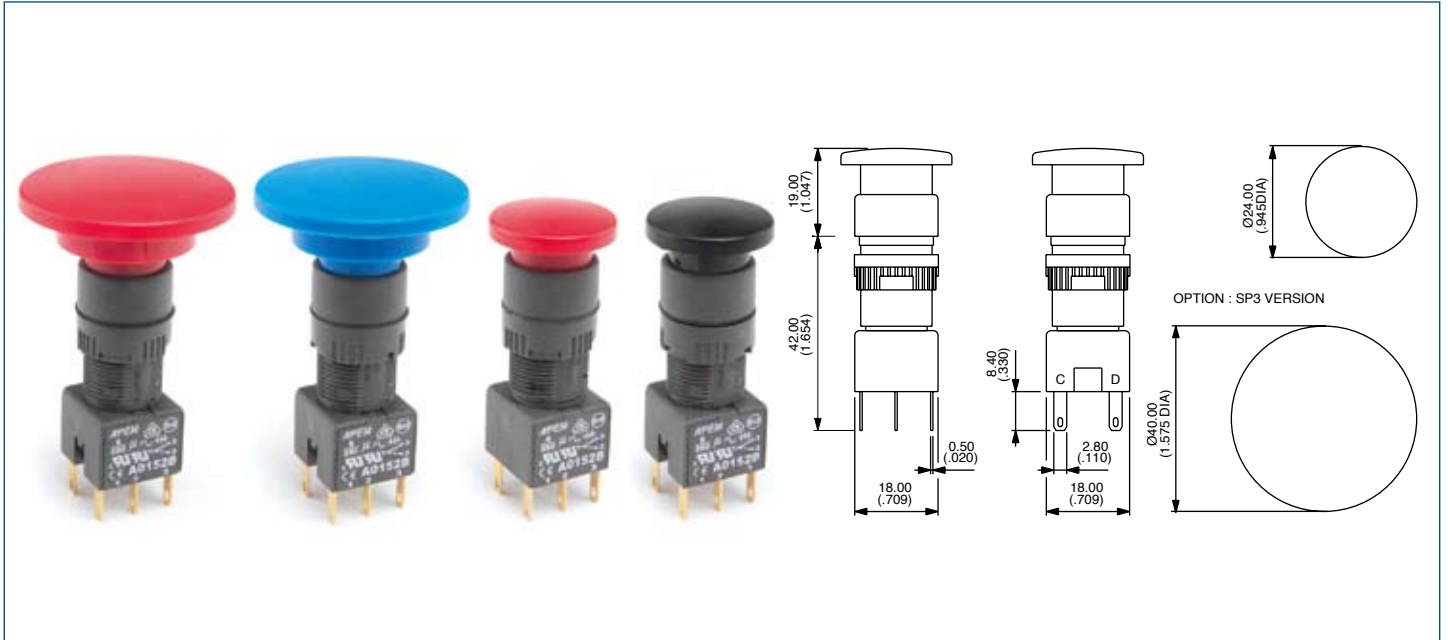
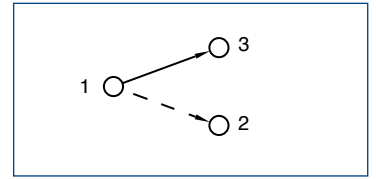

Operator

Switch block

Actuator	Description	Part No
24mmØ	Black Momentary	A01MMA
24mmØ	Red Momentary	A01MMB
24mmØ	Yellow Momentary	A01MMD
24mmØ	Green Momentary	A01MME
24mmØ	Blue Momentary	A01MMF
24mmØ	Black Maintained	A01MXA
24mmØ	Red Maintained	A01MXB
24mmØ	Yellow Maintained	A01MXD
24mmØ	Green Maintained	A01MXE
24mmØ	Blue Maintained	A01MXF
40mmØ	Black Momentary	A01MMA SP3
40mmØ	Red Momentary	A01MMB SP3
40mmØ	Yellow Momentary	A01MMD SP3
40mmØ	Green Momentary	A01MME SP3
40mmØ	Blue Momentary	A01MMF SP3
40mmØ	Black Maintained	A01MXA SP3
40mmØ	Red Maintained	A01MXB SP3
40mmØ	Yellow Maintained	A01MXD SP3
40mmØ	Green Maintained	A01MXE SP3
40mmØ	Blue Maintained	A01MXF SP3

No of poles	Part No
Single pole	A0151B
Double pole	A0152B
Three pole	A0155B
Four pole	A0153B