

SQUARE NUT M04 H WITH POSITION FIXING

Article Nr. 21.1310/4

[See the product on the website](#) →

[Download CAD Files](#) →

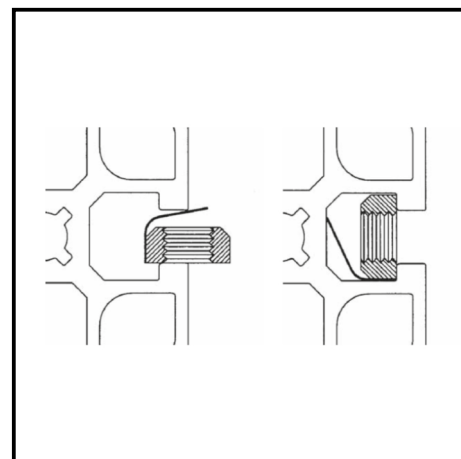
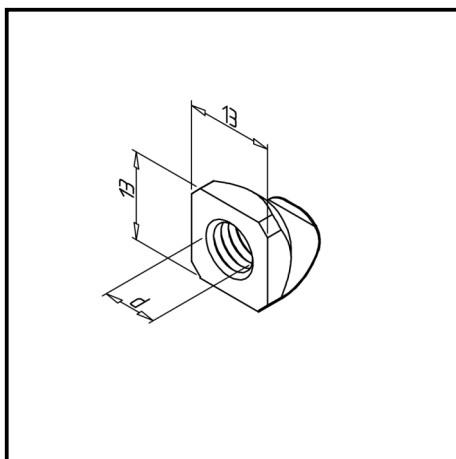
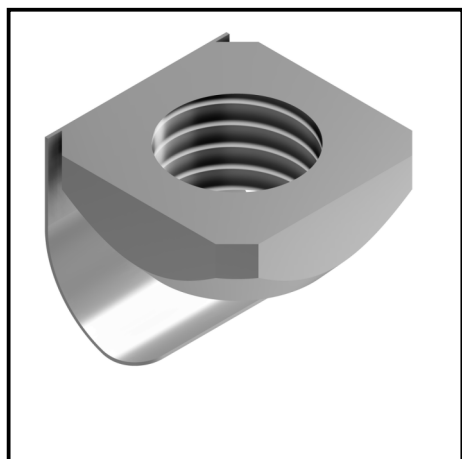

TECHN. DATA / ITEMS SUPPLIED

- Stainless steel
- Thread (d) : M 4
- Weight = 0.006 kg/piece

APPLICATIONS

- Sliding nuts can be swiveled into the profile (series 45) at any point
- The spring plate holds the nut in the desired position

ASSEMBLY

- Mounting by swiveling into the groove