

THIS DOCUMENT IS SUBJECT TO CHANGE WITHOUT NOTICE. IT IS CONFIDENTIAL AND A PROPERTY OF Amphenol LTW. DISCLOSURE TO THIRD PARTY HAS TO BE AUTHORIZED BY Amphenol LTW.

REV.	ECN NO.	DATE	SIGN	DESCRIPTION
F	C201472	2020/09/29	Vicky	△F X6
G	C210023	2021/01/14	Vicky	△G X2
H	C210239	2021/04/06	Ruru	△H X4

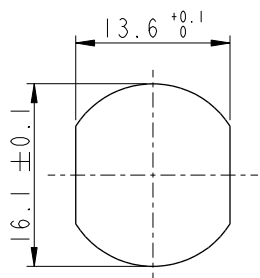
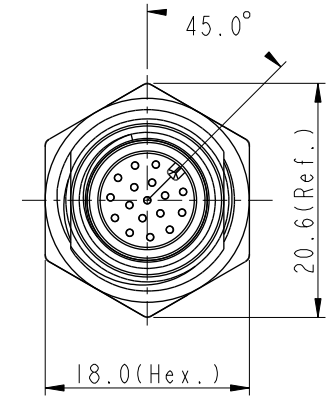
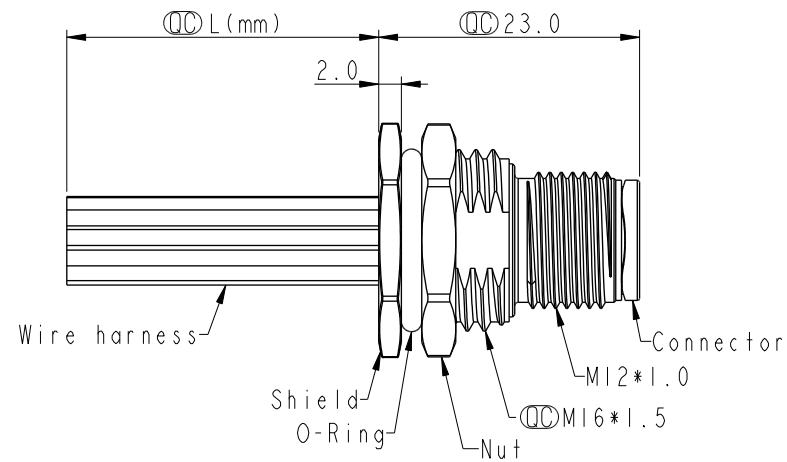
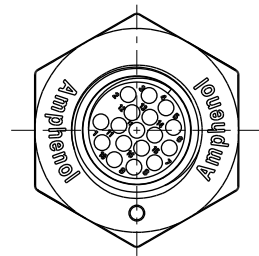

Recommended Panel Cut-Out

- Note: △C △D △F △G △H
- * RoHS Compliant
 - * Ⓞ Important dimension
 - * Waterproof rate: IPX8, unmated 1m/24h
IPX9K, unmated
 - * Connector
Housing: Thermoplastic, Black
Pin: Copper alloy, Gold plated
 - * Shield: Metal
 - * Nut: Metal
 - * O-Ring: Rubber, Black
 - * Wire harness: UL1061
 - * For panel thickness max: 4.5mm
 - * O-Ring and nut are assembled on connectors
 - * Wire harness tolerance: 100mm: ±10mm
100mm < L ≤ 300mm: ±15mm
300mm < L ≤ 1000mm: ±20mm
1000mm < L ≤ 1500mm: ±50mm

UNIT: mm		
TOLERANCE	.X ±0.25	
.XX ±0.1		
.XXX ±0.05		
ANGLES	±1°	

TITLE N SEN, M12 A, SCREW RECEPTACLE, M, M, FI/PANEL CRIMP				
SCALE 1:1	SIZE A4	SHEET 1 OF 2		
REV. H	WC-REV. A.5	Ⓞ: Inspection item		

Amphenol LTW
安費諾亮泰企業股份有限公司

ITEM NO	DRAWN BY Ruru	DATE 2019-09-19
DWG NO △E M12A-XXPMMC-SF8CXX	CHECKED BY Rita	DATE 2019-09-19
CUSTOMER ALTW	APPROVED BY Max	DATE 2019-09-19

THIS DOCUMENT IS SUBJECT TO CHANGE WITHOUT NOTICE. IT IS CONFIDENTIAL AND A PROPERTY OF Amphenol LTW. DISCLOSURE TO THIRD PARTY HAS TO BE AUTHORIZED BY Amphenol LTW.

E	17P	26	M12A-17PMMC-SF8CXX
	5P	22	M12A-05PMMC-SF8CXX
	4P		M12A-04PMMC-SF8CXX
	3P		M12A-03PMMC-SF8CXX
Contacts	AWG	Item No.	

 M12A-XXPMMC-SF8CXX

XX: No. Of Pin

10: 100mm
 15: 150mm
 20: 200mm
 }
 95: 950mm
 Cable Pitch Unit=50mm

 A0: 1000mm
 }
 A5: 1500mm
 Cable Pitch Unit=100mm
 Wire Length (L): 150~1500 mm

E

17	White/Gray	白/灰
16	Yellow/Brown	黃/棕
15	White/Yellow	白/黃
14	Brown/Green	棕/綠
13	White/Green	白/綠
12	Red/Blue	紅/藍
11	Gray/Pink	灰/粉
10	Violet	紫
9	Red	紅
8	Gray	灰
7	Black	黑
6	Yellow	黃
5	Pink	粉
4	Green	綠
3	White	白
2	Blue	藍
1	Brown	棕



5	--	黑	5	--	灰
4	Black	黑	4	Black	黑
3	Blue	藍	3	Blue	藍
2	--	白	2	White	白
1	Brown	棕	1	Brown	棕

Pin # Wire Pin # Wire Pin # Wire Pin # Wire

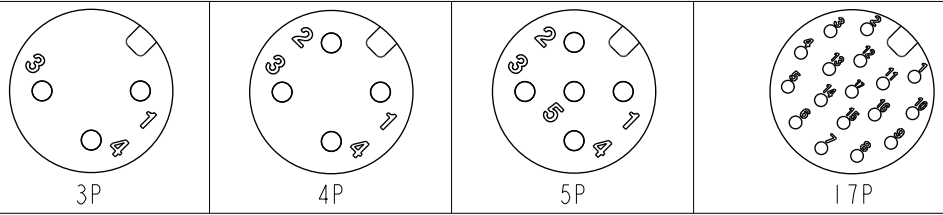
Pin Out



Pin Assignments Front View

UNIT: mm			TITLE N SEN, M12 A, SCREW RECEPTACLE, M, M, FI/PANEL CRIMP	
TOLERANCE .X ±0.25 .XX ±0.1 .XXX ±0.05 ANGLES ±1°	SCALE 1:1		SIZE A4	SHEET 2 OF 2
REV. H		WC-REV. A.5	QC: Inspection item	

Amphenol LTW
 安費諾亮泰企業股份有限公司

ITEM NO	DRAWN BY Ruru	DATE 2019-09-19
DWG NO M12A-XXPMMC-SF8CXX	CHECKED BY Rita	DATE 2019-09-19
CUSTOMER ALTW	APPROVED BY Max	DATE 2019-09-19