

Deep groove ball bearings 6202-C (Series 62..-C)

modified internal construction (Generation C), main dimensions to DIN 625-1

The datasheet is only an overview of dimensions and basic load ratings of the selected product. Please always observe all the guidelines in these overview pages. Further information is given on many products under the menu item "Description". You can also order comprehensive information via the Catalogue selection system (https://www.schaeffler.de/content.schaeffler.de/en/news_media/index.jsp) or by telephone on +49 (91 32) 82 - 28 97.

d	15 mm
D	35 mm
B	11 mm
D ₂	30,9 mm
d ₂	20,1 mm
D _{a max}	30,8 mm
d _{a min}	19,2 mm
r _{a max}	0,6 mm
r _{min}	0,6 mm
m	0,043 kg Mass

C_r	8400 N	Basic dynamic load rating, radial
C_{0r}	3750 N	Basic static load rating, radial
C_{ur}	260 N	Fatigue limit load, radial
n_G	33000 1/min	Limiting speed
$n_{\theta r}$	21900 1/min	Reference speed
f_0	13	Calculation factor

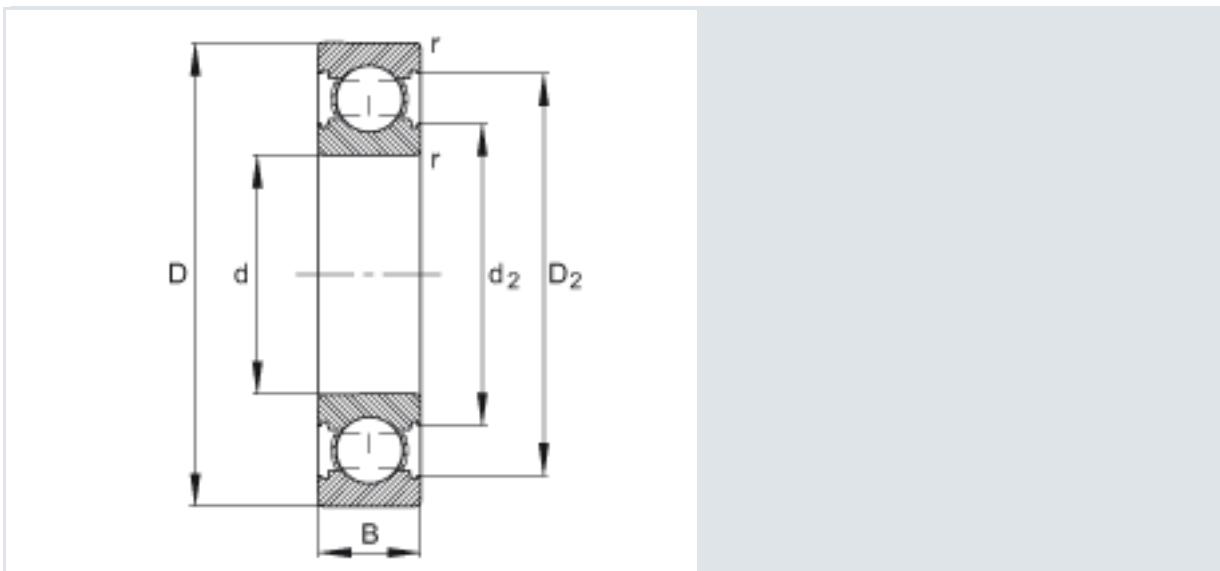

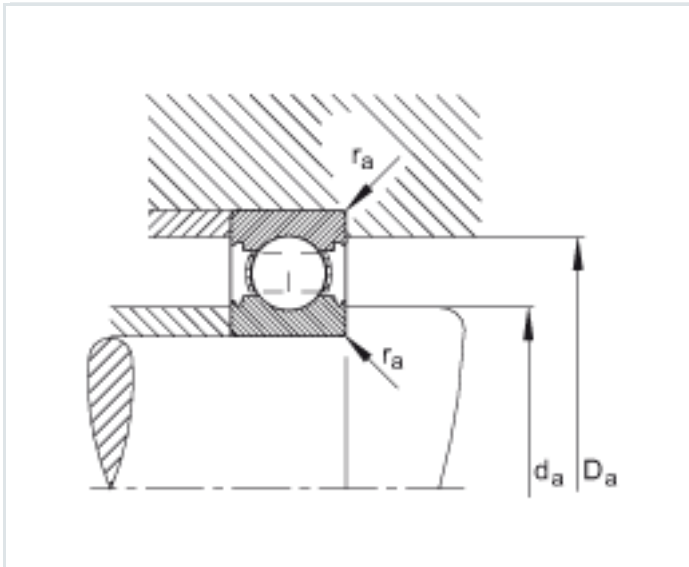

Mounting dimensions