

Alle Rechte vorbehalten/ All rights reserved

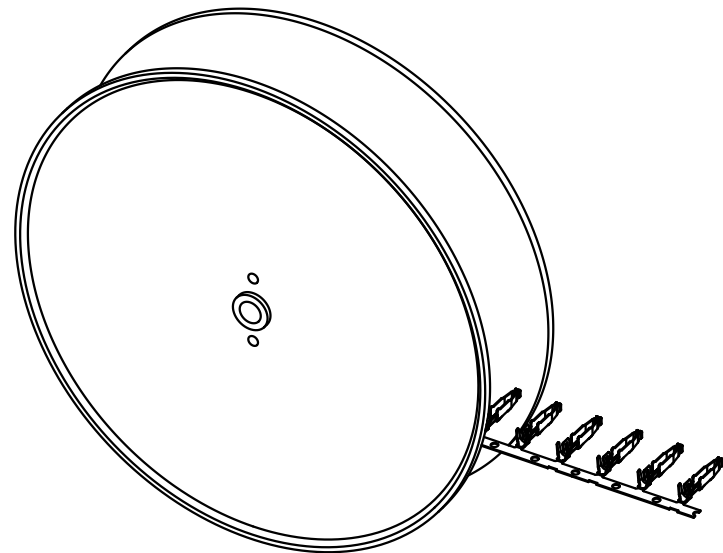
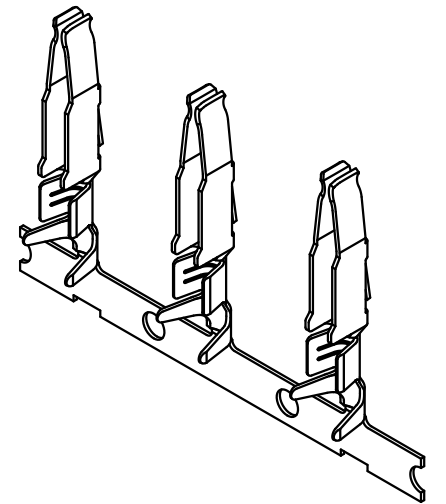
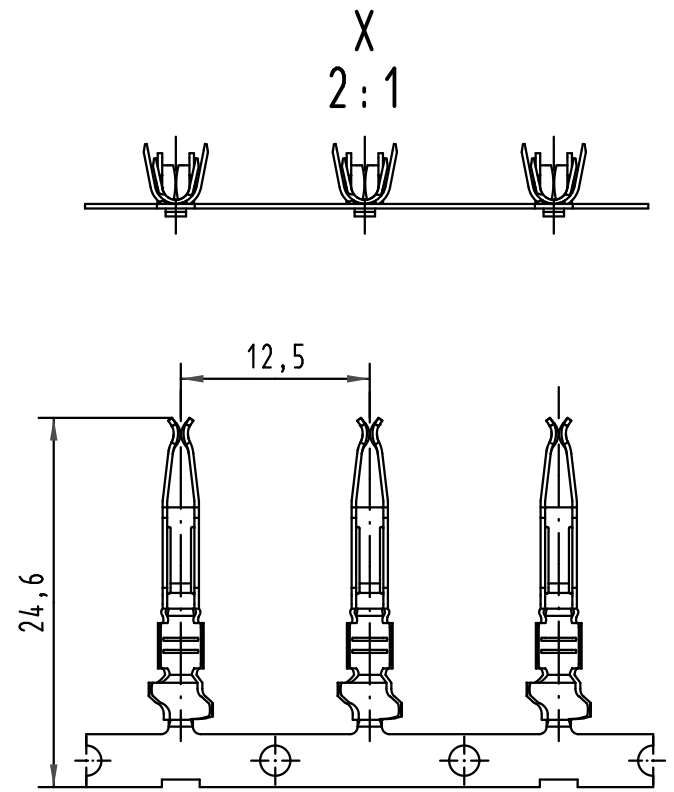
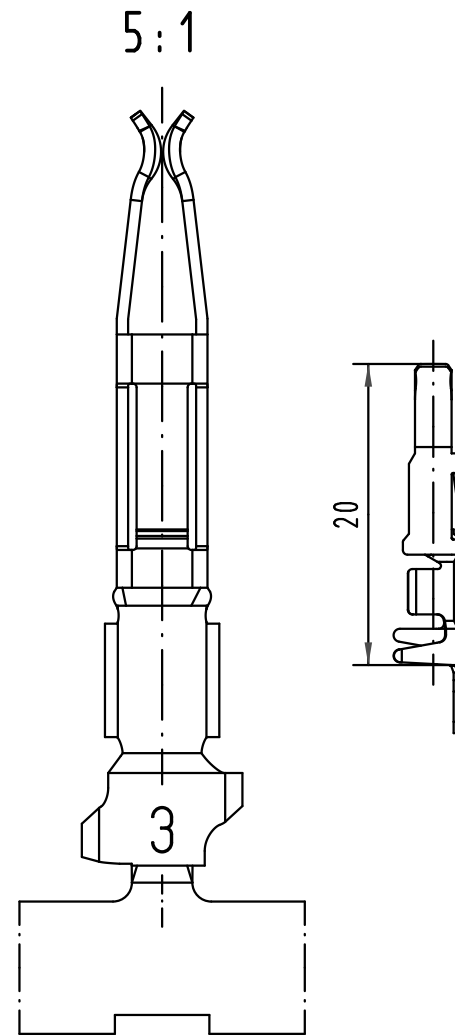
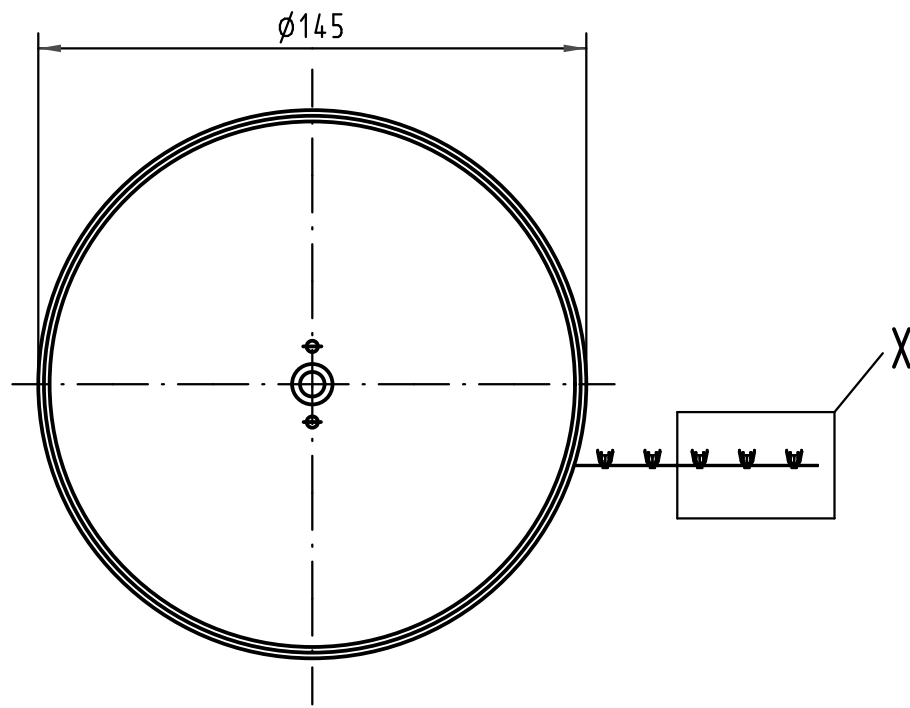
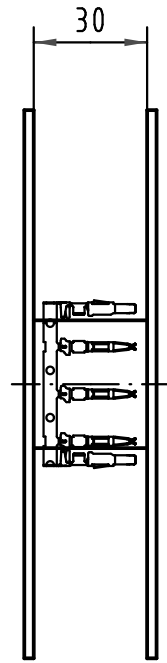

09 06 000 7482	2
09 06 000 7472	1
Bestell-Nr. part-no.	Anforderungsstufe nach IEC performance level acc.to IEC

All Dimensions in mm Original Size DIN A 3	Techn. Character.			Nicht tolerierte Maßel Free size tolerances complementary IEC 60603-2	
		Dat.	Name	Maßstab/Scale	Bauform/type F-C crimp Federkontakt Crimpkontur 3 für 0,5 - 1,5mm ² 250 Kontakte auf Haspel female contact crimp contour 3 for 0,5 - 1,5mm ² 250 contacts on reel
	Detail.	17.01.06	Leh.	1:2	
	Insp.	17.01.06	Ge.		
	Stand.				
35449	17.11.08	Hage.	HARTING Electronics GmbH & Co. KG		TB 09 06 000 74x2
33227			D-32339 ESPELKAMP		
Mod.	Dat.	Name			Blatt/ page
			Sub.		