

# GW CSBRM3.HW

## OSLON® Square

OSLON® Square Horti White now comes with a unique innovative radiation pattern. Paired with a customized phosphor solution, this latest LED illuminates plants evenly for uniform growth while facilitating the increase of non-converted red photons to deliver superior fixture level efficacy. Additionally, this high-power LED provides excellent reliability, long lifetime, proven robustness and low thermal resistance in a compact footprint

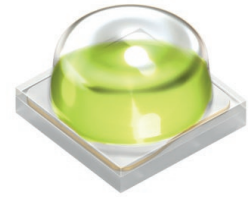

## Applications

- Horticulture Lighting

## Features:

- Package: SMD ceramic package with silicone lens
- Typ. Radiation: 150°
- Corrosion Robustness Class: 3B
- ESD: 8 kV acc. to ANSI/ESDA/JEDEC JS-001 (HBM, Class 3B)
- Radiant Flux: typ. 1125 mW @ 700mA ; typ. 599 mW @ 350mA
- Radiant Efficiency: typ. 55% @ 700mA; typ. 61% @ 350mA
- Photosynthetic Photon Flux: typ. 4.95  $\mu\text{mol/s}$  @ 700mA ; typ. 2.63  $\mu\text{mol/s}$  @ 350mA
- Photon Flux Efficacy: typ 2.44  $\mu\text{mol/J}$  @ 700mA ; typ 2.68  $\mu\text{mol/J}$  @ 350mA

---

## Ordering Information

Type	Total radiant flux <sup>1)</sup> $I_F = 700 \text{ mA}$ $\Phi_E$	Ordering Code
GW CSBRM3.HW-VNAQ-H1H2-1	960 ... 1300 mW	Q65113A3729
GW CSBRM3.HW-VNAQ-H3H4-1	960 ... 1300 mW	Q65113A3728

## Maximum Ratings

Parameter	Symbol		Values
Operating Temperature	$T_{op}$	min.	-40 °C
		max.	125 °C
Storage Temperature	$T_{stg}$	min.	-40 °C
		max.	125 °C
Junction Temperature	$T_j$	max.	135 °C
Forward current	$I_F$	min.	100 mA
		max.	1800 mA
Surge Current $t \leq 10 \mu s$ ; $D = 0.005$ ; $T_j = 25 \text{ °C}$	$I_{FS}$	max.	2000 mA
Reverse voltage <sup>2)</sup>	$V_R$		Not designed for reverse operation
ESD withstand voltage acc. to ANSI/ESDA/JEDEC JS-001 (HBM, Class 3B)	$V_{ESD}$		8 kV

## Characteristics

$I_F = 700 \text{ mA}$ ;  $T_J = 25 \text{ °C}$

Parameter	Symbol		Values
Viewing angle at 50% $I_V$	$2\phi$	typ.	140 °
Forward Voltage <sup>3)</sup> $I_F = 700 \text{ mA}$	$V_F$	min. typ. max.	2.80 V 2.90 V 3.20 V
Reverse current <sup>2)</sup>	$I_R$		Not designed for reverse operation
Electrical thermal resistance junction/solderpoint with efficiency $\eta_e = 55 \%$	$R_{thJS \text{ elec.}}$	typ.	1.6 K / W

## Brightness Groups

Group	Total radiant flux <sup>1)</sup> $I_F = 700 \text{ mA}$ min. $\Phi_E$	Total radiant flux <sup>1)</sup> $I_F = 700 \text{ mA}$ max. $\Phi_E$	PF min. $\Phi_p$	PF max. $\Phi_p$	PF/W typ.	Luminous flux min. $\Phi_V$	Luminous flux max. $\Phi_V$
VN	960 mW	1035 mW	4.23 $\mu\text{mol/s}$	4.56 $\mu\text{mol/s}$	2.17 $\mu\text{mol/J}$	335 lm	361 lm
VO	1035 mW	1120 mW	4.56 $\mu\text{mol/s}$	4.93 $\mu\text{mol/s}$	2.34 $\mu\text{mol/J}$	361 lm	390 lm
AP	1120 mW	1210 mW	4.93 $\mu\text{mol/s}$	5.33 $\mu\text{mol/s}$	2.53 $\mu\text{mol/J}$	390 lm	422 lm
AQ	1210 mW	1300 mW	5.33 $\mu\text{mol/s}$	5.72 $\mu\text{mol/s}$	2.72 $\mu\text{mol/J}$	422 lm	453 lm

Note: [\*] Photosynthetic Photon Flux includes wavelengths between 400 and 700 nm

Note: [\*\*] Photon Flux includes wavelengths between 280 and 800 nm

Note: PPF and PF values are for reference only

## Forward Voltage Groups

Group	Forward Voltage <sup>3)</sup> $I_F = 700 \text{ mA}$ min. $V_F$	Forward Voltage <sup>3)</sup> $I_F = 700 \text{ mA}$ max. $V_F$
L1	2.80 V	2.90 V
L2	2.90 V	3.00 V
M1	3.00 V	3.10 V
M2	3.10 V	3.20 V

### Chromaticity Coordinate Groups <sup>4)</sup>

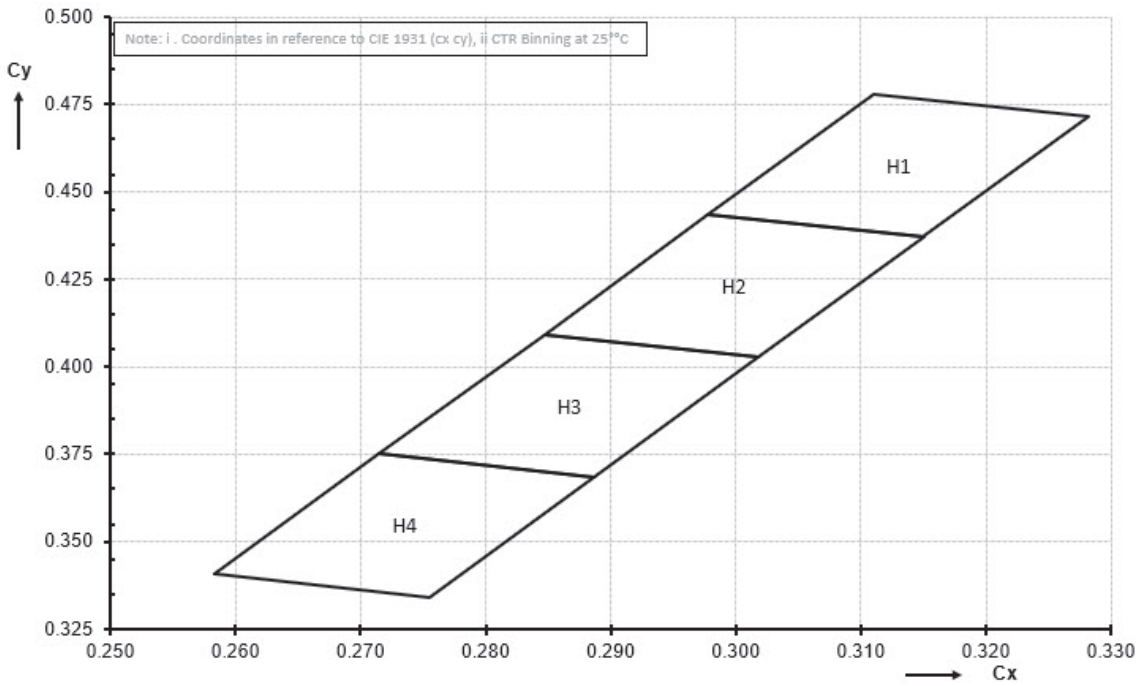

### Chromaticity Coordinate Groups

Group	Cx	Cy	Group	Cx	Cy
H1	0.3110	0.4780	H3	0.2847	0.4093
	0.3282	0.4714		0.3018	0.4027
	0.3150	0.4370		0.2887	0.3684
	0.2978	0.4436		0.2715	0.3750
H2	0.2978	0.4436	H4	0.2715	0.3750
	0.3150	0.4370		0.2887	0.3684
	0.3018	0.4027		0.2755	0.3340
	0.2847	0.4093		0.2583	0.3406

---

## Group Name on Label

**Example: AP-H1-L1**

Brightness

Color Chromaticity

Forward Voltage

---

AP

H1

L1

---

**Relative Spectral Emission** <sup>5)</sup>

$I_{rel} = f(\lambda); I_F = 700 \text{ mA}; T_J = 25 \text{ }^\circ\text{C}$

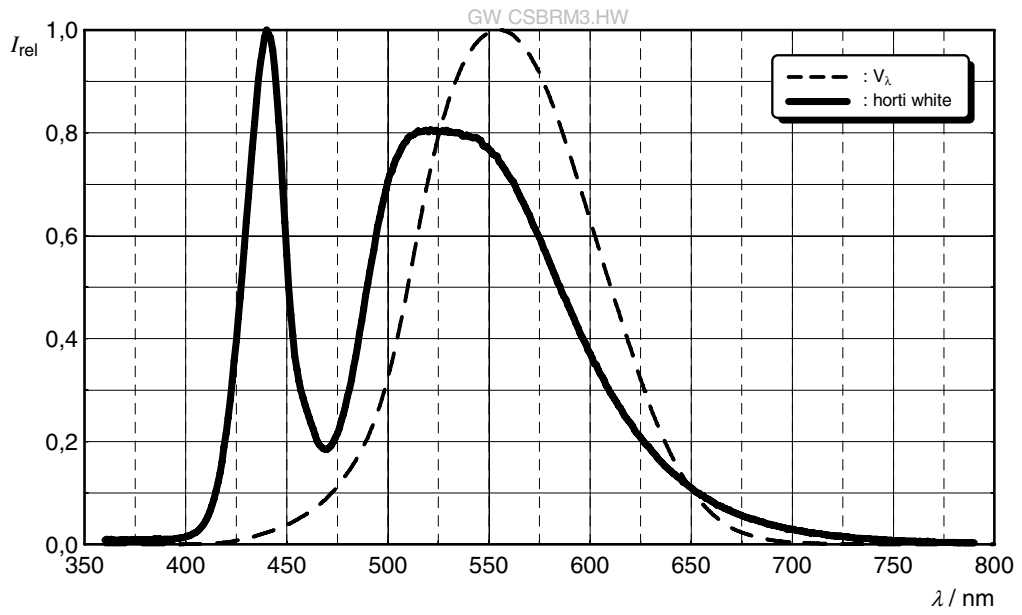

**Radiation Characteristics** <sup>5)</sup>

$I_{rel} = f(\phi); T_J = 25 \text{ }^\circ\text{C}$

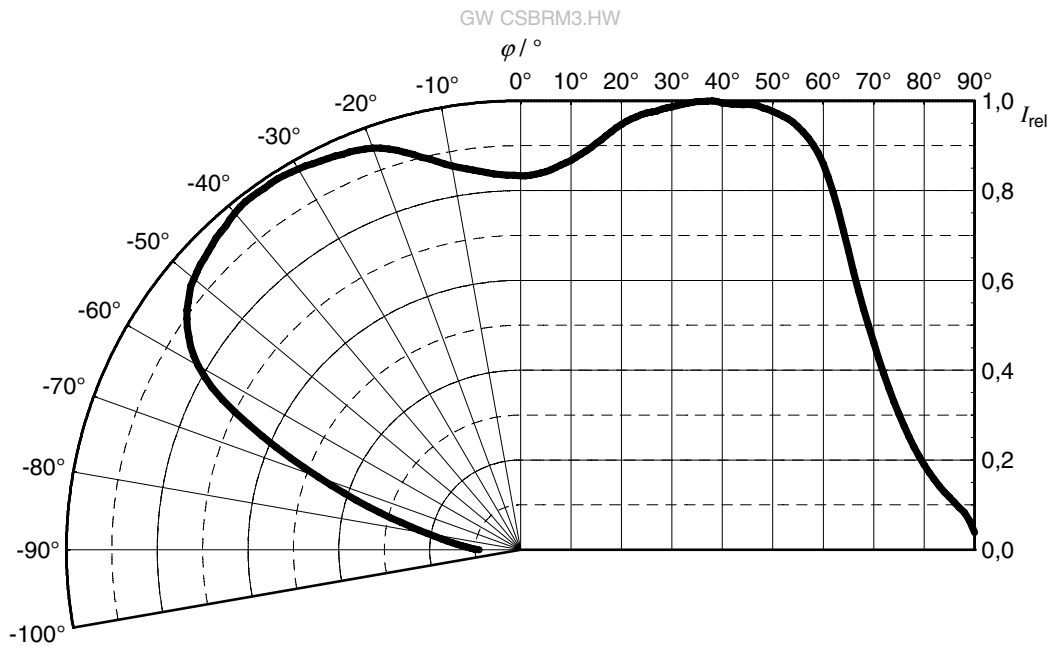



**Forward current** <sup>5)</sup>

$I_F = f(V_F); T_J = 25\text{ °C}$

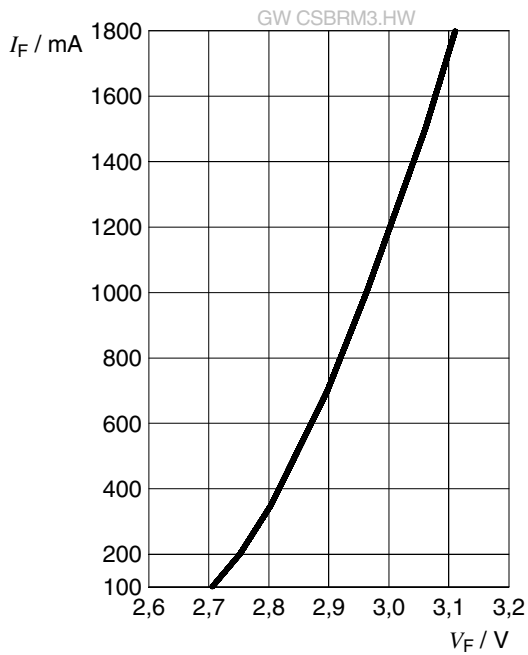

**Relative Radiant Power** <sup>5), 6)</sup>

$\Phi_E / \Phi_E(700\text{ mA}) = f(I_F); T_J = 25\text{ °C}$

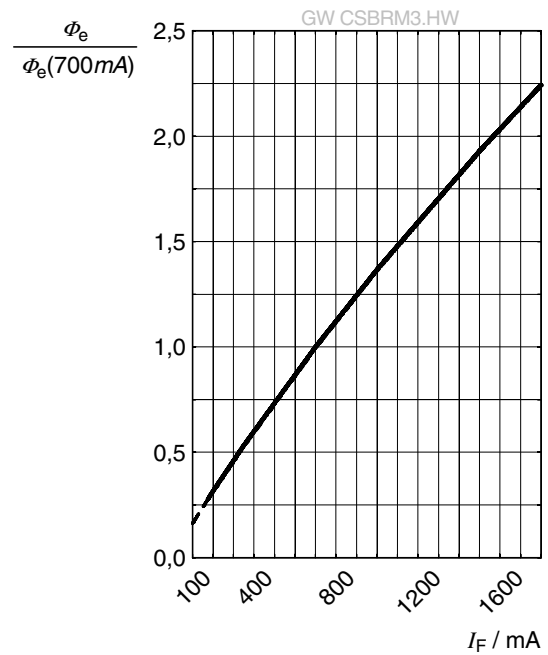

**Chromaticity Coordinate Shift** <sup>5)</sup>

$\Delta Cx, \Delta Cy = f(I_F); T_J = 25\text{ °C}$

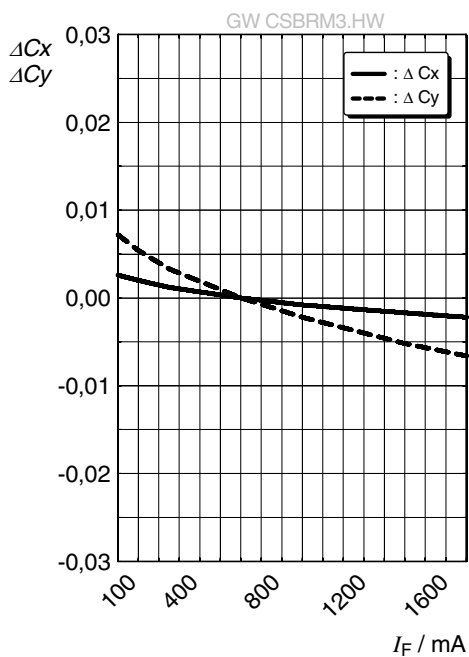

**Forward Voltage** <sup>5)</sup>

$\Delta V_F = V_F - V_F(25\text{ }^\circ\text{C}) = f(T_j); I_F = 700\text{ mA}$

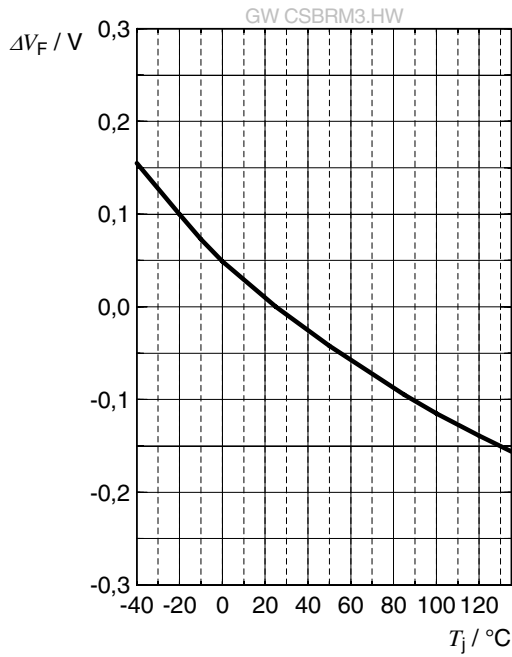

**Relative Radiant Power** <sup>5)</sup>

$\Phi_E / \Phi_E(25\text{ }^\circ\text{C}) = f(T_j); I_F = 700\text{ mA}$

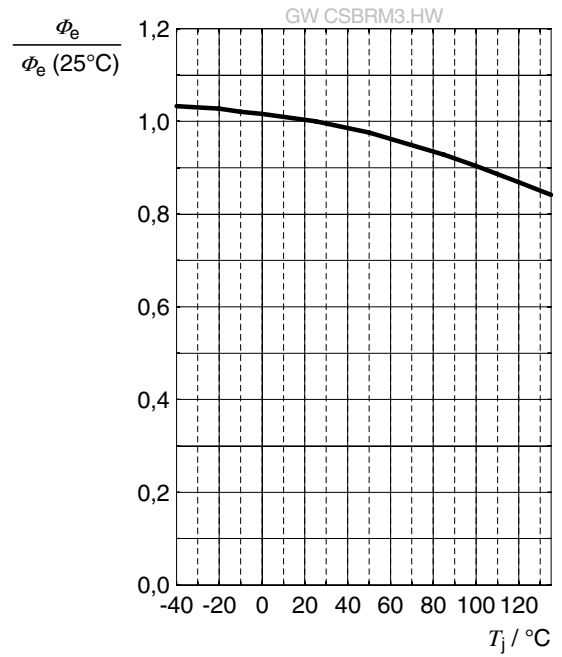

**Chromaticity Coordinate Shift** <sup>5)</sup>

$\Delta C_x, \Delta C_y = f(T_j); I_F = 700\text{ mA}$

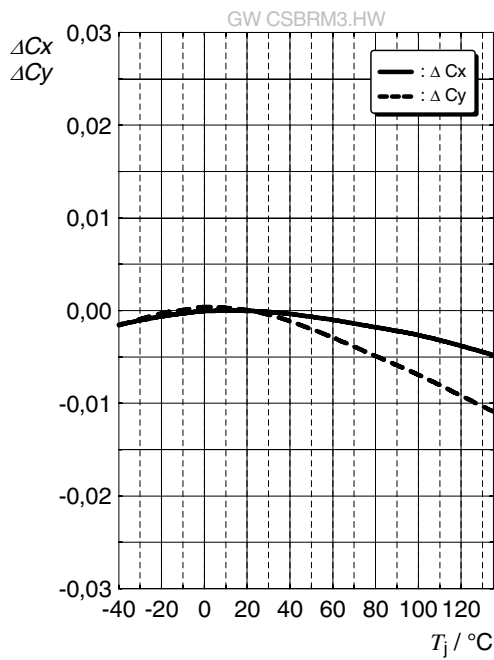

## Max. Permissible Forward Current

$$I_F = f(T)$$

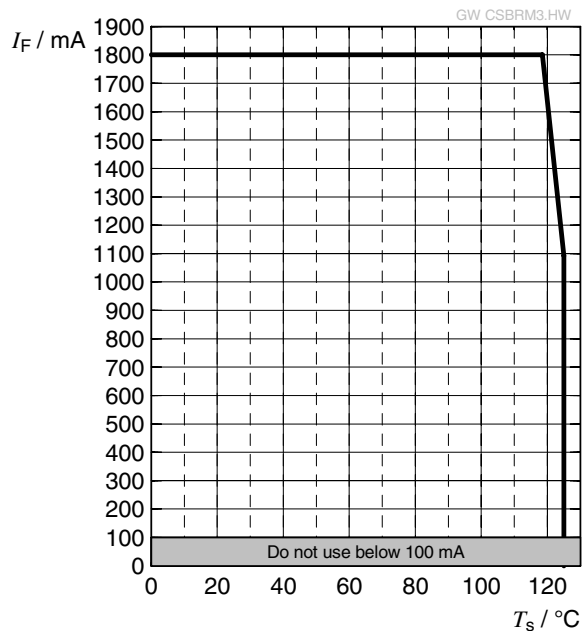

**Dimensional Drawing** <sup>7)</sup>

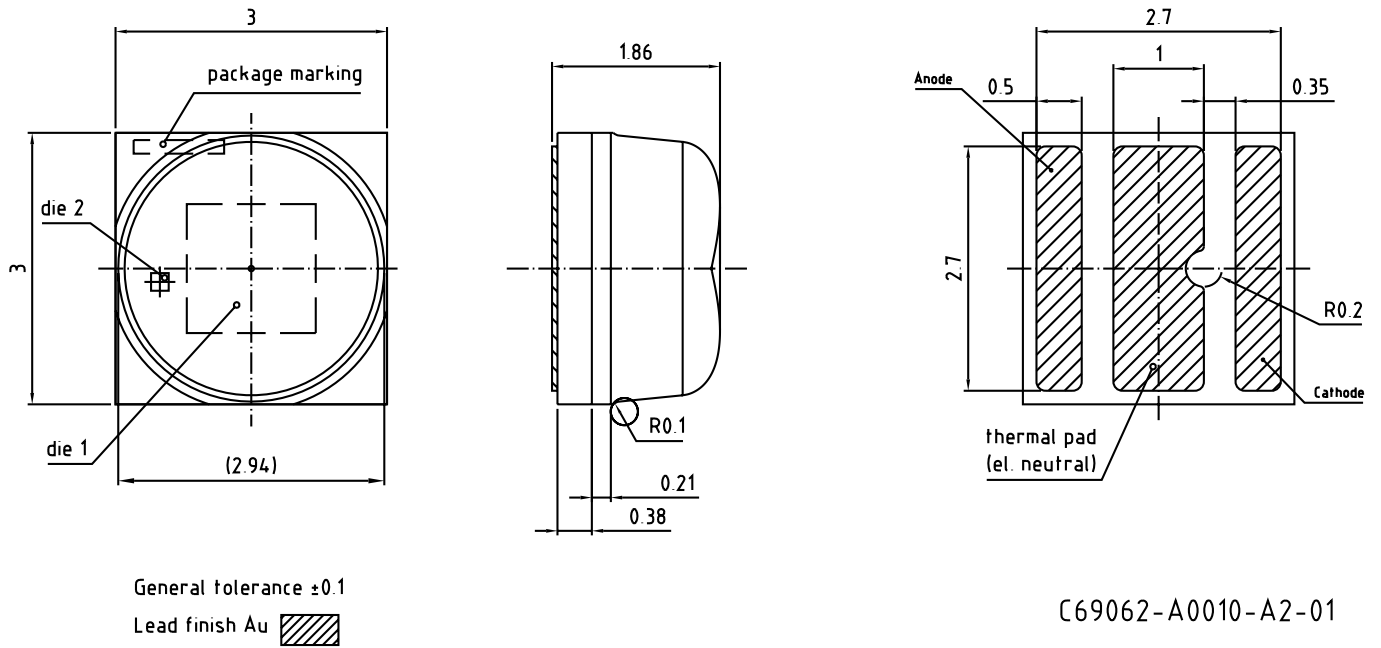

**Further Information:**

**Approximate Weight:** 27.0 mg

**Package marking:** Cathode

**Corrosion test:** Class: 3B  
 Test condition: 40°C / 90 % RH / 15 ppm H<sub>2</sub>S / 14 days (stricter than IEC 60068-2-43)

**ESD advice:** The device is protected by ESD device which is connected in parallel to the Chip.

## Recommended Solder Pad <sup>7)</sup>

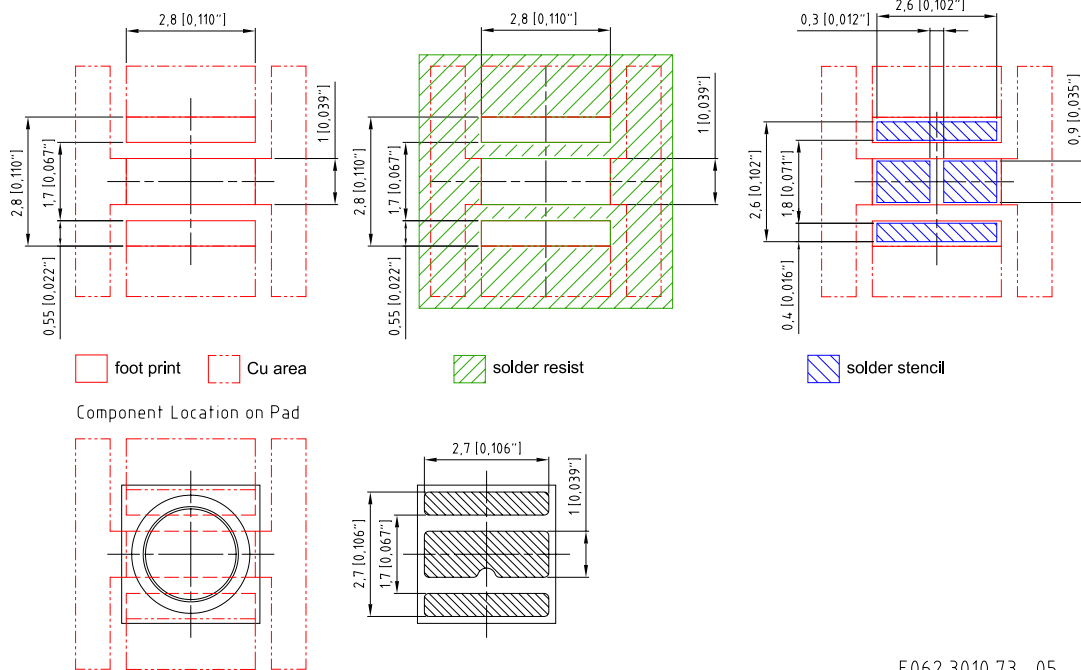

E062 3010.73 -05

For superior solder joint connectivity results we recommend soldering under standard nitrogen atmosphere. Further information can be found in our Application Note: "Handling and Processing Details for Ceramic LEDs".

## Reflow Soldering Profile

Product complies to MSL Level 2 acc. to JEDEC J-STD-020E

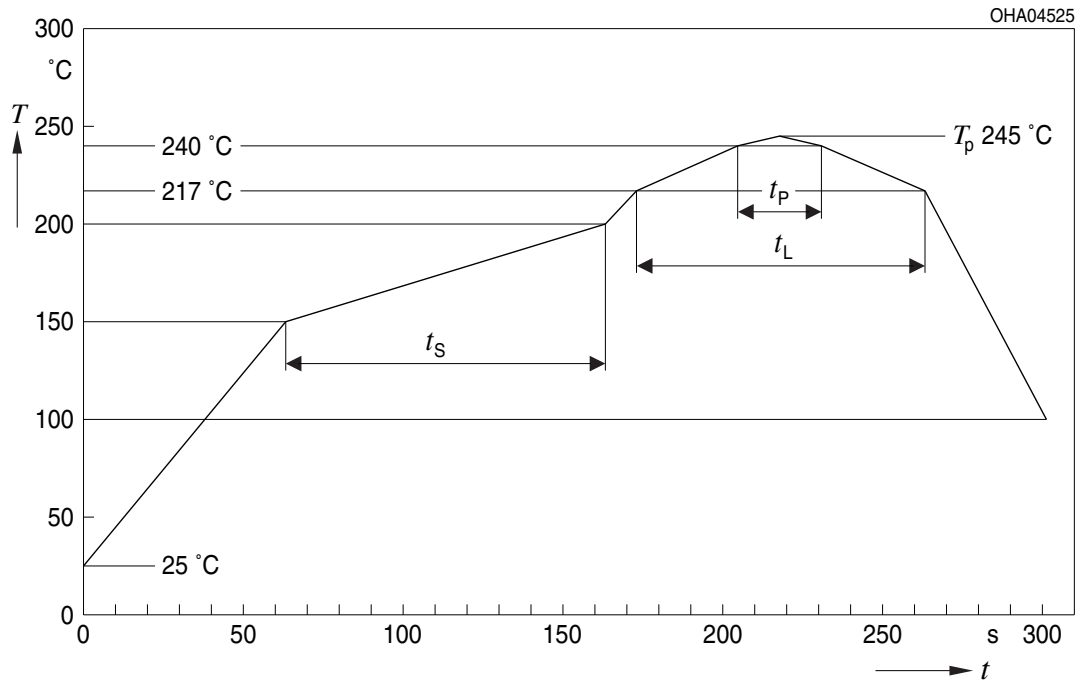

Profile Feature	Symbol	Pb-Free (SnAgCu) Assembly			Unit
		Minimum	Recommendation	Maximum	
Ramp-up rate to preheat <sup>*)</sup> 25 °C to 150 °C			2	3	K/s
Time $t_s$ $T_{Smin}$ to $T_{Smax}$	$t_s$	60	100	120	s
Ramp-up rate to peak <sup>*)</sup> $T_{Smax}$ to $T_p$			2	3	K/s
Liquidus temperature	$T_L$		217		°C
Time above liquidus temperature	$t_L$		80	100	s
Peak temperature	$T_p$		245	260	°C
Time within 5 °C of the specified peak temperature $T_p - 5$ K	$t_p$	10	20	30	s
Ramp-down rate* $T_p$ to 100 °C			3	6	K/s
Time 25 °C to $T_p$				480	s

All temperatures refer to the center of the package, measured on the top of the component

\* slope calculation  $DT/Dt$ :  $Dt$  max. 5 s; fulfillment for the whole T-range

Taping <sup>7)</sup>

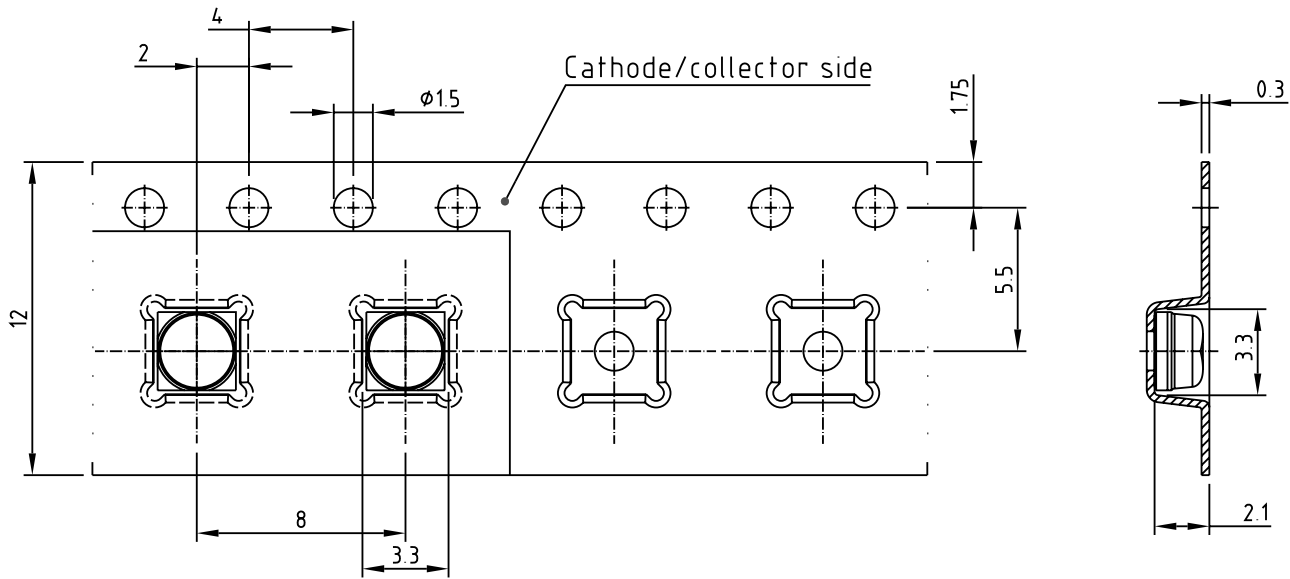

C69062-A0010-B7-01

**Tape and Reel** <sup>8)</sup>



**Reel Dimensions**

A	W	N <sub>min</sub>	W <sub>1</sub>	W <sub>2max</sub>	Pieces per PU
330 mm	12 + 0.3 / - 0.1 mm	60 mm	12.4 + 2 mm	18.4 mm	3000



### Barcode-Product-Label (BPL)

**OSRAM Opto Semiconductors** LX XXXX BIN1: XX-XX-X-XXX-X

RoHS Compliant

(6P) BATCH NO: 1234567890 ML Temp ST  
X XXX °C X

(1T) LOT NO: 1234567890 (9D) D/C: 1234 Pack: RXX  
DEMY XXX  
X\_X123\_1234.1234 X

(X) PROD NO: 123456789(Q)QTY: 9999 (G) GROUP: XX-XX-X-X

The diagram shows a rectangular label with rounded corners. It contains the OSRAM logo and product name at the top left. To the right are fields for 'LX XXXX' and 'BIN1: XX-XX-X-XXX-X'. Below the logo is a 'RoHS Compliant' statement. The label features three horizontal barcode sections. The first is labeled '(6P) BATCH NO: 1234567890' and is accompanied by a 'no liquid' symbol and 'ML Temp ST X XXX °C X'. The second is labeled '(1T) LOT NO: 1234567890' and '(9D) D/C: 1234' and is accompanied by 'Pack: RXX', 'DEMY XXX', and 'X\_X123\_1234.1234 X'. The third is labeled '(X) PROD NO: 123456789(Q)QTY: 9999' and '(G) GROUP: XX-XX-X-X'. A square QR code is located on the right side of the label.

OHA04563

### Dry Packing Process and Materials



OHA00539

Moisture-sensitive product is packed in a dry bag containing desiccant and a humidity card according JEDEC-STD-033.

## Notes

The evaluation of eye safety occurs according to the standard IEC 62471:2006 (photo biological safety of lamps and lamp systems). Within the risk grouping system of this IEC standard, the device specified in this data sheet fall into the class **moderate risk (exposure time 0.25 s)**. Under real circumstances (for exposure time, conditions of the eye pupils, observation distance), it is assumed that no endangerment to the eye exists from these devices. As a matter of principle, however, it should be mentioned that intense light sources have a high secondary exposure potential due to their blinding effect. When looking at bright light sources (e.g. headlights), temporary reduction in visual acuity and afterimages can occur, leading to irritation, annoyance, visual impairment, and even accidents, depending on the situation.

Subcomponents of this device contain, in addition to other substances, metal filled materials including silver. Metal filled materials can be affected by environments that contain traces of aggressive substances. Therefore, we recommend that customers minimize device exposure to aggressive substances during storage, production, and use. Devices that showed visible discoloration when tested using the described tests above did show no performance deviations within failure limits during the stated test duration. Respective failure limits are described in the IEC60810.

This device is designed for specific/recommended applications only. Please consult OSRAM Opto Semiconductors Sales Staff in advance for detailed information on other non-recommended applications (e.g. automotive).

Change management for this component is aligned with the requirements of the lighting market.

For further application related information please visit [www.osram-os.com/appnotes](http://www.osram-os.com/appnotes)

## Disclaimer

### **Attention please!**

The information describes the type of component and shall not be considered as assured characteristics. Terms of delivery and rights to change design reserved. Due to technical requirements components may contain dangerous substances.

For information on the types in question please contact our Sales Organization.

If printed or downloaded, please find the latest version on the OSRAM OS website.

### **Packing**

Please use the recycling operators known to you. We can also help you – get in touch with your nearest sales office. By agreement we will take packing material back, if it is sorted. You must bear the costs of transport. For packing material that is returned to us unsorted or which we are not obliged to accept, we shall have to invoice you for any costs incurred.

### **Product and functional safety devices/applications or medical devices/applications**

OSRAM OS components are not developed, constructed or tested for the application as safety relevant component or for the application in medical devices.

OSRAM OS products are not qualified at module and system level for such application.

In case buyer – or customer supplied by buyer – considers using OSRAM OS components in product safety devices/applications or medical devices/applications, buyer and/or customer has to inform the local sales partner of OSRAM OS immediately and OSRAM OS and buyer and /or customer will analyze and coordinate the customer-specific request between OSRAM OS and buyer and/or customer.

## Glossary

- 1) **Brightness:** Brightness values are measured during a current pulse of typically 10 ms, with a tolerance of +/- 7%.
- 2) **Reverse Operation:** Not designed for reverse operation. Continuous reverse operation can cause migration and damage of the device.
- 3) **Forward Voltage:** The Forward voltage is measured during a current pulse duration of typically 1 ms with a tolerance of  $\pm 0.05V$  .
- 4) **Chromaticity coordinate groups:** Chromaticity coordinate groups are measured during a current pulse duration of typically 10ms with a tolerance of  $\pm 0.005$ .
- 5) **Typical Values:** Due to the special conditions of the manufacturing processes of semiconductor devices, the typical data or calculated correlations of technical parameters can only reflect statistical figures. These do not necessarily correspond to the actual parameters of each single product, which could differ from the typical data and calculated correlations or the typical characteristic line. If requested, e.g. because of technical improvements, these typ. data will be changed without any further notice.
- 6) **Characteristic curve:** In the range where the line of the graph is broken, you must expect higher differences between single devices within one packing unit.
- 7) **Tolerance of Measure:** Unless otherwise noted in drawing, tolerances are specified with  $\pm 0.1$  and dimensions are specified in mm.
- 8) **Tape and Reel:** All dimensions and tolerances are specified acc. IEC 60286-3 and specified in mm.

## Revision History

Version	Date	Change
1.0	2021-09-22	Initial Version
1.1	2021-10-06	Characteristics

Published by OSRAM Opto Semiconductors GmbH EU RoHS and China RoHS compliant product  
Leibnizstraße 4, D-93055 Regensburg  
www.osram-os.com © All Rights Reserved.



此产品符合欧盟 RoHS 指令的要求；  
按照中国的相关法规和标准，不含有毒有害物质或元素。