

SKKH 75/16 E



SEMIPACK® 1

Thyristor / Diode Modules

SKKH 75/16 E

Features*

- Heat transfer through aluminium oxide ceramic insulated metal baseplate
- UL recognized, file no. E63532

Typical Applications

- Rectifier for motor drives
- Process control
- Rectifier for power supplies

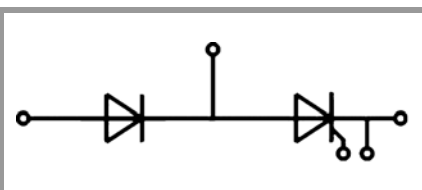

SKKH

Absolute Maximum Ratings				
Symbol	Conditions		Values	Unit
Thyristor / diode				
$I_{F(AV)}/I_{T(AV)}$	sin. 180°	$T_c = 85\text{ °C}$	75	A
	$T_j = 130\text{ °C}$	$T_c = 100\text{ °C}$	57	A
I_{FSM}/I_{TSM}	$t_p = 10\text{ ms}$	$T_j = 25\text{ °C}$	1500	A
		$T_j = 130\text{ °C}$	1200	A
i^2t	$t_p = 10\text{ ms}$	$T_j = 25\text{ °C}$	11250	A ² s
		$T_j = 130\text{ °C}$	7200	A ² s
V_{RSM}	$T_j = 25\text{ °C}$, thyristor, diode		1700	V
V_{RRM}	$T_j = 25\text{ °C}$, thyristor, diode		1600	V
V_{DRM}	$T_j = 25\text{ °C}$, thyristor		1600	V
$(di/dt)_{cr}$	$T_j = 130\text{ °C}$, thyristor		140	A/ μ s
$(dv/dt)_{cr}$	$T_j = 130\text{ °C}$, thyristor		1000	V/ μ s
T_j			-40 ... 130	°C
Module				
T_{stg}			-40 ... 125	°C
V_{isol}	a.c.; 50 Hz; r.m.s.	1 min	3000	V
		1 s	3600	V

Characteristics						
Symbol	Conditions		min.	typ.	max.	Unit
Thyristor						
V_T	$T_j = 25\text{ °C}$, $I_T = 225\text{ A}$				1.81	V
$V_{T(TO)}$	$T_j = 130\text{ °C}$				0.92	V
r_T	$T_j = 130\text{ °C}$				4.6	m Ω
$I_{DD}; I_{RD}$	$T_j = 130\text{ °C}$, $V_{DD} = V_{DRM}$; $V_{RD} = V_{RRM}$				15	mA
t_{gd}	$I_G = 1\text{ A}$	$T_j = 25\text{ °C}$		1		μ s
t_{gr}	$di_G/dt = 1\text{ A}/\mu\text{s}$ $V_D = 0.67 * V_{DRM}$	$T_j = 25\text{ °C}$		2		μ s
t_q	$T_j = 130\text{ °C}$			200		μ s
I_H	$T_j = 25\text{ °C}$				220	mA
I_L	$T_j = 25\text{ °C}$, $R_G = 33\text{ }\Omega$				550	mA
V_{GT}	$T_j = 25\text{ °C}$, d.c.		2.5			V
I_{GT}	$T_j = 25\text{ °C}$, d.c.		100			mA
V_{GD}	$T_j = 130\text{ °C}$, d.c.				0.25	V
I_{GD}	$T_j = 130\text{ °C}$, d.c.				4	mA
$R_{th(j-c)}$	cont., per chip				0.23	K/W
	sin. 180°, per chip				0.3	K/W
	rec. 120°, per chip				0.32	K/W
Diode						
V_F	$T_j = 25\text{ °C}$, $I_F = 225\text{ A}$				1.65	V
V_{F0}	$T_j = 130\text{ °C}$				0.85	V
r_F	$T_j = 130\text{ °C}$				3.90	m Ω
I_R	$T_j = 130\text{ °C}$, $V_{RD} = V_{RRM}$				1.7	mA
$R_{th(j-c)}$	cont., per chip				0.3	K/W
	sin. 180°, per chip				0.38	K/W
	rec. 120°, per chip				0.4	K/W

SKKH 75/16 E



SEMIPACK® 1

Characteristics					
Symbol	Conditions	min.	typ.	max.	Unit
Module					
$R_{th(c-s)}$	thyristor, P12 (reference)		0.09		K/W
	diode, P12 (reference)		0.09		K/W
	module, P12 (reference)		0.05		K/W
M_s	to heatsink M5	4.25		5.75	Nm
M_t	to terminals M5	2.55		3.45	Nm
a				5 * 9.81	m/s ²
w			75		g

Thyristor / Diode Modules

SKKH 75/16 E

Features*

- Heat transfer through aluminium oxide ceramic insulated metal baseplate
- UL recognized, file no. E63532

Typical Applications

- Rectifier for motor drives
- Process control
- Rectifier for power supplies

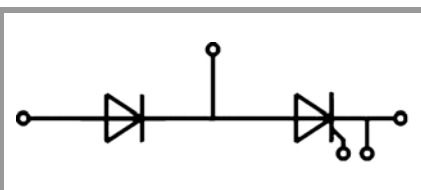

SKKH

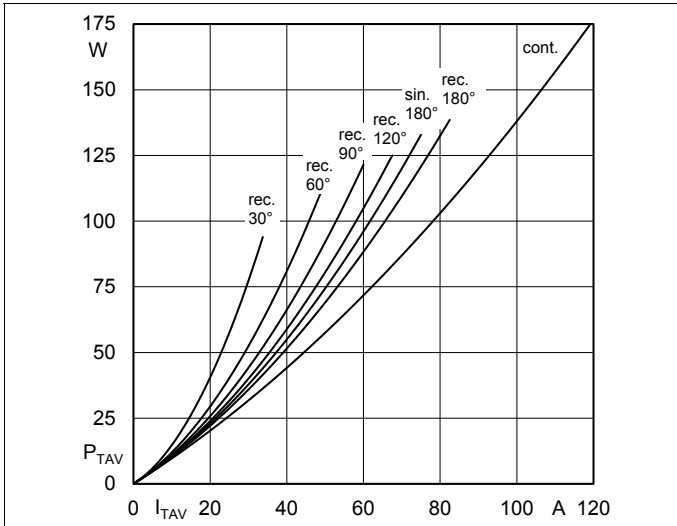

Fig. 1L: Power dissipation per thyristor vs. on-state current

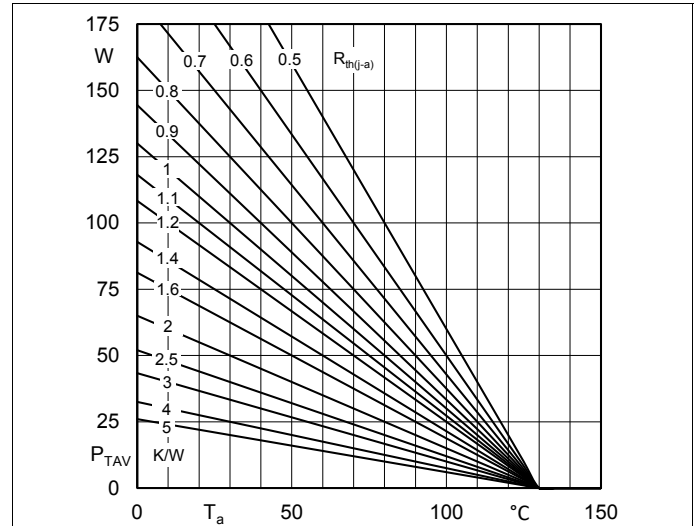

Fig. 1R: Max. power dissipation per thyristor vs. ambient temperature

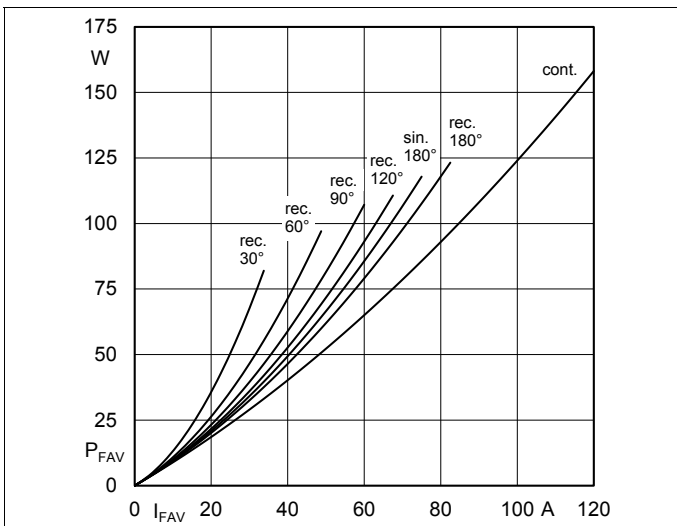

Fig. 2L: Power dissipation per diode vs. forward current

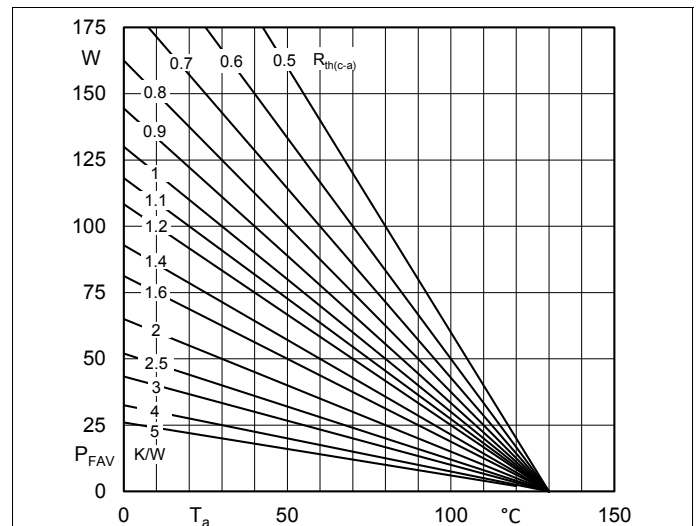

Fig. 2R: Max. power dissipation per diode vs. ambient temperature

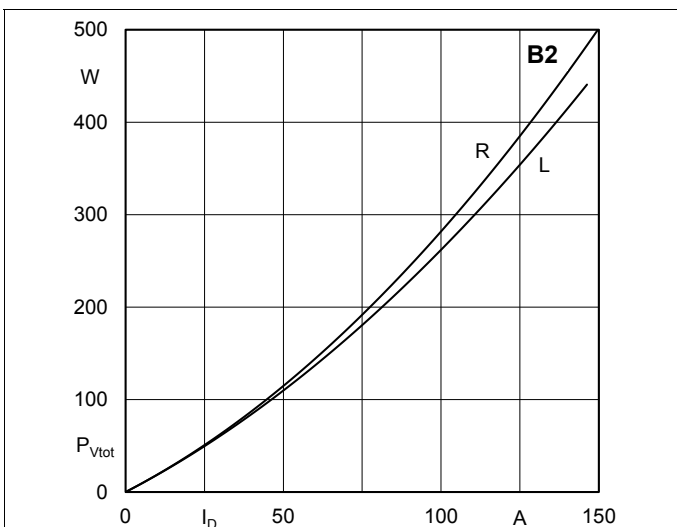

Fig. 3L: Max. power dissipation of two modules vs. direct current

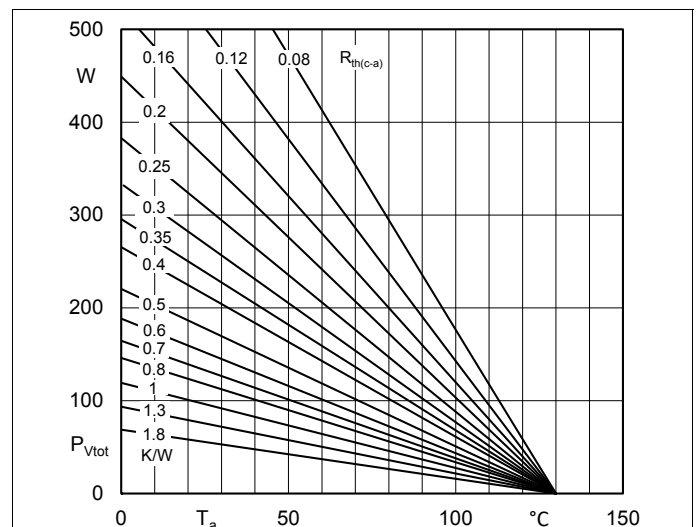

Fig. 3R: Max. power dissipation of two modules vs. ambient temperature

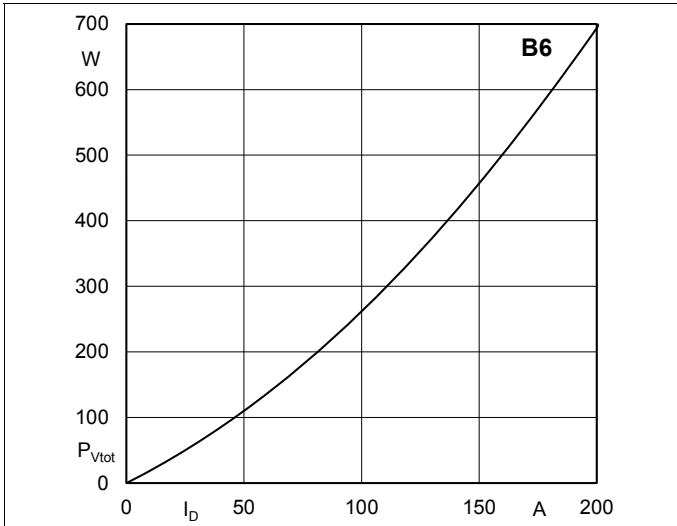

Fig. 4L: Max. power dissipation of three modules vs. direct current

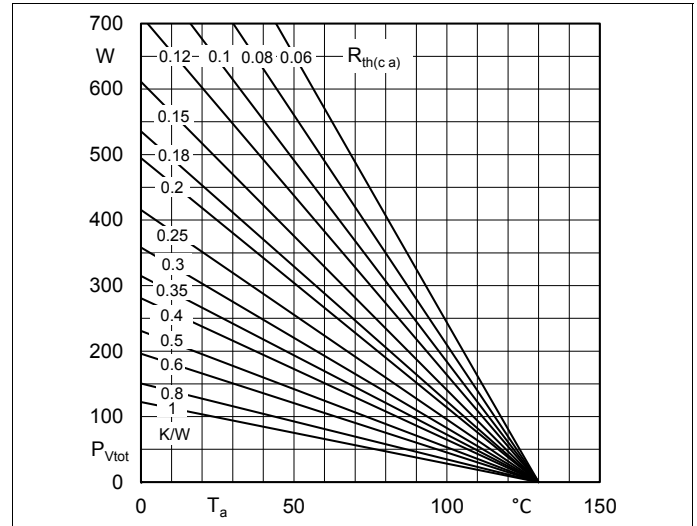

Fig. 4R: Max. power dissipation of three modules vs. ambient temperature

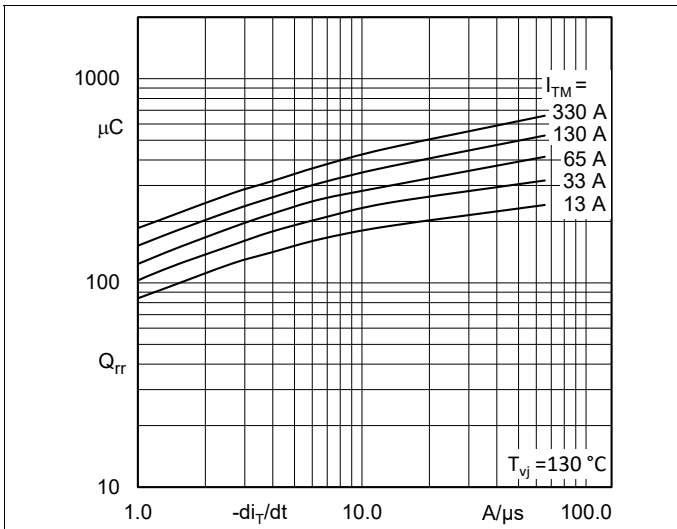

Fig. 5: Recovered charge vs. current decrease

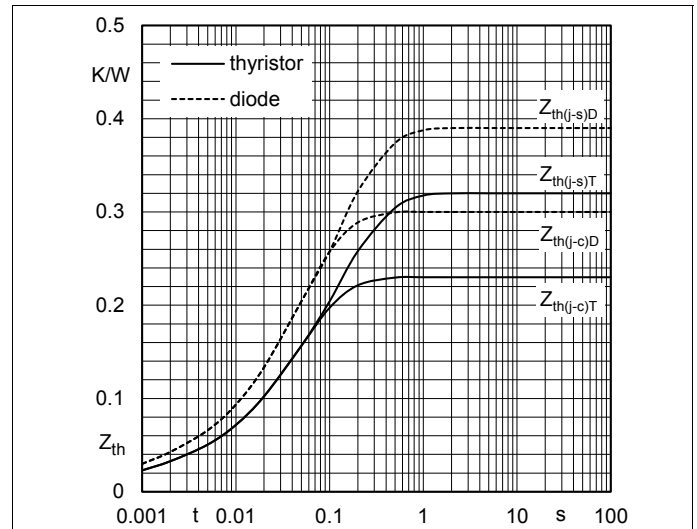

Fig. 6: Transient thermal impedance vs. time

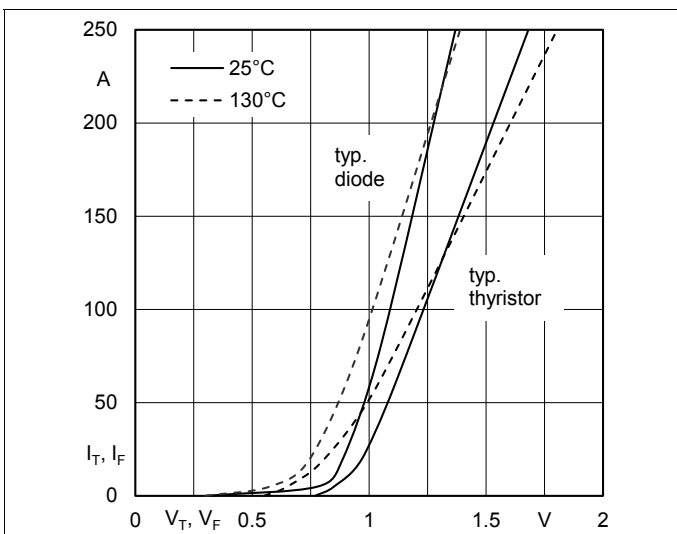

Fig. 7: On-state characteristics

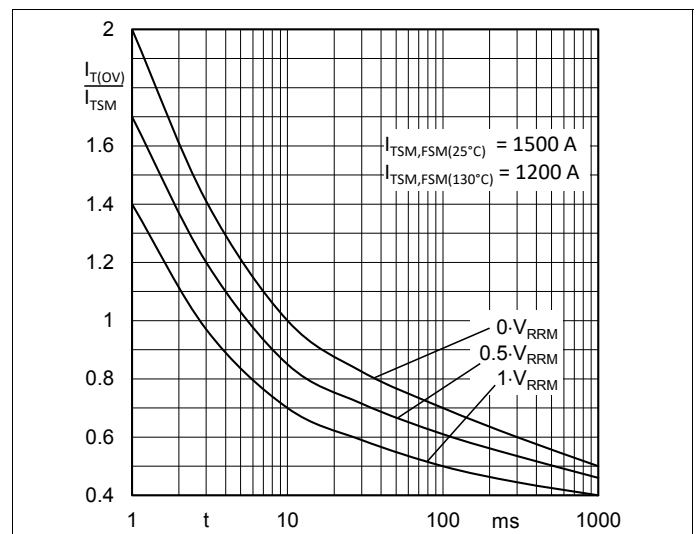

Fig. 8: Surge overload current vs. time

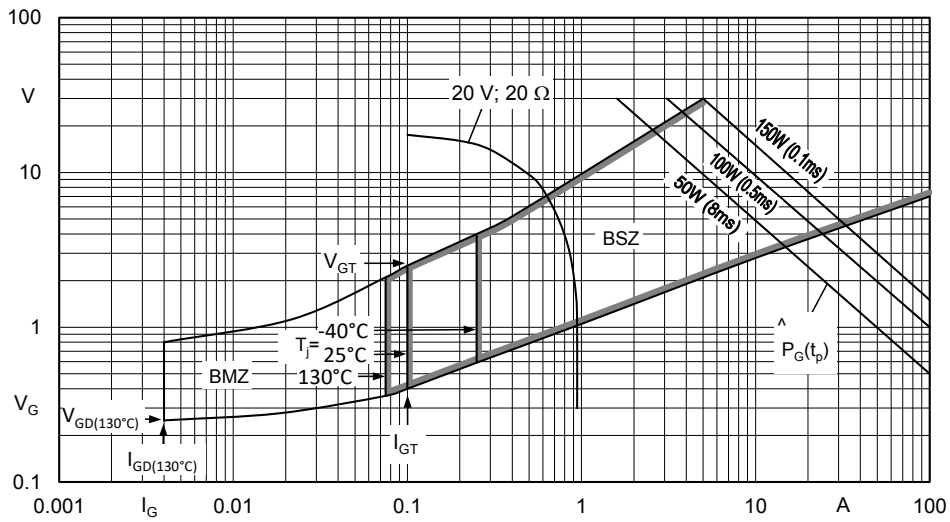
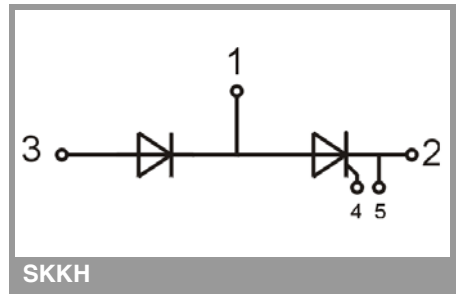
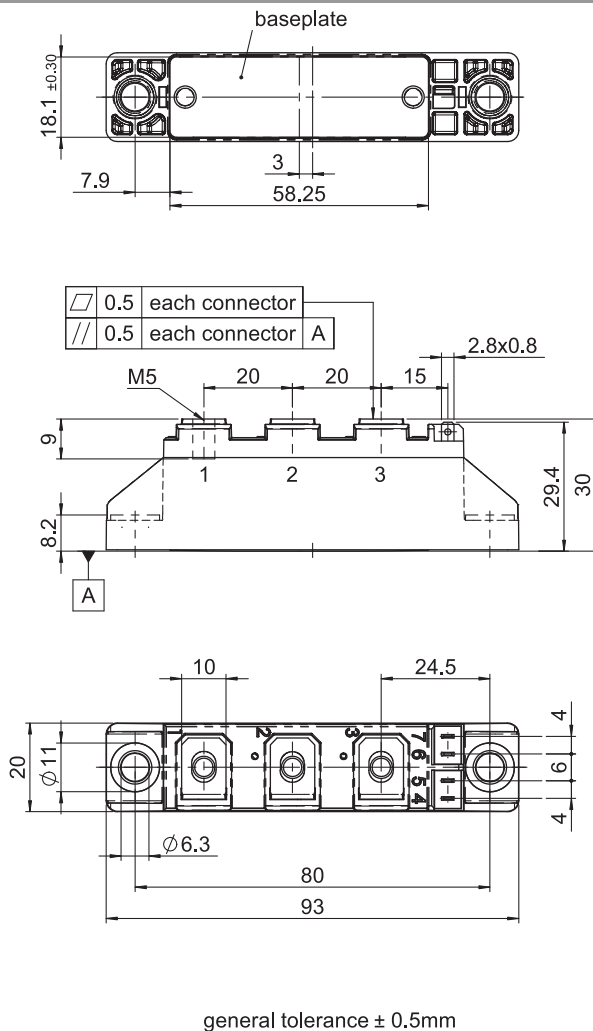

Fig. 9: Gate trigger characteristics



SKKH

IMPORTANT INFORMATION AND WARNINGS

This is an electrostatic discharge sensitive device (ESDS) according to international standard IEC 61340.

*The specifications of Semikron Danfoss products may not be considered as any guarantee or assurance of product characteristics ("Beschaffheitsgarantie"). The specifications of Semikron Danfoss products describe only the usual characteristics of Semikron Danfoss products to be expected in typical applications, which may still vary depending on the specific application. Therefore, products must be tested

for the respective application in advance. Resulting from this, application adjustments of any kind may be necessary. Any user of Semikron Danfoss products is responsible for the safety of their applications embedding Semikron Danfoss products and must take adequate safety measures to prevent the applications from causing any physical injury, fire or other problem, also if any Semikron Danfoss product becomes faulty. Any user is responsible for making sure that the application design and realization are compliant with all laws, regulations, norms and standards applicable to the scope of application. Unless otherwise explicitly approved by Semikron Danfoss in a written document signed by authorized representatives of Semikron Danfoss, Semikron Danfoss products may not be used in any applications where a failure of the product or any consequences of the use thereof can reasonably be expected to result in personal injury. No representation or warranty is given and no liability is assumed with respect to the accuracy, completeness and/or use of any information herein, including without limitation, warranties of non-infringement of intellectual property rights of any third party. Semikron Danfoss does not convey any license under its or a third party's patent rights, copyrights, trade secrets or other intellectual property rights, neither does it make any representation or warranty of non-infringement of intellectual property rights of any third party which may arise from a user's applications.