

*Application

- 1.Floppy disk drives, Camera.
2. Various microcomputerized control equipment.

*Dimensions

Note: All units are in millimeters unless otherwise indicated.

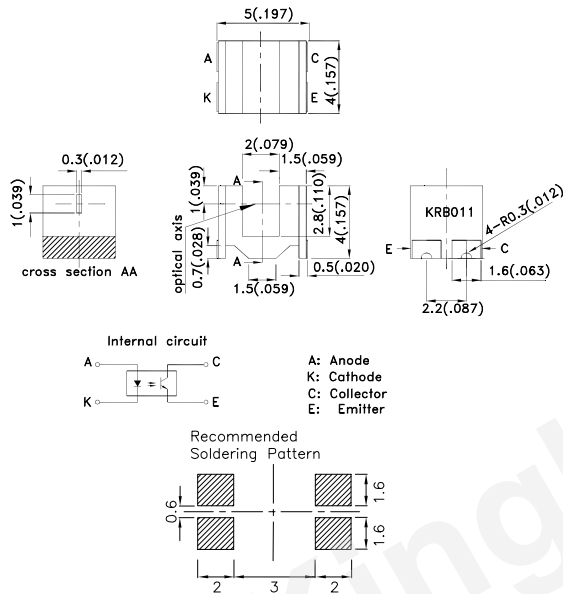

Unless otherwise, the tolerances are $\pm 0.15\text{mm}$.

*Features

1. Ultra-compact.
2. High sensing accuracy (Slit width: 0.3mm).
3. Gap between light emitter and detector: 2mm.
4. Moisture Sensitivity Level : Level 4.
5. RoHS compliant.

*Absolute Maximum Ratings ($T_a=25^\circ\text{C}$)

Parameter		Symbol	Rating	Unit
Input	Forward current[1]	I_F	25	mA
	Reverse voltage	V_R	5	V
	Power dissipation	P_d	35	mW
Output	Collector-emitter voltage	V_{CEO}	20	V
	Emitter-collector voltage	V_{ECO}	5	V
	Collector current	I_C	20	mA
	Collector power dissipation	P_C	75	mW
Operating temperature		T_{opr}	-30~+85	$^\circ\text{C}$
Storage temperature		T_{stg}	-40~+90	$^\circ\text{C}$
Soldering temperature[2]		T_{sol}	260	$^\circ\text{C}$
Manual soldering[2]		T_{sol}	300	$^\circ\text{C}$

Notes:

1. Refer to the temperature rating chart if the ambient temperature exceeds 25°C .
2. Complete soldering within 10 seconds for reflow soldering and within 3 seconds for manual soldering.

*Electrical / Optical Characteristics at $T_A=25^\circ\text{C}$

Parameter	Symbol	Value			Conditions	
		Min.	Typ.	Max.		
Input	Forward voltage	V_F	-	1.1V	1.3V	$I_F=5\text{mA}$
	Reverse current	I_R	-	-	$10\mu\text{A}$	$V_R=5\text{V}$
	Peak Wavelength	λ_p	-	940nm	-	-
Output	Collector current	I_C	$50\mu\text{A}$	$650\mu\text{A}$	-	$I_F=5\text{mA}, V_{CE}=5\text{V}$
	Collector dark current	I_D	-	-	100nA	$V_{CE}=10\text{V}$
	Collector-emitter saturation voltage	$V_{CE(sat)}$	-	0.1V	0.4V	$I_C=50\mu\text{A}, I_F=20\text{mA}$
	Peak spectral sensitivity wavelength	λ_p	-	920nm	-	-
Rise time	t_r	-	$8\mu\text{sec}$	-	$V_{CC}=5\text{V},$ $R_L=1\text{K}\Omega$ $I_C=100\mu\text{A}$	
Fall time	t_f	-	$10\mu\text{sec}$	-		

Fig.1 Forward Current vs. Forward Voltage(Typical)

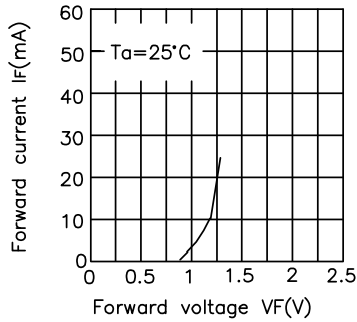

Fig.2 Collector Current vs. Forward Current

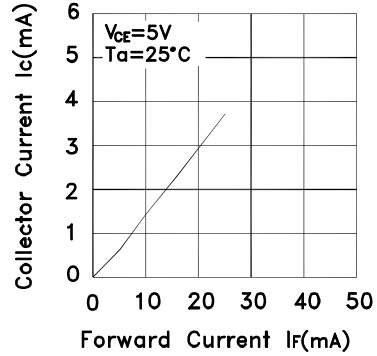

Fig.3 Collector Current vs. Ambient Temperature

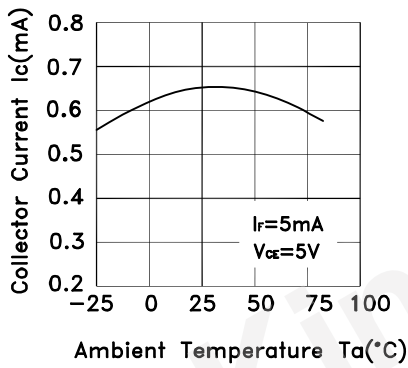

Fig.4 Collector-Emitter Saturation Voltage vs.Ambient Temperature

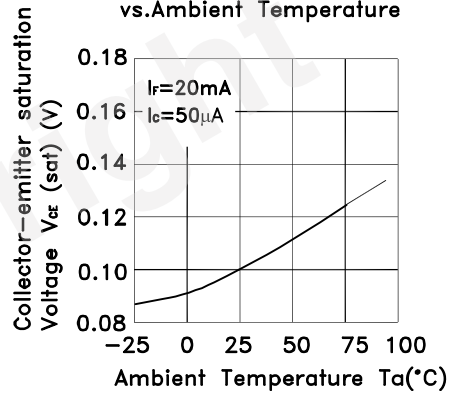

Fig.5 Forward Current vs. Collector Dissipation Temperature Rating (Typical)

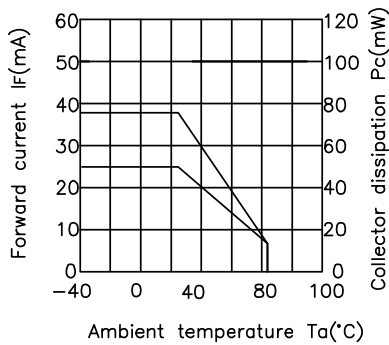

Fig.6 Collector Current vs. Collector-Emitter Voltage (Typical)

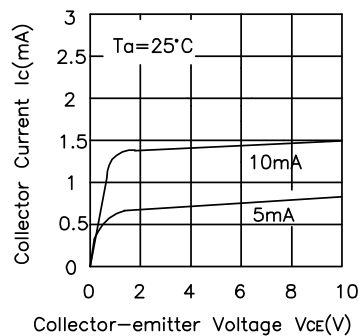

Fig.7 Relative Collector Current vs. Shield Distance(1) (Typical)

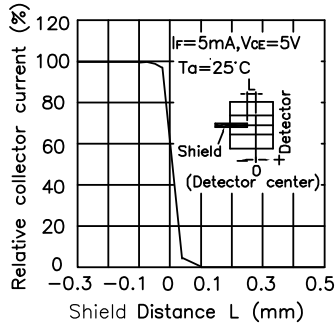

Fig.8 Relative Collector Current vs. Shield Distance(2) (Typical)

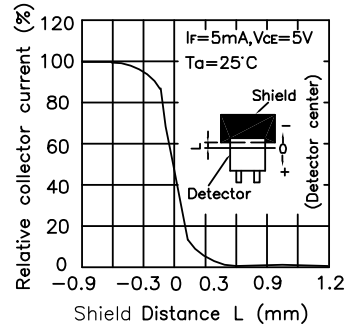
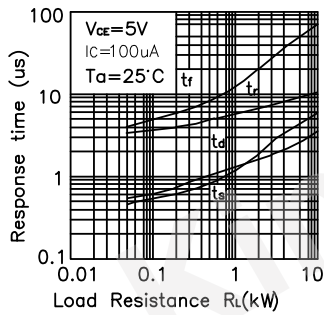
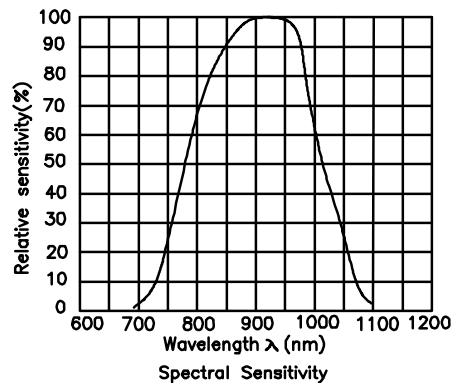
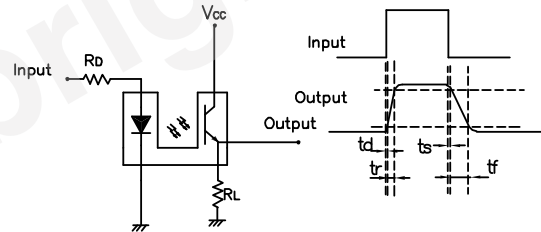

Fig.9 Response Time. vs. Load Resistance(Typical)



Test Circuit for Response Time



Reel Dimensions (Units : mm)

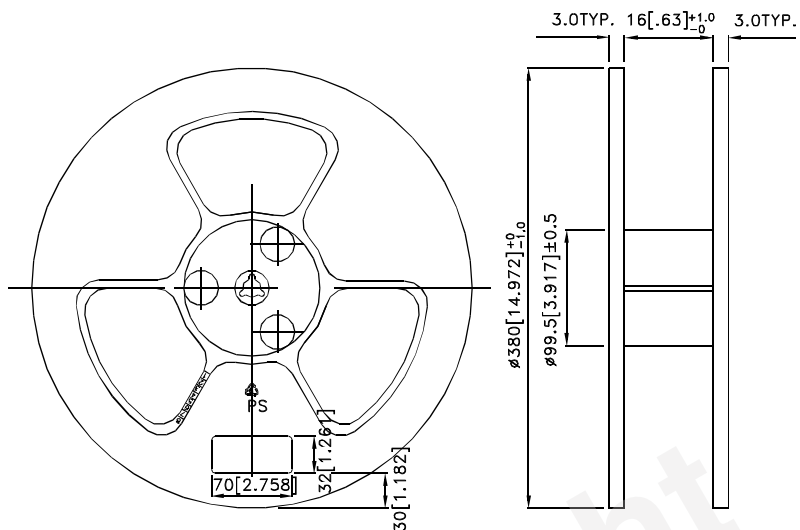

Tape Specifications (Units : mm)

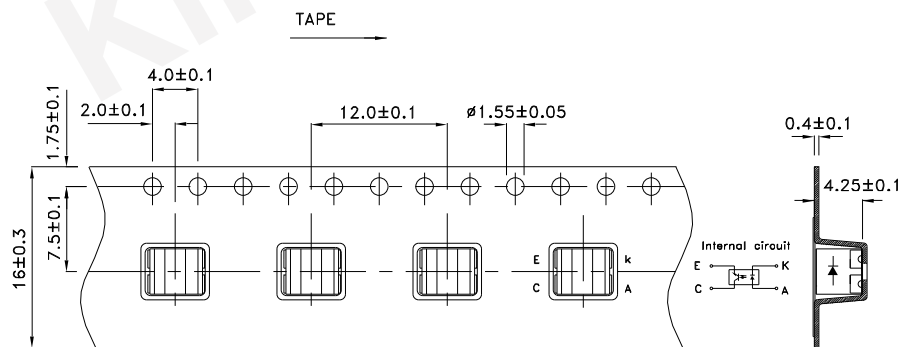

Tape quantity 1500pcs/reel

Reflow Soldering Profile For Lead-free SMT Process.

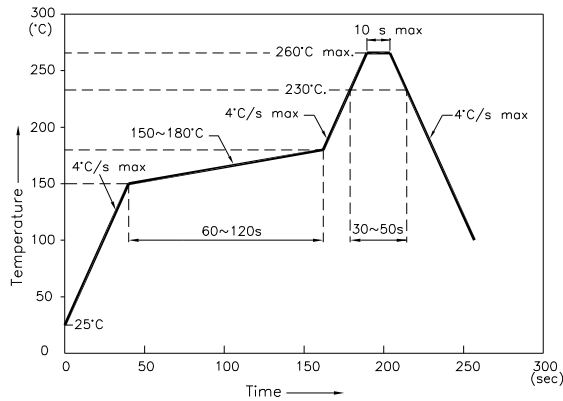



NOTES:

1. We recommend the reflow temperature 245°C(+/-5°C). The maximum soldering temperature should be limited to 260°C.
2. Don't cause stress to the epoxy resin while it is exposed to high temperature.
3. Number of reflow process shall be 2 times or less.

PACKING & LABEL SPECIFICATIONS

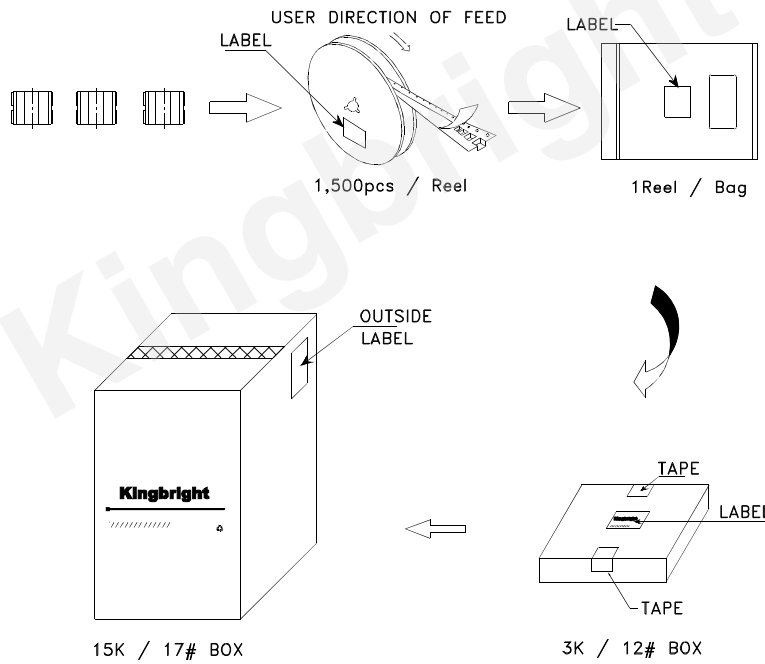
KRB011



Kingbright	
P/NO: KRB011	
QTY: 1,500 pcs	Q.C. Q C XX XX XXXX PASSED
S/N: XXXX	
CODE: XXX	
LOT NO: 	
RoHS Compliant	