

Multi Control Devices TACT Switch™ 4-direction with Center-push Function (Surface mount type)

SKRH Series



Body height of 1.85mm available with long-life of 1mil life cycles.

Multi Control
Devices

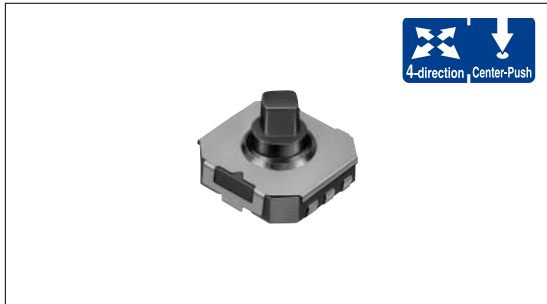

Product Line

Product No.	Operating force		Travel (mm)		Rating (max.)	Rating (min.)	Operating life (5mA 5V DC)	Initial contact resistance	Stem color	Variety	Minimum order unit (pcs.)
	4-direction	Center push	4-direction	Center push							
SKRHAAE010	1.23N	2.35N	0.25	0.15	50mA	10μA	200,000 cycles for each direction	500m max.	Black	Without guide bosses	1,300
SKRHABE010										With guide bosses	
SKRHACE010	1.2N	2.35N	0.25	0.15	50mA	10μA	1,000,000 cycles for each direction	100m max.	Natural	Without guide bosses	
SKRHAE010										With guide bosses	

Specification of Embossed Taping Package (Taping Packaging for Auto-insertion)

Reel Size

Unit:mm

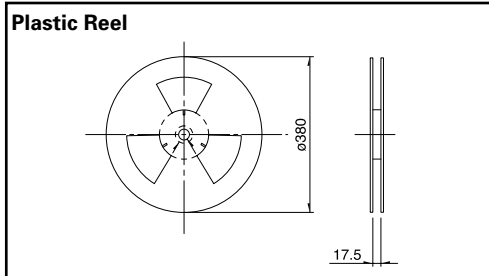

Number of packages (pcs.)			Tape width (mm)
1 reel	1 case /Japan	1 case /export packing	
1,300	10,400	10,400	16

Variable Resistor Type
Switch Type

Dimensions

Unit:mm

Style	PC board mounting hole and land dimensions (Viewed from mounting face)				
	x	h	a	b	c
SKRHAAE010	7.35	1.8	2.14	1	8.6
SKRHABE010	7.35	1.8	2.14	1	8.6
SKRHACE010	7.45	1.85	2.17	1.6	8.7
SKRHAE010	7.45	1.85	2.17	1.6	8.7

Circuit Diagram

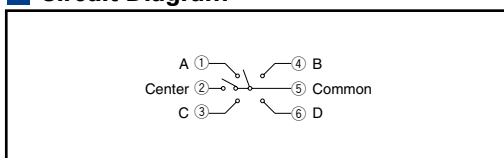













Notes

1. Please place purchase orders for taping products per minimum order unit (1 reel or 1 case).
2. 4-directional operating force and travel are measured at 4.3mm height from the bottom of the switch.

Refer to P.492 for soldering conditions.

List of Varieties

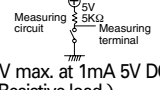
Series		Switch type						
		RKJXT1F	RKJXM	RKJXL	RKJXS	SKRV	SKRH	
Items		SKRHAA, SKRHAB		SKRHAC, SKRHAD				
Photo								
Function								
Dimensions (typical value) (mm)	W	17	20.5	13	11.7	6.45	7.35/7.45	
	D				12.3	6.4	7.5	
	H	10.5	5.45	6.4	2.3	4	5	
Outlined specifications	Number of operating shafts	Single-shaft	Single-shaft/Dual-shaft	Single-shaft				
	Shaft material	Metal			Resin			
	Directional resolution	4-direction	8-direction			4-direction		
	Directional operating feeling (tactile feeling)	With		Without	With			
	Lever return mechanism	With						
	Center-push switch	With						
	Encoder	With	Without/With	Without				
Operating temperature range	-40 to +85	-30 to +80	-30 to +70	-20 to +70		-30 to +85		
Rating (max. χ Resistive load)	10mA 5V DC				50mA 12V DC			
Electrical performance	Output voltage	 1V max. at 1mA 5V DC (Resistive load)						
	Directional resolution	4-direction	8-direction			4-direction		
	Insulation resistance	100M min. 250V DC			50M min. 50V DC	100M min. 100V DC		
	Voltage proof	300V AC for 1min. or 360V AC for 2s			50V AC for 1min.	100V AC for 1min.		
	Directional operating force	40 ± 25mN·m	Direction A, B, C, D 30 ± 20mN·m Direction AB, BC, CD, DA 25 ± 20mN·m	10 ± 7mN·m	0.8 ± 0.5N	1.2 ± 0.6N	1.23 ± 0.69N 1.2 ± 0.69N	
Mechanical performance	Push operating force	5 ± 2N	3 ± 1.5N	4.5 ± 1N	2.5 ± 1.5N	2.4 ± 0.69N	2.35 ± 0.69N	
	Encoder detent torque	15 ± 8mN·m	12 ± 8mN·m					
	Terminal strength	5N for 1min.						
	Actuator strength	Pushing direction	100N			30N		
		Operating direction	0.4N·m	0.3N·m	0.15N·m	20N		
Endurance	Vibration	8.3 ± 1 to 200 ± 4 to 8.3 ± 1Hz, 4.4G fixed (for 15 min./1 cycle) 3 angles each 2 hours				10 to 55 to 10Hz/min., the amplitude is 1.5mm for all the frequencies, in the 3 direction of X, Y and Z for 2 hours respectively		
	Operating life without load							
	Operating life with load (at rated load)							
Environmental performance	Cold	-40 ± 2 for 500h			-40 ± 2 for 96h	-30 ± 2 for 96h		
	Dry heat	85 ± 2 for 500h			85 ± 2 for 96h	80 ± 2 for 96h		
	Damp heat	60 ± 2, 90 to 95%RH for 500h			60 ± 2, 90 to 95%RH for 96h			
Soldering	Manual soldering	350 ± 5 3s max.			350 ± 10 3 ^s	350 max. 3s max.		
	Dip soldering	260 ± 5, 5 ± 1s		260 max. 6s max.				
	Reflow soldering	Please see P.492						
Page		475	476	478	479	480	481	

Switch Type Multi Control Devices Soldering Conditions492
 Switch Type Multi Control Devices Cautions493

Multi Control Devices

Variable Resistor Type

Switch Type

Soldering Conditions

Example of Reflow Soldering Condition

1. Heating method: Double heating method with infrared heater.
2. Temperature measurement: Thermocouple 0.1 to 0.2 CA(K) or CC(T) at solder joints copper foil surface) A heat resistive tape should be used to fix thermocouple.
3. Temperature profile

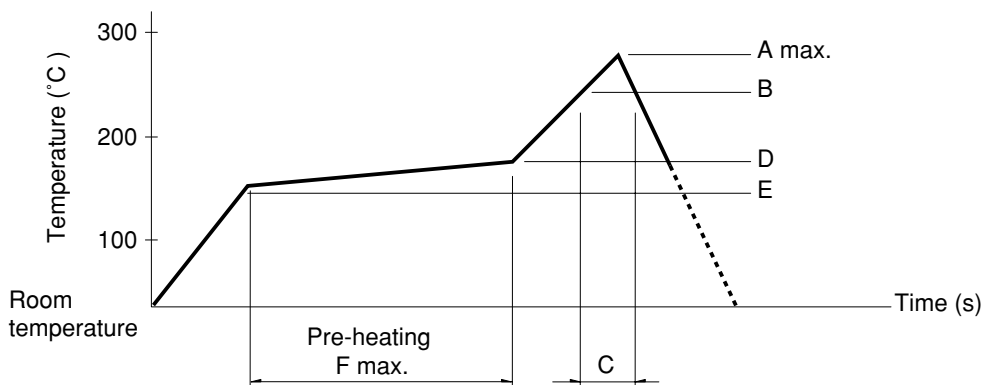

Series(Reflow type)	A() 3s max.	B()	C(s)	D()	E()	F(s)
RKJXS	260	230	40	150	150	120
SLLB, SLLB5	240		20			
SKRV/SKRH/SKQUBA,DB/SSAF/SRBE	260		40	180		

Notes

1. The above temperature shall be measured on the mounting surface of a PC board. There are cases where the PC board's temperature greatly differs from that of the switch, depending on the material, size thickness of PC boards and others. The above-stated conditions shall also apply to switch surface temperatures.
2. Soldering conditions differ depending on reflow soldering machines. Prior verification of soldering condition is highly recommended.