

## High voltage fast-switching NPN power transistor

Datasheet - production data

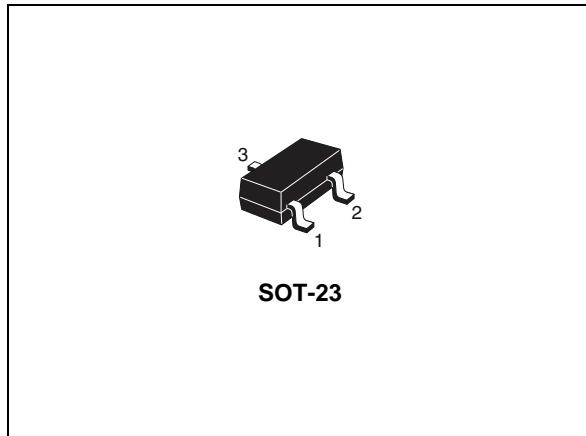

### Features

- Excellent  $h_{FE}$  linearity up to 50 mA
- Miniature SOT-23 plastic package for surface mounting circuits
- Tape and reel packaging
- The PNP complementary type is STR2550

### Applications

- LED driving

### Description

This device is a high voltage fast-switching NPN power transistor, manufactured using diffused collector planar technology for high switching speeds.

It employs a base island structure with planar edge termination to enhance switching speeds, while maintaining a wide RBSOA.

Figure 1. Internal schematic diagram

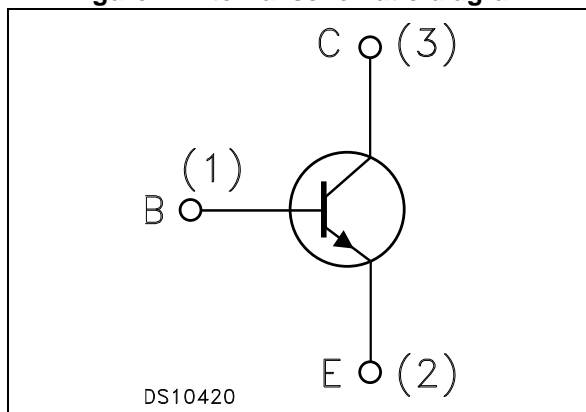

Table 1. Device summary

Order code	Marking	Package	Packing
STR1550	R1550	SOT-23	Tape and reel

# Contents

<b>1</b>	<b>Electrical ratings</b> .....	<b>3</b>
<b>2</b>	<b>Electrical characteristics</b> .....	<b>4</b>
	2.1 Electrical characteristics (curves) .....	5
<b>3</b>	<b>Package mechanical data</b> .....	<b>7</b>
<b>4</b>	<b>Revision history</b> .....	<b>10</b>

# 1 Electrical ratings

**Table 2. Absolute maximum ratings**

Symbol	Parameter	Value	Unit
$V_{CBO}$	Collector-base voltage ( $I_E = 0$ )	500	V
$V_{CEO}$	Collector-emitter voltage ( $I_B = 0$ )	500	V
$V_{EBO}$	Emitter-base voltage ( $I_C = 0$ )	9	V
$I_C$	Collector current	0.5	A
$I_{CM}$	Collector peak current ( $t_p < 5$ ms)	1	A
$P_{TOT}$	Total dissipation at $T_{amb} = 25$ °C	500	mW
$T_{STG}$	Storage temperature	-65 to 150	°C
$T_J$	Max. operating junction temperature	150	°C

**Table 3. Thermal data**

Symbol	Parameter	Value	Unit
$R_{thJA}^{(1)}$	Thermal resistance junction-ambient max	250	°C/W

1. Device mounted on PCB area of 1 cm<sup>2</sup> .

## 2 Electrical characteristics

$T_{\text{case}} = 25\text{ °C}$  unless otherwise specified.

**Table 4. Electrical characteristics**

Symbol	Parameter	Test conditions	Min.	Typ.	Max.	Unit
$I_{\text{CBO}}$	Collector cut-off current ( $I_{\text{E}} = 0$ )	$V_{\text{CB}} = 500\text{ V}$			10	$\mu\text{A}$
$V_{(\text{BR})\text{CBO}}$	Collector-base breakdown voltage ( $I_{\text{E}} = 0$ )	$I_{\text{C}} = 100\ \mu\text{A}$	500			V
$V_{(\text{BR})\text{CEO}}^{(1)}$	Collector-emitter breakdown voltage ( $I_{\text{B}} = 0$ )	$I_{\text{C}} = 1\text{ mA}$	500			V
$V_{(\text{BR})\text{EBO}}$	Emitter-base breakdown voltage ( $I_{\text{C}} = 0$ )	$I_{\text{E}} = 100\ \mu\text{A}$	12			V
$V_{\text{CE}(\text{sat})}^{(1)}$	Collector-emitter saturation voltage	$I_{\text{C}} = 20\text{ mA}$ , $I_{\text{B}} = 2\text{ mA}$			0.2	V
		$I_{\text{C}} = 50\text{ mA}$ , $I_{\text{B}} = 6\text{ mA}$			0.3	V
$V_{\text{BE}(\text{sat})}^{(1)}$	Base-emitter saturation voltage	$I_{\text{C}} = 50\text{ mA}$ , $I_{\text{B}} = 5\text{ mA}$			0.9	V
$V_{\text{BE}(\text{on})}$	Base-emitter on voltage	$I_{\text{C}} = 50\text{ mA}$ , $V_{\text{CE}} = 10\text{ V}$			0.9	V
$h_{\text{FE}}^{(1)}$	DC current gain	$I_{\text{C}} = 1\text{ mA}$ , $V_{\text{CE}} = 10\text{ V}$	100			
		$I_{\text{C}} = 50\text{ mA}$ , $V_{\text{CE}} = 10\text{ V}$	100		300	
		$I_{\text{C}} = 100\text{ mA}$ , $V_{\text{CE}} = 10\text{ V}$	10			

1. Pulse test: pulse duration  $\leq 300\ \mu\text{s}$ , duty cycle  $\leq 2\%$

## 2.1 Electrical characteristics (curves)

Figure 2.  $h_{FE}$  vs.  $I_C$  @  $V_{CE}=5\text{ V}$

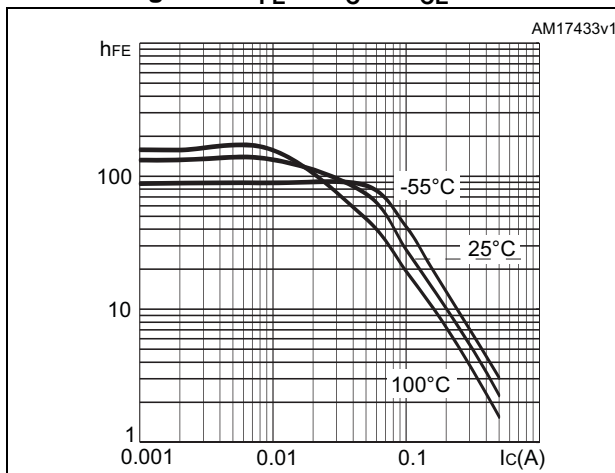

Figure 3.  $h_{FE}$  vs.  $I_C$  @  $V_{CE}=10\text{ V}$

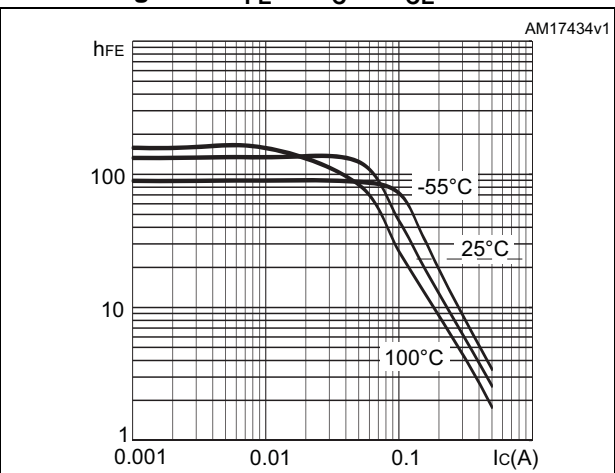

Figure 4.  $V_{CE(sat)}$  vs.  $I_C$  @  $h_{FE}=5$

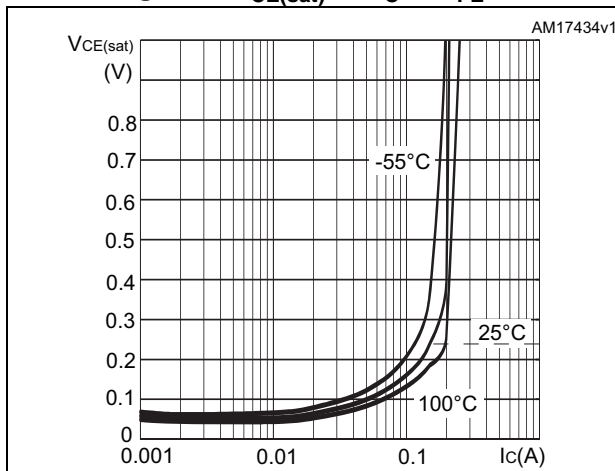

Figure 5.  $V_{CE(sat)}$  vs.  $I_C$  @  $h_{FE}=10$

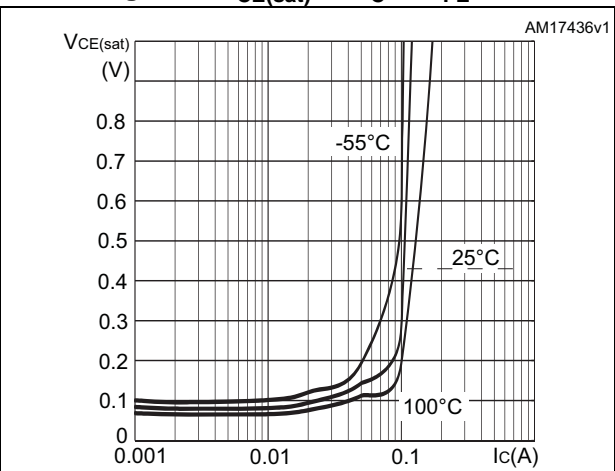

Figure 6.  $V_{BE(sat)}$  vs.  $I_C$  @  $h_{FE}=5$

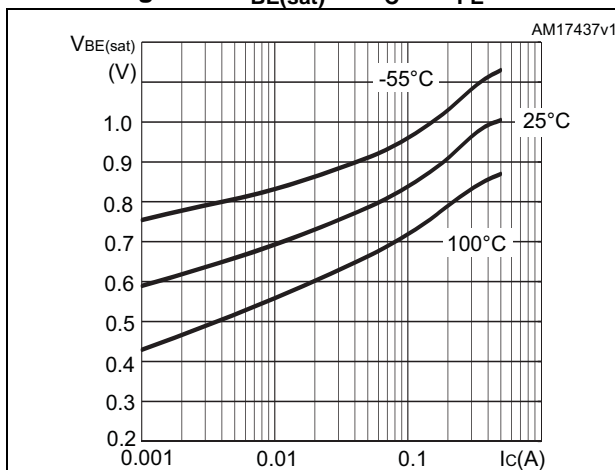

Figure 7.  $V_{BE(sat)}$  vs.  $I_C$  @  $h_{FE}=10$

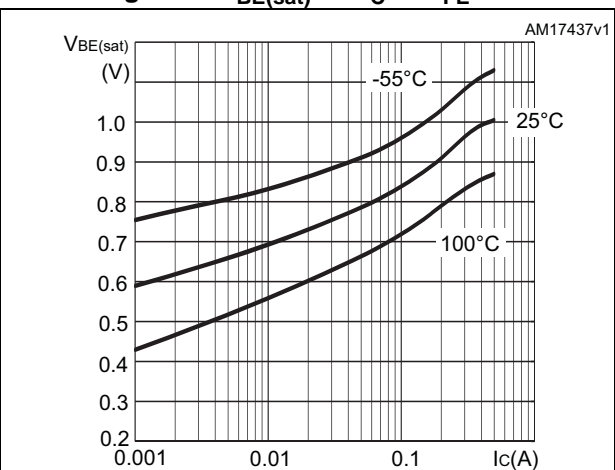
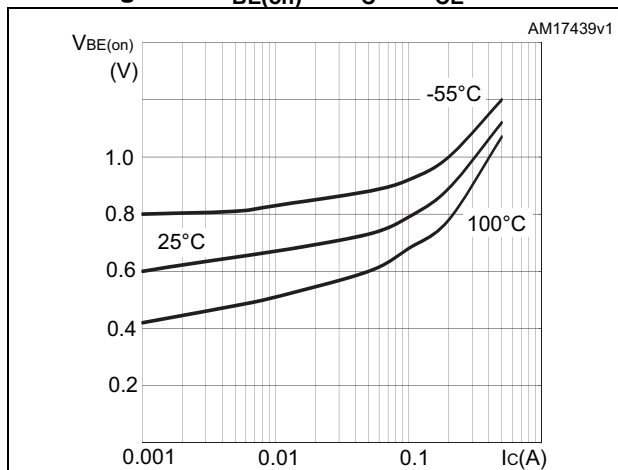

Figure 8.  $V_{BE(on)}$  vs.  $I_C$  @  $V_{CE}=10\text{ V}$



### 3 Package mechanical data

In order to meet environmental requirements, ST offers these devices in different grades of ECOPACK<sup>®</sup> packages, depending on their level of environmental compliance. ECOPACK<sup>®</sup> specifications, grade definitions and product status are available at: [www.st.com](http://www.st.com). ECOPACK<sup>®</sup> is an ST trademark.

Table 5. SOT-23 mechanical data

Dim.	mm		
	Min.	Typ.	Max.
A	0.89		1.40
A1	0		0.10
B	0.30		0.51
C	0.085		0.18
D	2.75		3.04
e	0.85		1.05
e1	1.70		2.10
E	1.20		1.75
H	2.10		3.00
L		0.60	
S	0.35		0.65
L1	0.25		0.55
a	0°		8°

Figure 9. SOT-23 drawings

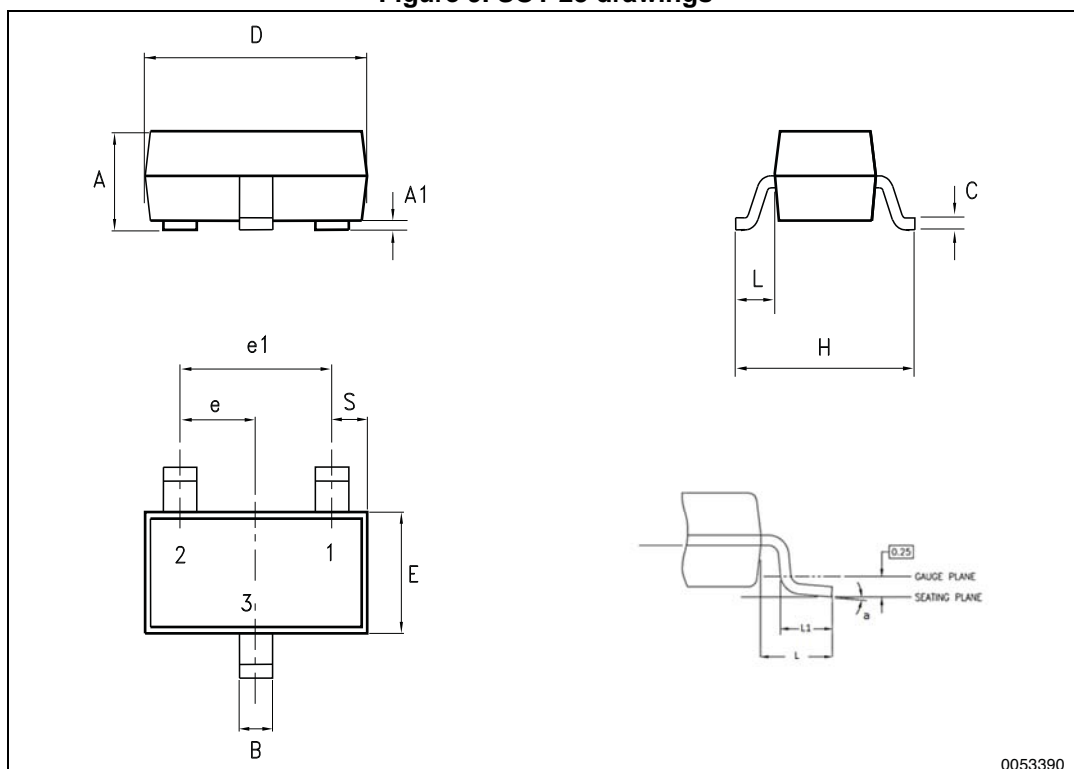
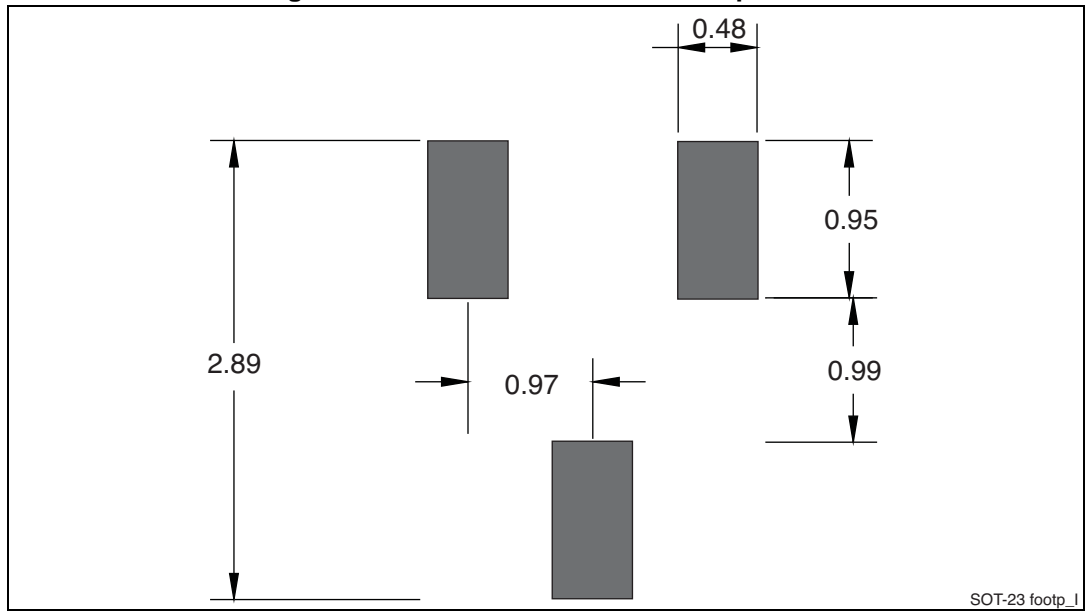



Figure 10. SOT-23 recommended footprint (a)



a. Dimensions are in mm.

## 4 Revision history

**Table 6. Document revision history**

Date	Revision	Changes
17-Oct-2011	1	Initial release
05-Jun-2012	2	Modified: features, <a href="#">Table 4</a> ( $V_{CE(sat)}$ values, $h_{FE}$ test conditions and values)
21-May-2013	3	<ul style="list-style-type: none"><li>– Modified: <a href="#">Table 4</a> (<math>V_{BE(sat)}</math> values, <math>h_{FE}</math> max. value and <math>V_{(BR)EBO}</math> min. value</li><li>– Inserted: <math>V_{BE(on)}</math></li><li>– Modified: <a href="#">Table 4</a> (<math>h_{FE}</math> max. value)</li><li>– Added new section: <a href="#">Electrical characteristics (curves)</a></li></ul>
27-May-2013	4	– Document status promoted from preliminary to production data

**Please Read Carefully:**

Information in this document is provided solely in connection with ST products. STMicroelectronics NV and its subsidiaries ("ST") reserve the right to make changes, corrections, modifications or improvements, to this document, and the products and services described herein at any time, without notice.

All ST products are sold pursuant to ST's terms and conditions of sale.

Purchasers are solely responsible for the choice, selection and use of the ST products and services described herein, and ST assumes no liability whatsoever relating to the choice, selection or use of the ST products and services described herein.

No license, express or implied, by estoppel or otherwise, to any intellectual property rights is granted under this document. If any part of this document refers to any third party products or services it shall not be deemed a license grant by ST for the use of such third party products or services, or any intellectual property contained therein or considered as a warranty covering the use in any manner whatsoever of such third party products or services or any intellectual property contained therein.

**UNLESS OTHERWISE SET FORTH IN ST'S TERMS AND CONDITIONS OF SALE ST DISCLAIMS ANY EXPRESS OR IMPLIED WARRANTY WITH RESPECT TO THE USE AND/OR SALE OF ST PRODUCTS INCLUDING WITHOUT LIMITATION IMPLIED WARRANTIES OF MERCHANTABILITY, FITNESS FOR A PARTICULAR PURPOSE (AND THEIR EQUIVALENTS UNDER THE LAWS OF ANY JURISDICTION), OR INFRINGEMENT OF ANY PATENT, COPYRIGHT OR OTHER INTELLECTUAL PROPERTY RIGHT.**

**ST PRODUCTS ARE NOT AUTHORIZED FOR USE IN WEAPONS. NOR ARE ST PRODUCTS DESIGNED OR AUTHORIZED FOR USE IN: (A) SAFETY CRITICAL APPLICATIONS SUCH AS LIFE SUPPORTING, ACTIVE IMPLANTED DEVICES OR SYSTEMS WITH PRODUCT FUNCTIONAL SAFETY REQUIREMENTS; (B) AERONAUTIC APPLICATIONS; (C) AUTOMOTIVE APPLICATIONS OR ENVIRONMENTS, AND/OR (D) AEROSPACE APPLICATIONS OR ENVIRONMENTS. WHERE ST PRODUCTS ARE NOT DESIGNED FOR SUCH USE, THE PURCHASER SHALL USE PRODUCTS AT PURCHASER'S SOLE RISK, EVEN IF ST HAS BEEN INFORMED IN WRITING OF SUCH USAGE, UNLESS A PRODUCT IS EXPRESSLY DESIGNATED BY ST AS BEING INTENDED FOR "AUTOMOTIVE, AUTOMOTIVE SAFETY OR MEDICAL" INDUSTRY DOMAINS ACCORDING TO ST PRODUCT DESIGN SPECIFICATIONS. PRODUCTS FORMALLY ESCC, QML OR JAN QUALIFIED ARE DEEMED SUITABLE FOR USE IN AEROSPACE BY THE CORRESPONDING GOVERNMENTAL AGENCY.**

Resale of ST products with provisions different from the statements and/or technical features set forth in this document shall immediately void any warranty granted by ST for the ST product or service described herein and shall not create or extend in any manner whatsoever, any liability of ST.

ST and the ST logo are trademarks or registered trademarks of ST in various countries.

Information in this document supersedes and replaces all information previously supplied.

The ST logo is a registered trademark of STMicroelectronics. All other names are the property of their respective owners.

© 2013 STMicroelectronics - All rights reserved

STMicroelectronics group of companies

Australia - Belgium - Brazil - Canada - China - Czech Republic - Finland - France - Germany - Hong Kong - India - Israel - Italy - Japan - Malaysia - Malta - Morocco - Philippines - Singapore - Spain - Sweden - Switzerland - United Kingdom - United States of America

[www.st.com](http://www.st.com)

