

**KEMET Part Number: SSHB21H-R12296**  
(UALSB2R1229600)

KEMET, SSHB21H, AC Line Filters, Dual Mode, 0.0296 H

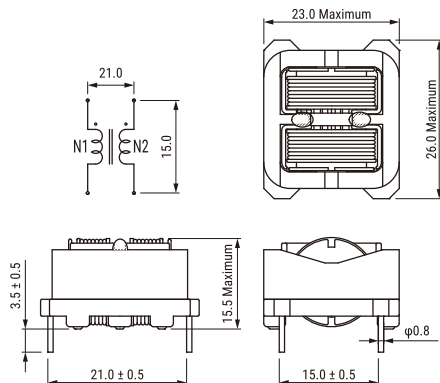

#### Dimensions

<b>L</b>	26mm MAX
<b>T</b>	23mm MAX
<b>H</b>	15.5mm MAX
<b>LL</b>	3.5mm +/-0.5mm
<b>S</b>	21mm +/-0.5mm

#### Packaging Specifications

<b>Packaging:</b>	Tray
<b>Packaging Quantity:</b>	360
<b>Weight:</b>	14 g

#### General Information

<b>Series:</b>	SSHB21H
<b>Style:</b>	Through-Hole
<b>RoHS:</b>	Yes
<b>Notes:</b>	Marking: R12 Lot No.
<b>Miscellaneous:</b>	Temperature Rise Maximum: 70 K

#### Specifications

<b>Voltage AC:</b>	250 VAC
<b>Inductance:</b>	29.6 mH (10 kHz)
<b>Current:</b>	1.2 A
<b>Temperature Range:</b>	-25/+120°C
<b>DC Resistance:</b>	490 mOhms